

Art. 515.3580

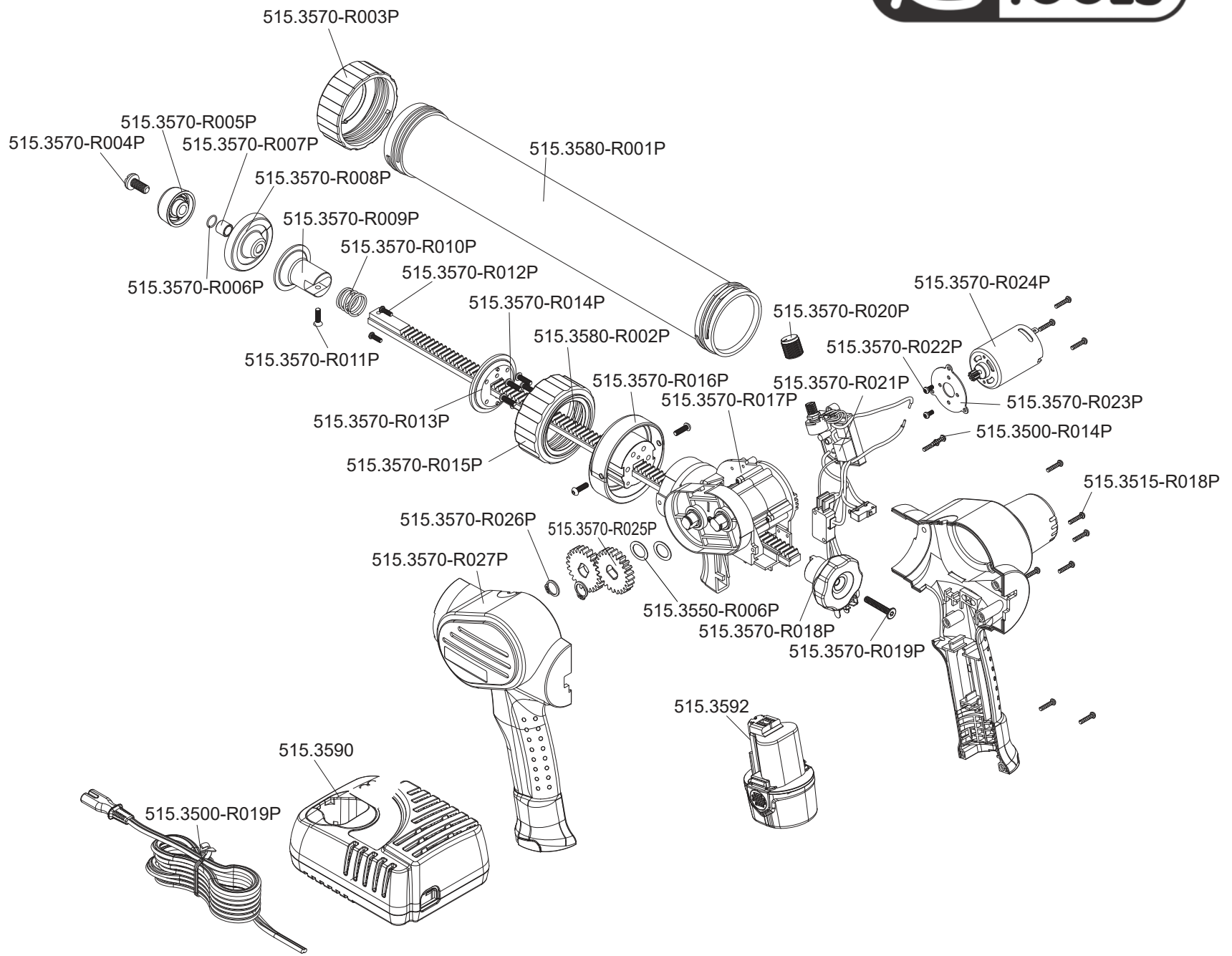

Art. 515.3580

Art.-Nr.	Description	Beschreibung	Menge Qty.
515.3500-R014P	Rear housing screw	Hintere Gehäuseschraube	5
515.3500-R019P	Power cord	Stromkabel	1
515.3515-R018P	Housing screw	Gehäuseschraube	8
515.3550-R006P	Washer	Unterlegscheibe	2
515.3570-R003P	Cartridge tube cap	Kartuschenrohrdeckel	1
515.3570-R004P	Plunger disc screw	Schubtellerschraube	1
515.3570-R005P	Pushing block	Schubteller	1
515.3570-R006P	O-Ring	O-Ring	1
515.3570-R007P	Bushing	Buchse	1
515.3570-R008P	Plunger disc	Schubteller	1
515.3570-R009P	Plunger disc mounting	Schubtelleraufnahme	1
515.3570-R010P	Plunger plate spring	Schubtellerfeder	1
515.3570-R011P	Plunger plate screw	Schubtellerschraube	1
515.3570-R012P	Screw	Schraube	3
515.3570-R013P	Rear plate	Abschlussplatte	1
515.3570-R014P	Screw	Schraube	7

Art.-Nr.	Description	Beschreibung	Menge Qty.
515.3570-R015P	Rear cartridge ring	Aufnahmering Kartuschenrohr	1
515.3570-R016P	Closing cap	Abschlussring	1
515.3570-R017P	Gear box with rack guiding	Getriebe mit Zahnstangenführung	1
515.3570-R018P	Rear knob	Schubstangengriff	1
515.3570-R019P	Screw for rear knob	Schraube für Schubstangengriff	1
515.3570-R020P	Speed regulator	Vorschubregulierung	1
515.3570-R021P	Main switch with PCB	Hauptschalter und Platine	1
515.3570-R022P	Screw for motor	Motorschraube	2
515.3570-R023P	Motor bracket ring	Motorhaltering	1
515.3570-R024P	Electric motor	Elektromotor	1
515.3570-R025P	Gear	Zahnrad	2
515.3570-R026P	Circlip	Seegerring	2
515.3570-R027P	Housing left + right	Gehäuse Links + Rechts	1
515.3580-R001P	Cartridge tube 600ml	Kartuschenrohr 600ml	1
515.3580-R002P	Rack 600ml	Zahnstange 600ml	1