

# P10

**workshop tool trolley**  
with 271 tools for 6 drawers  
**810.6271**

---

**Workshop trolley P10**

with 8 compartments

873.0008

# THE ENTRY MODEL TO SATISFY HIGH STANDARDS



P10



**DUO Lock** Brilliant locking system



**Eight drawers** each load capacity up to 50 kg



Stable **ball bearing**



**Stainless steel surface**



**Lock** lockable



**Anti-static castors** with brakes



Integrated **corner protection**



**Paper roll holder** included



**Can holder** included

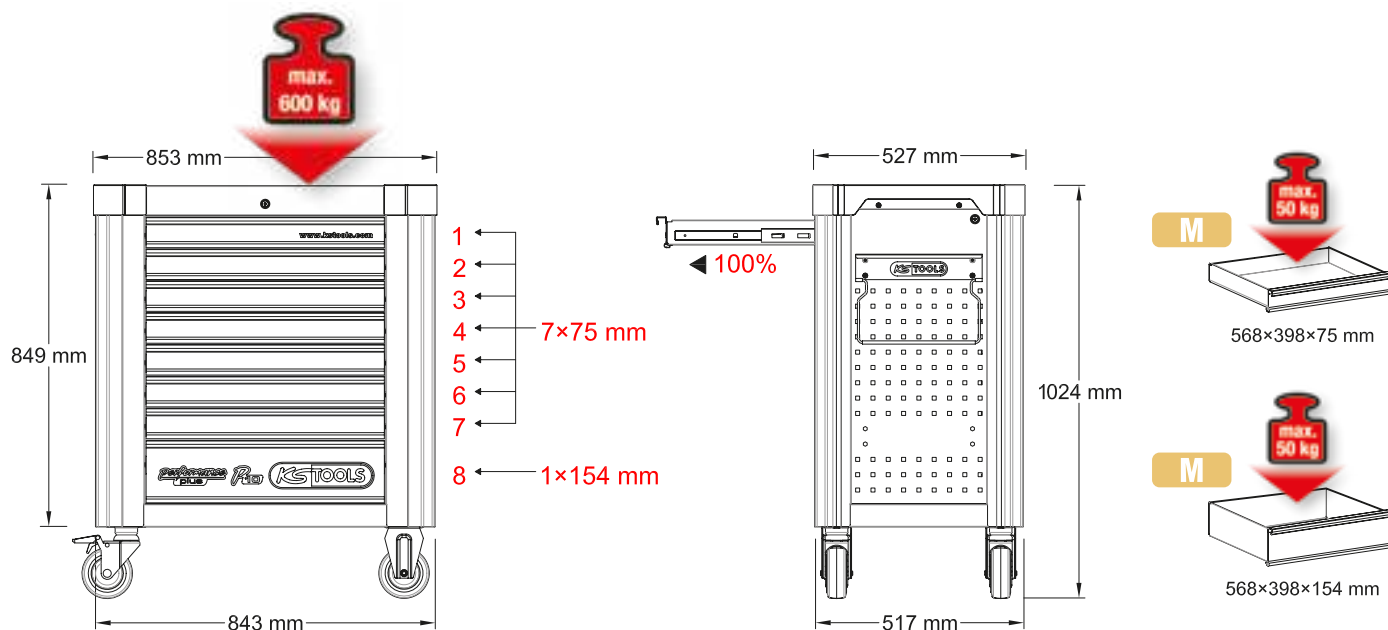

# P10 workshop tool trolley set with 271 tools for 6 drawers

810.6271



M

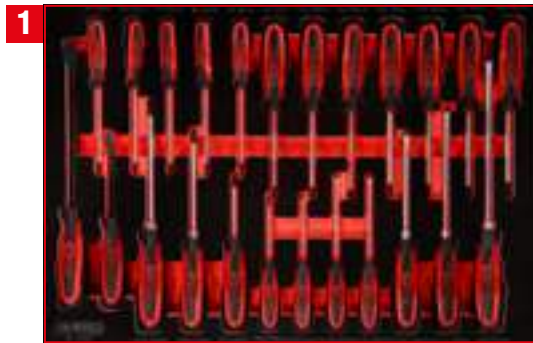

Screwdriver set in foam insert

811.0024



1/4" + 3/8" + 1/2" socket spanner set  
in foam insert

811.0139



Screw spanner set in foam insert

811.0053

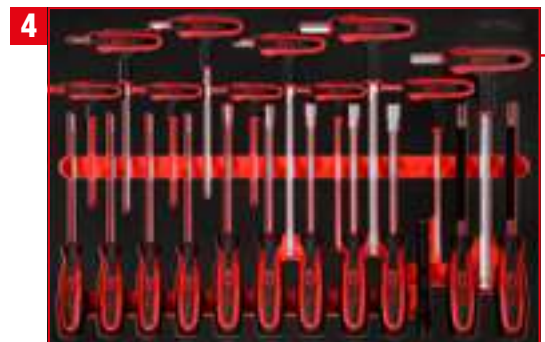

T-handle and screwdriver set in foam  
insert

811.1022



Spanner set in foam insert

811.0012



Hammer, chisel and file set in foam insert

811.0021

811.0024

**M** Screwdriver set

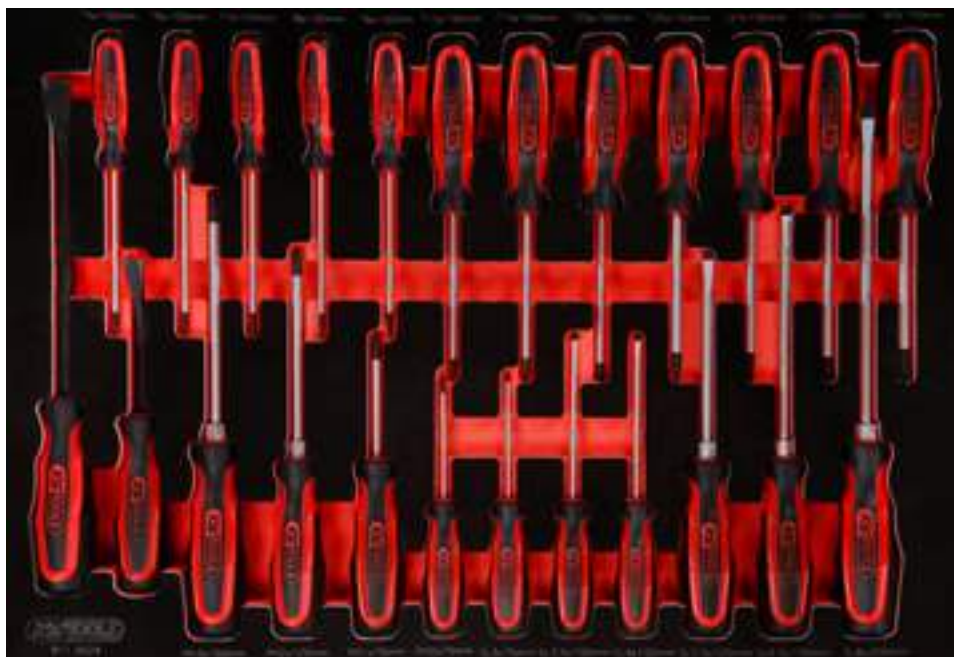

Pos.	Code	Description	pcs
1	911.8102	Pry bar, 15 x 185 mm	1
2	911.8101	Pry bar, 11 x 115 mm	1
3	159.1133	ERGOTORQUEplus screwdriver, Torx, T5	1
4	159.1134	ERGOTORQUEplus screwdriver, Torx, T6	1
5	159.1135	ERGOTORQUEplus screwdriver, Torx, T7	1
6	159.1030	ERGOTORQUEplus screwdriver, Torx, T8	1
7	159.1031	ERGOTORQUEplus screwdriver, Torx, T9	1
8	159.1032	ERGOTORQUEplus screwdriver, Torx, T10	1
9	159.1033	ERGOTORQUEplus screwdriver, Torx, T15	1
10	159.1034	ERGOTORQUEplus screwdriver, Torx, T20	1
11	159.1035	ERGOTORQUEplus screwdriver, Torx, T25	1
12	159.1036	ERGOTORQUEplus screwdriver, Torx, T27	1
13	159.1037	ERGOTORQUEplus screwdriver, Torx, T30	1
14	159.1038	ERGOTORQUEplus screwdriver, Torx, T40	1
15	159.1024	ERGOTORQUEplus screwdriver, Torx, PH3, 265 mm	1
16	159.1022	ERGOTORQUEplus screwdriver, Torx, PH2, 230 mm	1
17	159.1020	ERGOTORQUEplus screwdriver, Torx, PH1, 180 mm	1
18	159.1027	ERGOTORQUEplus screwdriver, Torx, PH0, 155 mm	1
19	159.1002	ERGOTORQUEplus screwdriver for slotted screws, 3 mm, 155 mm	1
20	159.1112	ERGOTORQUEplus screwdriver for slotted screws, 3,5 mm, 180 mm	1
21	159.1004	ERGOTORQUEplus screwdriver for slotted screws, 4 mm, 180 mm	1
22	159.1006	ERGOTORQUEplus screwdriver for slotted screws, 5,5 mm, 230 mm	1
23	159.1009	ERGOTORQUEplus screwdriver for slotted screws, 6,5 mm, 255 mm	1
24	159.1011	ERGOTORQUEplus screwdriver for slotted screws, 8 mm, 315 mm	1

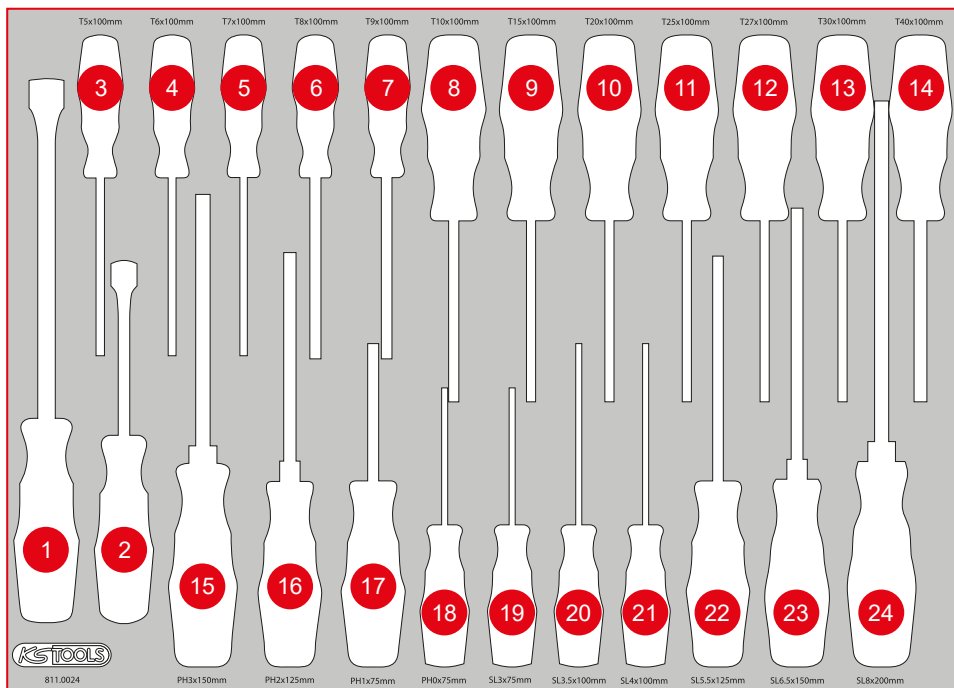

**M** 1/4" + 3/8" + 1/2" Socket spanner set

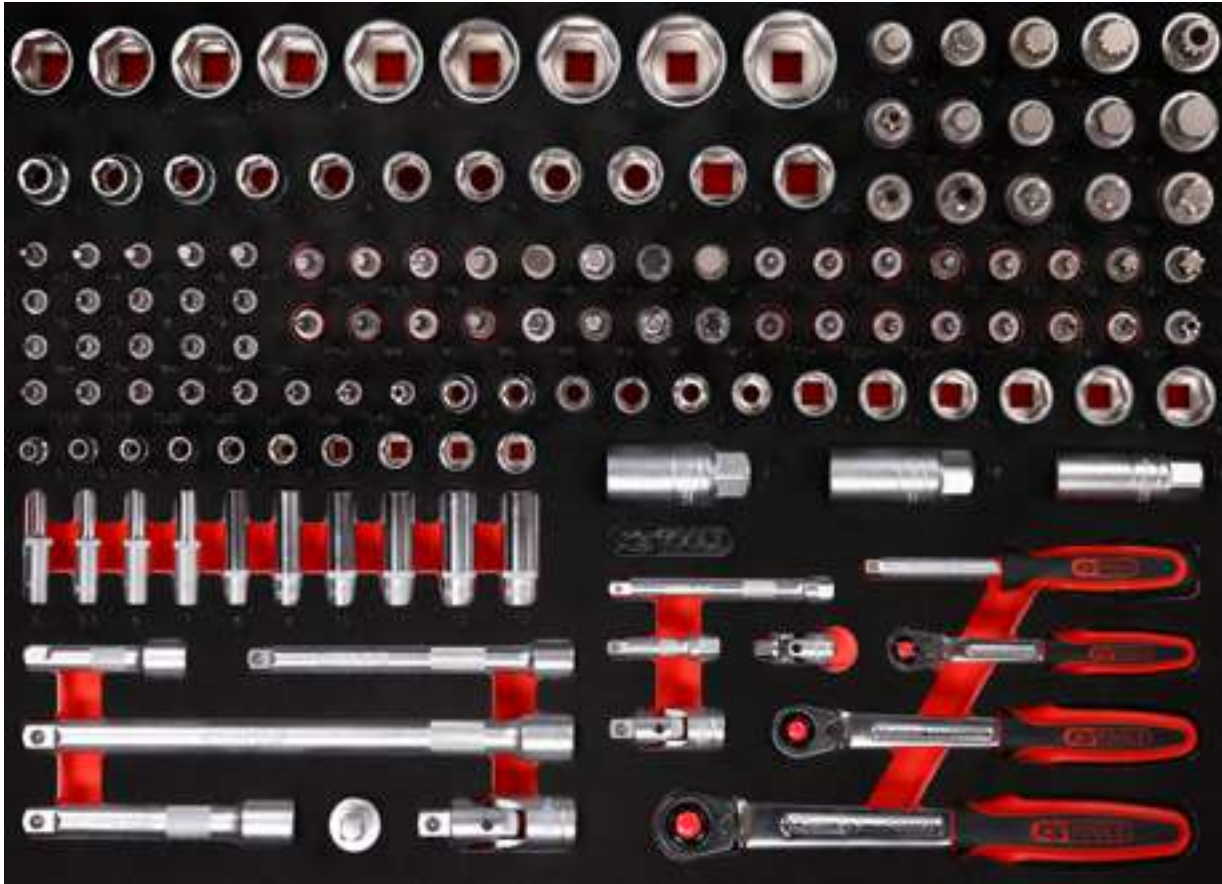
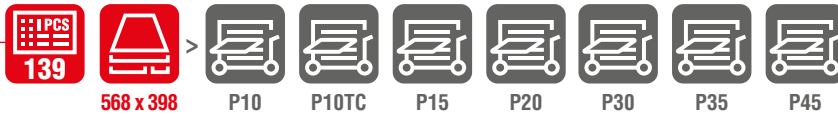

Pos.	Code	Description	pcs	Pos.	Code	Description	pcs	Pos.	Code	Description	pcs
1	917.1221	1/2" Hexagonal socket, 21 mm	1	25	911.1348	1/2" Bit socket spline (XZN) tamperproof, M16, 55 mm	1	48	911.1461	1/4" Bit socket Torx tamperproof, TB8	1
2	917.1222	1/2" Hexagonal socket, 22 mm	1	26	911.1378	1/2" Bit socket Torx tamperproof, TB55	1	49	911.1485	1/4" Bit socket Torx tamperproof, TB9	1
3	917.1223	1/2" Hexagonal socket, 23 mm	1	27	911.1310	1/2" Bit socket hexagon, short, 10 mm	1	50	911.1462	1/4" Bit socket Torx tamperproof, TB10	1
4	917.1224	1/2" Hexagonal socket, 24 mm	1	28	911.1312	1/2" Bit socket hexagon, short, 12 mm	1	51	911.1701	1/4" Bit socket five star tamperproof, TS10	1
5	917.1343	1/2" Hexagonal socket, 26 mm	1	29	911.1314	1/2" Bit socket hexagon, short, 14 mm	1	52	911.1702	1/4" Bit socket five star tamperproof, TS15	1
6	917.1227	1/2" Hexagonal socket, 27 mm	1	30	911.1317	1/2" Bit socket hexagon, short, 17 mm	1	53	911.1703	1/4" Bit socket five star tamperproof, TS20	1
7	917.1344	1/2" Hexagonal socket, 28 mm	1	31	911.1379	1/2" Bit socket Torx tamperproof, TB60	1	54	911.1704	1/4" Bit socket five star tamperproof, TS25	1
8	917.1230	1/2" Hexagonal socket, 30 mm	1	32	911.1380	1/2" Bit socket Torx tamperproof, TB70	1	55	911.1705	1/4" Bit socket five star tamperproof, TS27	1
9	917.1232	1/2" Hexagonal socket, 32 mm	1	33	911.1368	1/2" Bit socket Torx, T55	1	56	911.1706	1/4" Bit socket five star tamperproof, TS30	1
10	917.1210	1/2" Hexagonal socket, 10 mm	1	34	911.1369	1/2" Bit socket Torx, T60	1	57	911.1707	1/4" Bit socket five star tamperproof, TS40	1
11	917.1211	1/2" Hexagonal socket, 11 mm	1	35	911.1370	1/2" Bit socket Torx, T70	1	58	911.1708	1/4" Bit socket five star tamperproof, TS45	1
12	917.1212	1/2" Hexagonal socket, 12 mm	1	36	911.1436	1/4" Bit socket hexagon, 3 mm	1	59	911.3865	3/8" Bit socket hexagon, 5 mm	1
13	917.1213	1/2" Hexagonal socket, 13 mm	1	37	911.1437	1/4" Bit socket hexagon, 4 mm	1	60	911.38655	3/8" Bit socket hexagon, 5,5 mm	1
14	917.1214	1/2" Hexagonal socket, 14 mm	1	38	911.1438	1/4" Bit socket hexagon, 5 mm	1	61	911.3866	3/8" Bit socket hexagon, 6 mm	1
15	917.1215	1/2" Hexagonal socket, 15 mm	1	39	911.1439	1/4" Bit socket hexagon, 6 mm	1	62	911.3867	3/8" Bit socket hexagon, 7 mm	1
16	917.1216	1/2" Hexagonal socket, 16 mm	1	40	911.1440	1/4" Bit socket hexagon, 7 mm	1	63	911.3868	3/8" Bit socket hexagon, 8 mm	1
17	917.1217	1/2" Hexagonal socket, 17 mm	1	41	911.4407	1/4" Bit socket Torx, T6	1	64	917.3969	3/8" Bit socket hexagon, 9 mm	1
18	917.1218	1/2" Hexagonal socket, 18 mm	1	42	911.4362	1/4" Bit socket Torx, T7	1	65	917.3857	3/8" Bit socket hexagon, 10 mm	1
19	917.1219	1/2" Hexagonal socket, 19 mm	1	43	911.1448	1/4" Bit socket Torx, T8	1	66	911.3862	3/8" Bit socket hexagon, 12 mm	1
20	917.1220	1/2" Hexagonal socket, 20 mm	1	44	911.1478	1/4" Bit socket Torx, T9	1	67	911.3869	3/8" Bit socket Torx, T15	1
21	911.1343	1/2" Bit socket spline (XZN), M10, 55 mm	1	45	911.1442	1/4" Bit socket Torx, T10	1	68	911.3870	3/8" Bit socket Torx, T20	1
22	911.1344	1/2" Bit socket spline (XZN), M12, 55 mm	1	46	917.1456	1/4" Bit socket Torx tamperproof, TB6	1	69	911.3871	3/8" Bit socket Torx, T25	1
23	911.1345	1/2" Bit socket spline (XZN), M14, 55 mm	1	47	917.1457	1/4" Bit socket Torx tamperproof, TB7	1	70	911.3872	3/8" Bit socket Torx, T27	1
24	911.1346	1/2" Bit socket spline (XZN), M16, 55 mm	1					71	911.3873	3/8" Bit socket Torx, T30	1

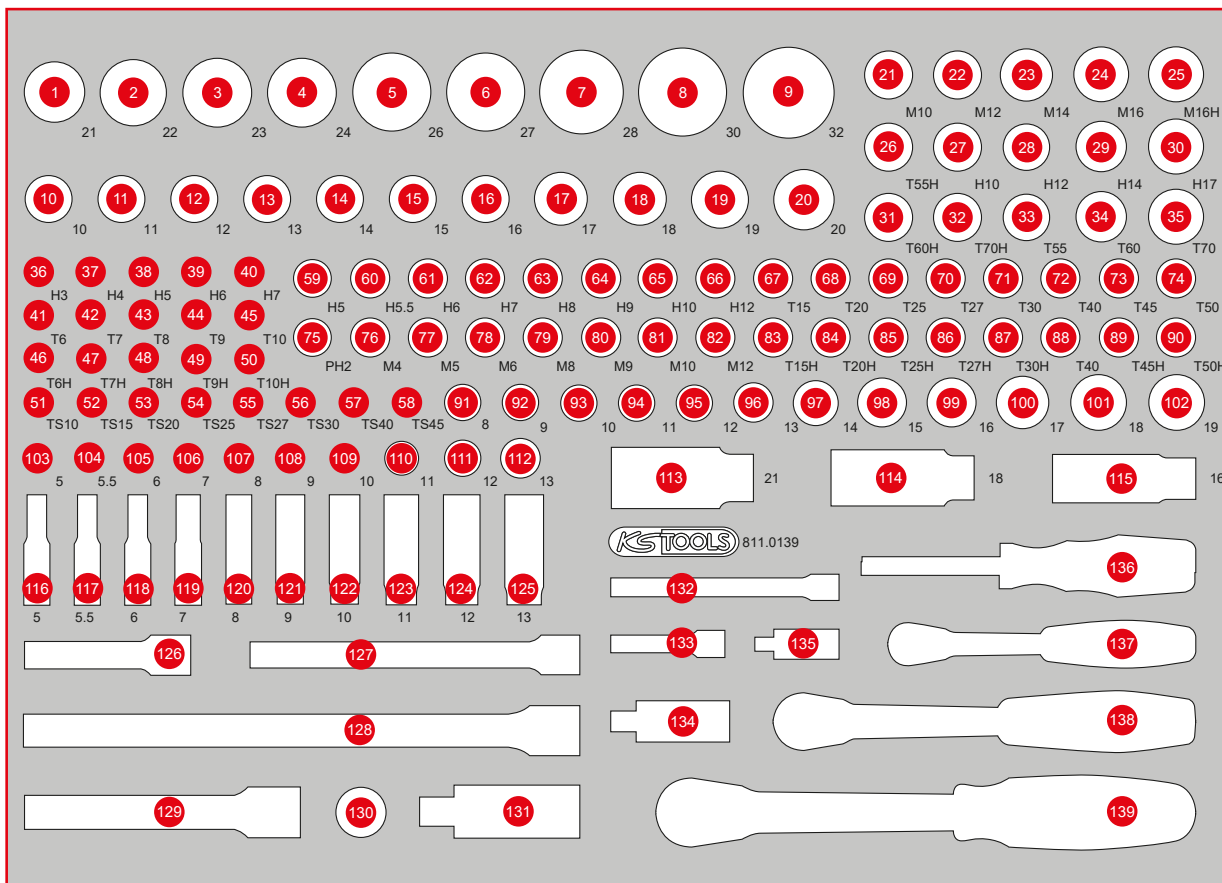

Pos.	Code	Description	pcs	Pos.	Code	Description	pcs	Pos.	Code	Description	pcs
72	911.3874	3/8" Bit socket Torx, T40	1	96	917.3813	3/8" Hexagonal socket, 13 mm	1	120	917.1428	1/4" Hexagonal socket, deep, 8 mm	1
73	911.3885	3/8" Bit socket Torx, T45	1	97	917.3814	3/8" Hexagonal socket, 14 mm	1	121	917.1429	1/4" Hexagonal socket, deep, 9 mm	1
74	911.3884	3/8" Bit socket Torx, T50	1	98	917.3815	3/8" Hexagonal socket, 15 mm	1	122	917.1430	1/4" Hexagonal socket, deep, 10 mm	1
75	911.3876	3/8" Bit socket, PH2	1	99	917.3816	3/8" Hexagonal socket, 16 mm	1	123	917.1431	1/4" Hexagonal socket, deep, 11 mm	1
76	911.3918	3/8" Bit socket spline (XZN), M4	1	100	917.3817	3/8" Hexagonal socket, 17 mm	1	124	917.1432	1/4" Hexagonal socket, deep, 12 mm	1
77	911.3915	3/8" Bit socket spline (XZN), M5	1	101	917.3818	3/8" Hexagonal socket, 18 mm	1	125	917.1433	1/4" Hexagonal socket, deep, 13 mm	1
78	911.3916	3/8" Bit socket spline (XZN), M6	1	102	917.3819	3/8" Hexagonal socket, 19 mm	1	126	911.3801	3/8" Extension with knurling, 75 mm	1
79	911.3917	3/8" Bit socket spline (XZN), M8	1	103	917.1405	1/4" Hexagonal socket, 5 mm	1	127	911.3802	3/8" Extension with knurling, 150 mm	1
80	917.3901	3/8" Bit socket spline (XZN), M9	1	104	917.14055	1/4" Hexagonal socket, 5,5 mm	1	128	911.1203	1/2" Extensions, 250 mm	1
81	911.3920	3/8" Bit socket spline (XZN), M10	1	105	917.1406	1/4" Hexagonal socket, 6 mm	1	129	911.1202	1/2" Extensions, 125 mm	1
82	917.3903	3/8" Bit socket spline (XZN), M12	1	106	917.1407	1/4" Hexagonal socket, 7 mm	1	130	911.1207	3/8" Sliding adaptor, 3/8" F x 1/2" M	1
83	911.3961	3/8" Bit socket Torx tamperproof, TB15	1	107	917.1408	1/4" Hexagonal socket, 8 mm	1	131	911.1250	1/2" Universal joint	1
84	911.3962	3/8" Bit socket Torx tamperproof, TB20	1	108	917.1409	1/4" Hexagonal socket, 9 mm	1	132	911.1424	1/4" Extension with hexagon drive, 100 mm	1
85	911.3963	3/8" Bit socket Torx tamperproof, TB25	1	109	917.1410	1/4" Hexagonal socket, 10 mm	1	133	911.1423	1/4" Extension with hexagon drive, 50 mm	1
86	911.3964	3/8" Bit socket Torx tamperproof, TB27	1	110	917.1411	1/4" Hexagonal socket, 11 mm	1	134	911.3850	3/8" Universal joint	1
87	911.3965	3/8" Bit socket Torx tamperproof, TB30	1	111	917.1412	1/4" Hexagonal socket, 12 mm	1	135	911.1450	1/4" Universal joint	1
88	911.3966	3/8" Bit socket Torx tamperproof, TB40	1	112	917.1413	1/4" Hexagonal socket, 13 mm	1	136	911.1434	1/4" Square drive screwdriver, 150 mm	1
89	911.3967	3/8" Bit socket Torx tamperproof, TB45	1	113	911.3805	3/8" Spark plug socket, 21 mm	1	137	920.1490	1/4" SlimPOWER Reversible ratchet, 72 teeth	1
90	911.3968	3/8" Bit socket Torx tamperproof, TB50	1	114	911.3823	3/8" Spark plug socket, 18 mm	1	138	920.3890	3/8" SlimPOWER Reversible ratchet, 72 teeth	1
91	917.3808	3/8" Hexagonal socket, 8 mm	1	115	911.3804	3/8" Spark plug socket, 16 mm	1	139	920.1290	1/2" SlimPOWER Reversible ratchet, 72 teeth	1
92	917.3809	3/8" Hexagonal socket, 9 mm	1	116	917.1527	1/4" Hexagonal socket, deep, 5 mm	1				
93	917.3810	3/8" Hexagonal socket, 10 mm	1	117	917.1528	1/4" Hexagonal socket, deep, 5,5 mm	1				
94	917.3811	3/8" Hexagonal socket, 11 mm	1	118	917.1426	1/4" Hexagonal socket, deep, 6 mm	1				
95	917.3812	3/8" Hexagonal socket, 12 mm	1	119	917.1427	1/4" Hexagonal socket, deep, 7 mm	1				

811.0053

## M Screw spanner set



568 x 398

P10

P10TC

P15

P20

P30

P35

P45



Pos.	Code	Description	pcs	Pos.	Code	Description	pcs	Pos.	Code	Description	pcs
1	517.0606	Combination spanners, offset, 6 mm	1	12	517.0617	Combination spanners, offset, 17 mm	1	22	911.0373	Double ring spanner for Torx E profile, E10 x E12	1
2	517.0607	Combination spanners, offset, 7 mm	1	13	517.0618	Combination spanners, offset, 18 mm	1	23	911.0374	Double ring spanner for Torx E profile, E14 x E18	1
3	517.0608	Combination spanners, offset, 8 mm	1	14	517.0619	Combination spanners, offset, 19 mm	1	24	911.0375	Double ring spanner for Torx E profile, E16 x E22	1
4	517.0609	Combination spanners, offset, 9 mm	1	15	517.0620	Combination spanners, offset, 20 mm	1	25	911.0376	Double ring spanner for Torx E profile, E20 x E24	1
5	517.0610	Combination spanners, offset, 10 mm	1	16	517.0621	Combination spanners, offset, 21 mm	1	26	517.0252	Open double ring spanner, offset, 8 x 10 mm	1
6	517.0611	Combination spanners, offset, 11 mm	1	17	517.0622	Combination spanners, offset, 22 mm	1	27	517.9244	Open double ring spanner, offset, 11 x 13 mm	1
7	517.0612	Combination spanners, offset, 12 mm	1	18	517.0623	Combination spanners, offset, 23 mm	1	28	517.0258	Open double ring spanner, offset, 12 x 14 mm	1
8	517.0613	Combination spanners, offset, 13 mm	1	19	517.0624	Combination spanners, offset, 24 mm	1	29	517.0263	Open double ring spanner, offset, 16 x 18 mm	1
9	517.0614	Combination spanners, offset, 14 mm	1	20	911.0371	Double ring spanner for Torx E profile, E6 x E8	1	30	517.0264	Open double ring spanner, offset, 17 x 19 mm	1
10	517.0615	Combination spanners, offset, 15 mm	1	21	911.0372	Double ring spanner for Torx E profile, E7 x E11	1				
11	517.0616	Combination spanners, offset, 16 mm	1								

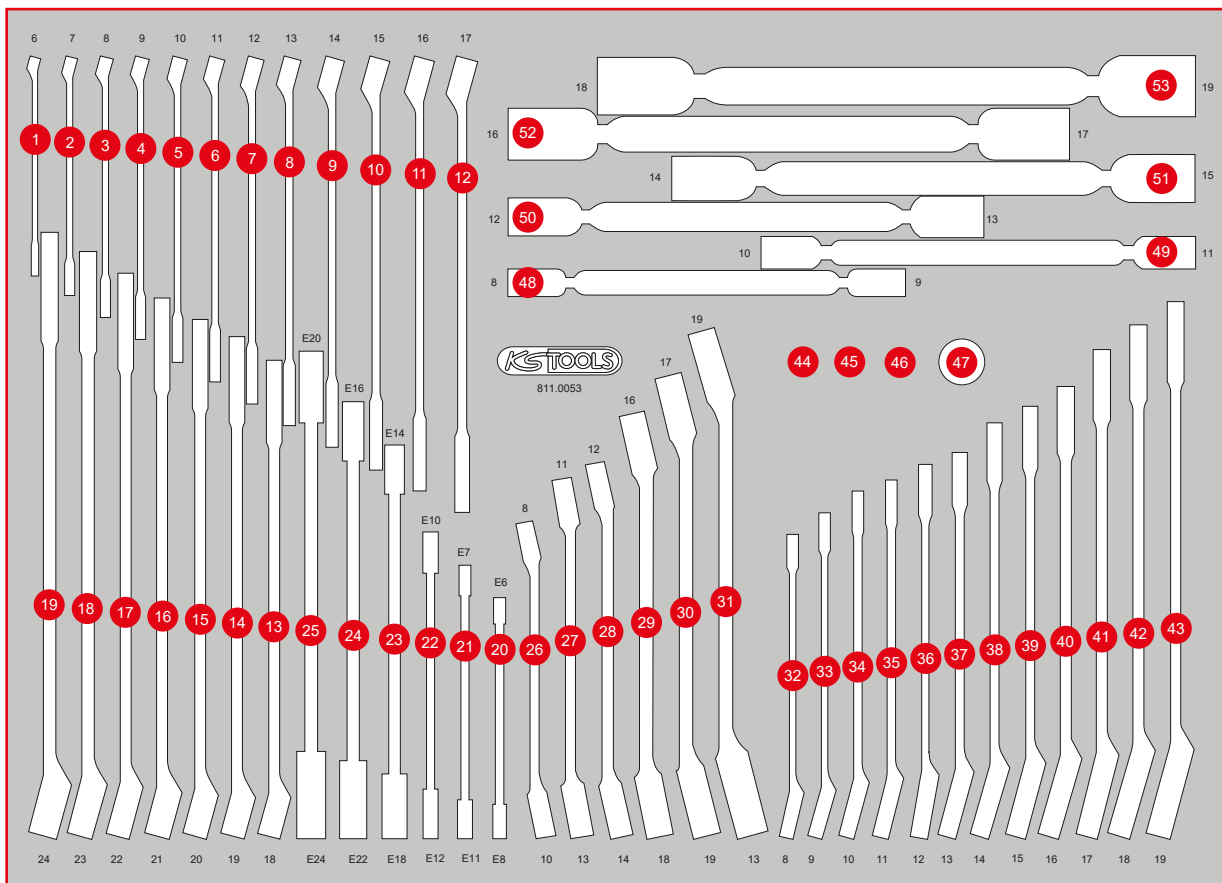

Pos.	Code	Description	pcs	Pos.	Code	Description	pcs	Pos.	Code	Description	pcs
31	517.0266	Open double ring spanner, offset, 19 x 22 mm	1	39	503.4615	GEARplus reversing combination ratcheting spanner, 15 mm	1	47	503.4298	GEARplus socket adaptor, 1/2" x 19 mm	1
32	503.4608	GEARplus reversing combination ratcheting spanner, 8 mm	1	40	503.4616	GEARplus reversing combination ratcheting spanner, 16 mm	1	48	517.0301	Double revolving head spanner, 8 x 9 mm	1
33	503.4609	GEARplus reversing combination ratcheting spanner, 9 mm	1	41	503.4617	GEARplus reversing combination ratcheting spanner, 17 mm	1	49	517.0302	Double revolving head spanner, 10 x 11 mm	1
34	503.4610	GEARplus reversing combination ratcheting spanner, 10 mm	1	42	503.4618	GEARplus reversing combination ratcheting spanner, 18 mm	1	50	517.0303	Double revolving head spanner, 12 x 13 mm	1
35	503.4611	GEARplus reversing combination ratcheting spanner, 11 mm	1	43	503.4619	GEARplus reversing combination ratcheting spanner, 19 mm	1	51	517.0304	Double revolving head spanner, 14 x 15 mm	1
36	503.4612	GEARplus reversing combination ratcheting spanner, 12 mm	1	44	503.4290	GEARplus bit adaptor, 1/4" x 10 mm	1	52	517.0305	Double revolving head spanner, 16 x 17 mm	1
37	503.4613	GEARplus reversing combination ratcheting spanner, 13 mm	1	45	503.4296	GEARplus socket adaptor, 1/4" x 10 mm	1	53	517.0306	Double revolving head spanner, 18 x 19 mm	1
38	503.4614	GEARplus reversing combination ratcheting spanner, 14 mm	1	46	503.4297	GEARplus socket adaptor, 3/8" x 13 mm	1				

**M** T-handle and screwdriver set

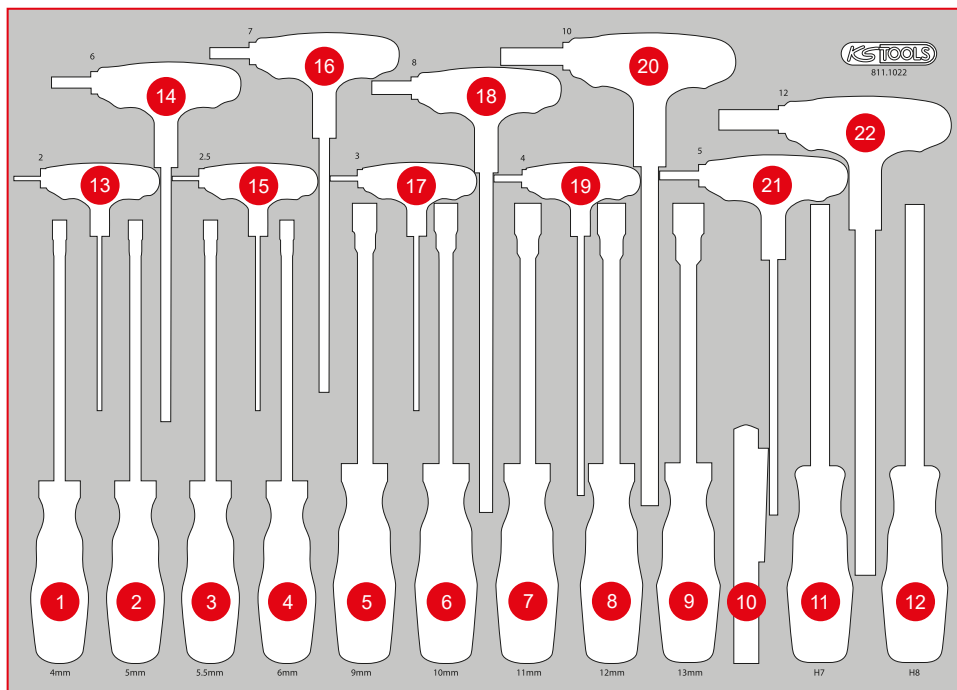

Pos.	Code	Description	pcs
1	159.1201	ERGOTORQUEplus Socket screwdriver, 4 mm	1
2	159.1202	ERGOTORQUEplus Socket screwdriver, 5 mm	1
3	159.1203	ERGOTORQUEplus Socket screwdriver, 5,5 mm	1
4	159.1204	ERGOTORQUEplus Socket screwdriver, 6 mm	1
5	159.1207	ERGOTORQUEplus Socket screwdriver, 9 mm	1
6	159.1208	ERGOTORQUEplus Socket screwdriver, 10 mm	1
7	159.1209	ERGOTORQUEplus Socket screwdriver, 11 mm	1
8	159.1210	ERGOTORQUEplus Socket screwdriver, 12 mm	1
9	159.1211	ERGOTORQUEplus Socket screwdriver, 13 mm	1
10	150.4370	perfectLight torch 85 lumen	1
11	159.1127	ERGOTORQUEplus Socket screwdriver, 7 mm	1
12	159.2128	ERGOTORQUEplus Socket screwdriver, 8 mm	1
13	151.8130	T-handle ball ended hexagon key wrench, 2 mm	1
14	151.8135	T-handle ball ended hexagon key wrench, 6 mm	1
15	151.8131	T-handle ball ended hexagon key wrench, 2,5 mm	1
16	151.8136	T-handle ball ended hexagon key wrench, 7 mm	1
17	151.8132	T-handle ball ended hexagon key wrench, 3 mm	1
18	151.8137	T-handle ball ended hexagon key wrench, 8 mm	1
19	151.8133	T-handle ball ended hexagon key wrench, 4 mm	1
20	151.8138	T-handle ball ended hexagon key wrench, 10 mm	1
21	151.8134	T-handle ball ended hexagon key wrench, 5 mm	1
22	151.8139	T-handle ball ended hexagon key wrench, 12 mm	1

811.0012

**M** Spanner set

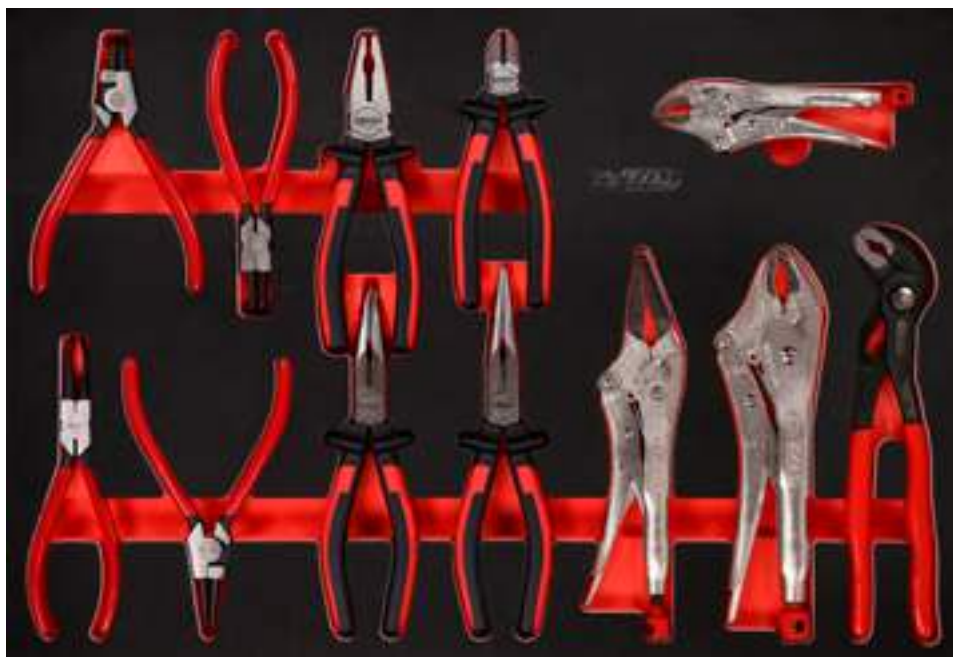

Pos.	Code	Description	pcs
1	115.1021	ERGOTORQUE combination pliers, 180 mm	1
2	115.1012	ERGOTORQUE diagonal side cutter, 160 mm	1
3	115.1019	ERGOTORQUE bent nose pliers serrated, 210 mm	1
4	115.1024	ERGOTORQUE long nose pliers serrated cutter, 200 mm	1
5	500.1026	Circlip pliers for external circlips, angled, 160 mm	1
6	500.1029	Circlip pliers for external circlips, 160 mm	1
7	500.1032	Circlip pliers for internal circlips, angled, 160 mm	1
8	500.1035	Circlip pliers for internal circlips, 160 mm	1
9	115.1031	Locking pliers, 50 mm, 140 mm	1
10	115.1035	Longbacken-Locking pliers, 210 mm	1
11	115.1033	Self grip wrench, 220 mm	1
12	115.2010	Water pump pliers, 240 mm	1

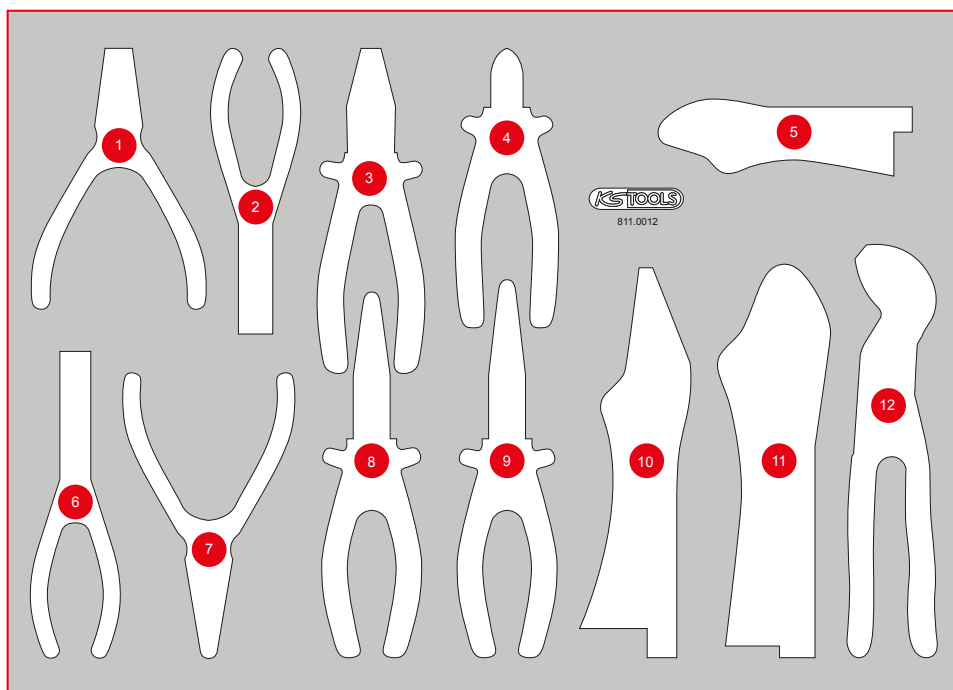

811.0021

**M** Hammer, chisel and file set



Pos.	Code	Description	pcs
1	140.5252	Recoil free soft faced Hammer, 400 g	1
2	142.1402	Fitters Hammer, fiberglas handle, 400 g	1
3	142.5101	Club Hammer, fiberglas handle, 1000 g	1
4	156.0242	Cross chisel, octagon, 7 mm	1
5	156.0234	Pin punch, Ø 6 mm, cylindrical shaft	1
6	156.0233	Pin punch, Ø 5 mm, cylindrical shaft	1
7	156.0232	Pin punch, cylindrical shaft, 4 mm	1
8	156.0231	Pin punch, cylindrical shaft, 3 mm	1
9	300.0510	Pocket vernier calliper 0-150 mm, 235 mm	1
10	157.0405	Tri-bastard file, form C, cut 2, 200 mm	1
11	157.0960	Brake saddle file, extra narrow, 270 mm	1
12	157.0205	Round file, form F, cut 2, 200 mm	1
13	156.0243	Centre punch, octagon 10 mm	1
14	156.0238	Punch, Ø 4 mm, conical	1
15	156.0237	Punch, Ø 3 mm, conical	1
16	156.0252	Flat chisel, octagon, 12 mm	1
17	156.0253	Flat chisel, octagon, 16 mm	1
18	156.0254	Flat chisel, octagon, 18 mm	1
19	156.0241	Flat chisel, octagon, 20 mm	1
20	201.2335	Steel wire brake saddle brush, 2-row, straight	1
21	300.0104	Flexible steel rule, 300 mm	1

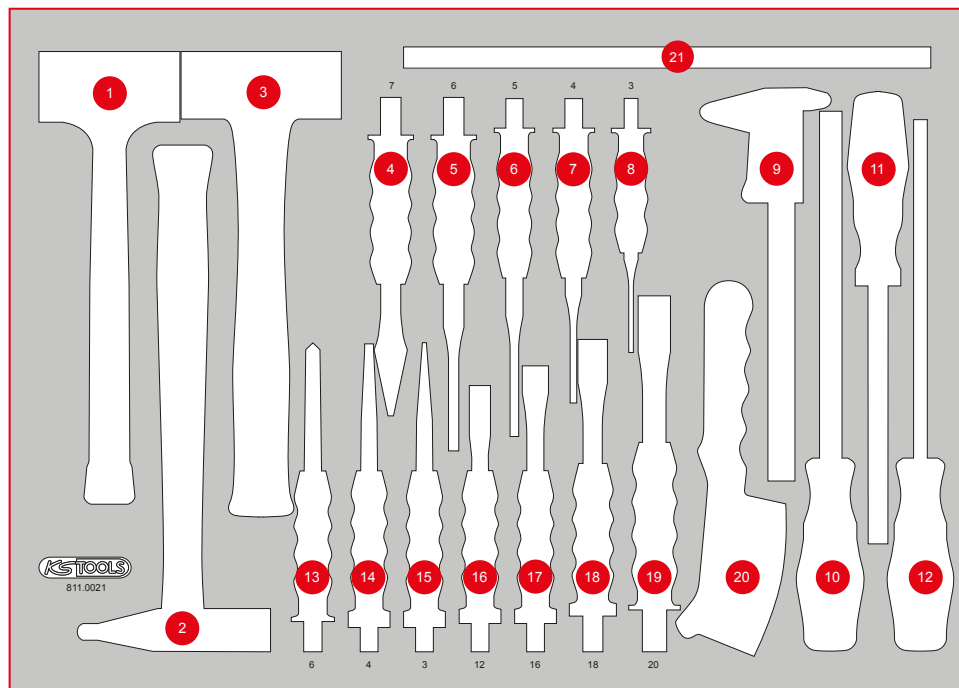

# P10

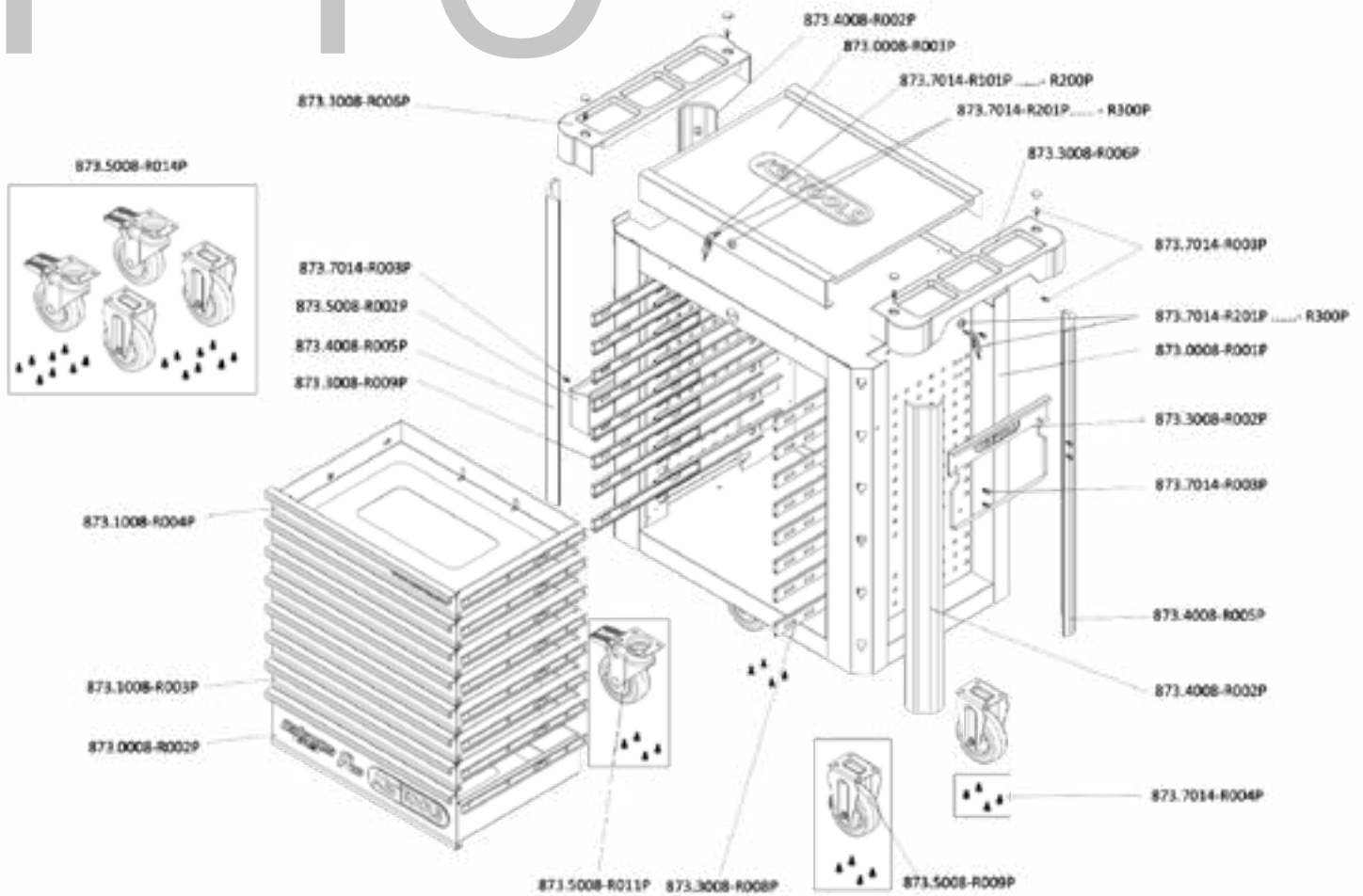

## INDIVIDUAL PARTS LIST

Item No.	Description	Amount
873.7014-R101P...	Replacement key for PERFORMANCEplus workshop trolley lock number xyz	2
873.7014-R201P...	Lock with 2 keys for PERFORMANCEplus workshop trolley lock number xyz	2
873.0008-R001P	Body with handle	1
873.0008-R002P	Compartment with logo and ball-bearing guide, 568x398x145 mm	1
873.0008-R003P	Stainless steel worktop	1
873.1008-R003P	Compartment with ball-bearing guide, for workshop trolley P10/P10TC/P15, 568x398x65 mm	6
873.1008-R004P	Compartment with website and ball-bearing guide, for workshop trolley P10/P15, 568x398x65 mm	1
873.3008-R002P	Paper roll holder for PERFORMANCEplus workshop trolley	1
873.3008-R006P	Storage for work surface	2
873.3008-R008P	Full extension (with ball-bearing guide) with automatic retraction	8
873.3008-R009P	Full extension (with ball-bearing guide) with automatic retraction	8
873.4008-R002P	Plastic bumpers	2
873.4008-R005P	Plastic bumpers	2
873.5008-R002P	Can holder for PERFORMANCEplus workshop trolley	1
873.5008-R009P	Fixed castors for PERFORMANCEplus workshop trolley, incl. screws	2
873.5008-R011P	Swivel castors with brakes, for PERFORMANCEplus workshop trolley, incl. screws	2
873.5008-R014P	Roller set for PERFORMANCEplus workshop trolley, incl. screws	1
873.7014-R003P	M6x12 screws for PERFORMANCEplus workshop trolley accessories	14
873.7014-R004P	M8 screws for PERFORMANCEplus workshop trolley rollers (16 pcs.)	1



**873.7014-R101P...R200P**  
Replacement key for lock number xyz



**873.7014-R201P...R300P**  
Lock with 2 keys for lock number xyz



**873.3008-R008P**  
Full extension (with ball-bearing guide) with automatic retraction, right



**873.3008-R009P**  
Full extension (with ball-bearing guide) with automatic retraction, left



**873.5008-R009P**  
Fixed castors, incl. screws



**873.5008-R011P**  
Swivel castors with brakes, incl. screws

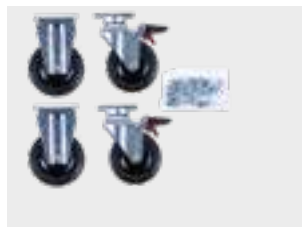

**873.5008-R014P**  
Roller set, incl. screws



**873.0008-R003P**  
Stainless steel work surface



**873.3008-R006P**  
Storage for work surface, including screw cover, usable on both sides



**873.1008-R004P**  
Compartment with website and ball-bearing guide, 568x398x65 mm



**873.1008-R003P**  
Compartment with ball-bearing guide, 568x398x65 mm



**873.0008-R002P**  
Compartment with logo and ball-bearing guide, 568x398x145 mm



**873.5008-R002P**  
Can holder, 310 mm



**873.3008-R002P**  
Paper roll holder, 320 mm



**873.4008-R005P**  
Plastic bumpers, front left, back right



**873.4008-R002P**  
Plastic bumpers, front right, back left



**873.7014-R004P**  
M8 screws (16 pcs.)



**873.7014-R003P**  
M6x12 screw (1 pcs.)



**873.0008-R001P**  
Body with handle



A thousand great parts for tough guys!

