

# P10

## Werkstattwagen

mit 284 Werkzeugen für 6 Schubladen

**810.6284**

## Werkstattwagen P10

mit 8 Schubladen

873.0008

# DAS EINSTIEGSMODELL FÜR HOHE ANSPRÜCHE



# P10



**DUO Lock** geniale Verschlusstechnik



**8 Schubladen** jeweils bis zu 50 kg belastbar



Stabiles **Kugellager**



**Edelstahloberfläche**



**Schloss** abschließbar



**Antistatische Rollen** mit Bremse



Integrierter **Kantenschutz**



Inklusive **Papierrollenhalter**



Inklusive **Dosenhalter**

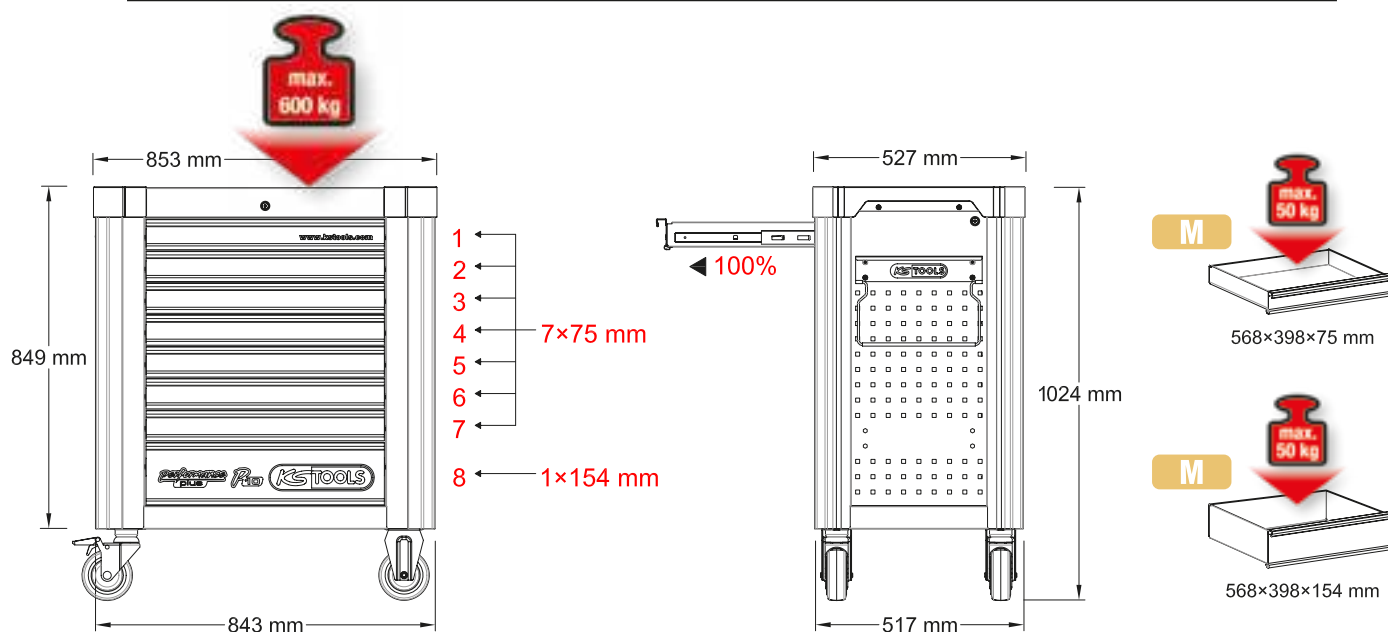

# P10 Werkstattwagen

mit 284 Werkzeugen für 6 Schubladen

810.6284



M



Schraubendreher-Satz

811.0027



1/4" + 1/2" Steckschlüssel-Satz

811.1137



Schraubenschlüssel-Satz

811.0046



Schraubenschlüssel-Satz

811.1024



Zangen- / und Feilen-Satz

811.0019



Hammer- / und Meißel-Satz

811.0022

811.0027

**M** Schraubendreher-Satz

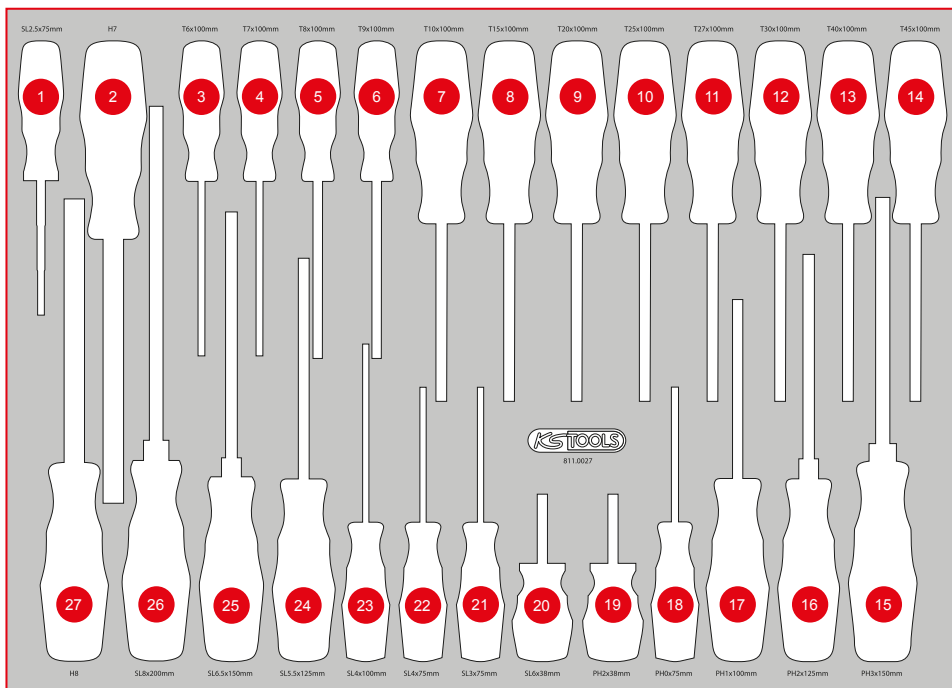
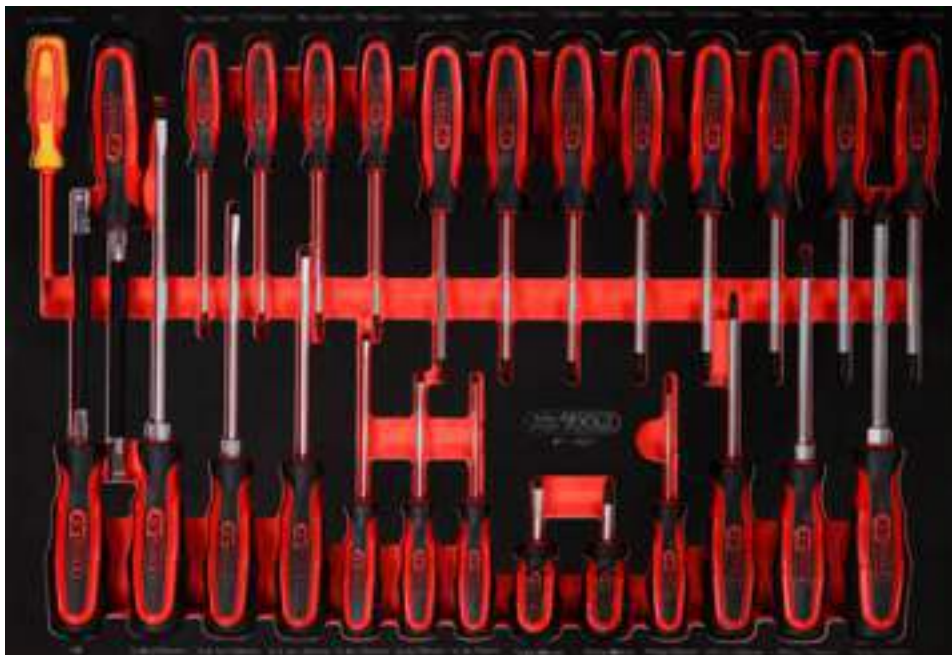

Pos.	Code	Bezeichnung	Teiligkeit
1	117.0502	ERGOTORQUE VDE Schlitz-Schraubendreher, 2,5 mm	1
2	159.1127	ERGOTORQUEplus Stecknuss-Schraubendreher, 7 mm	1
3	159.1134	ERGOTORQUEplus Schraubendreher, T6	1
4	159.1135	ERGOTORQUEplus Schraubendreher, T7	1
5	159.1030	ERGOTORQUEplus Schraubendreher, T8	1
6	159.1031	ERGOTORQUEplus Schraubendreher, T9	1
7	159.1032	ERGOTORQUEplus Schraubendreher, T10	1
8	159.1033	ERGOTORQUEplus Schraubendreher, T15	1
9	159.1034	ERGOTORQUEplus Schraubendreher, T20	1
10	159.1035	ERGOTORQUEplus Schraubendreher, T25	1
11	159.1036	ERGOTORQUEplus Schraubendreher, T27	1
12	159.1037	ERGOTORQUEplus Schraubendreher, T30	1
13	159.1038	ERGOTORQUEplus Schraubendreher, T40	1
14	159.1136	ERGOTORQUEplus Schraubendreher, T45	1
15	159.2128	ERGOTORQUEplus Stecknuss-Schraubendreher, 8 mm	1
16	159.1011	ERGOTORQUEplus Schlitz-Schraubendreher, 8 mm, 315 mm lang	1
17	159.1009	ERGOTORQUEplus Schlitz-Schraubendreher, 6,5 mm, 255 mm lang	1
18	159.1006	ERGOTORQUEplus Schlitz-Schraubendreher, 5,5 mm, 230 mm lang	1
19	159.1004	ERGOTORQUEplus Schlitz-Schraubendreher, 4 mm, 180 mm lang	1
20	159.1003	ERGOTORQUEplus Schlitz-Schraubendreher, 4 mm, 155 mm lang	1
21	159.1002	ERGOTORQUEplus Schlitz-Schraubendreher, 3 mm, 155 mm lang	1
22	159.1001	ERGOTORQUEplus Schlitz-Schraubendreher, kurz, 6 mm	1
23	159.1026	ERGOTORQUEplus Schraubendreher, kurz, PH2	1
24	159.1027	ERGOTORQUEplus Schraubendreher, PH0, 155 mm	1
25	159.1029	ERGOTORQUEplus Schraubendreher, PH1, 205 mm	1
26	159.1022	ERGOTORQUEplus Schraubendreher, PH2, 230 mm	1
27	159.1024	ERGOTORQUEplus Schraubendreher, PH3, 265 mm	1

# M 1/4" + 1/2" Steckschlüssel-Satz



Pos.	Code	Bezeichnung	Teilligkeit
1	911.1234	1/2" Vergrößerungsadapter, 1/2" F x 3/4" M	1
2	911.1341	1/2" Bit-Stecknuss XZN, M6, 55 mm	1
3	911.1342	1/2" Bit-Stecknuss XZN, M8, 55 mm	1
4	911.1343	1/2" Bit-Stecknuss XZN, M10, 55 mm	1
5	911.1365	1/2" Bit-Stecknuss Torx, T40	1
6	911.1366	1/2" Bit-Stecknuss Torx, T45	1
7	911.1367	1/2" Bit-Stecknuss Torx, T50	1
8	911.1368	1/2" Bit-Stecknuss Torx, T55	1
9	911.1369	1/2" Bit-Stecknuss Torx, T60	1
10	911.1305	1/2" Bit-Stecknuss Innensechskant, kurz, 5 mm	1
11	911.1306	1/2" Bit-Stecknuss Innensechskant, kurz, 6 mm	1
12	911.1307	1/2" Bit-Stecknuss Innensechskant, kurz, 7 mm	1
13	911.1308	1/2" Bit-Stecknuss Innensechskant, kurz, 8 mm	1
14	911.1310	1/2" Bit-Stecknuss Innensechskant, kurz, 10 mm	1
15	911.1312	1/2" Bit-Stecknuss Innensechskant, kurz, 12 mm	1
16	911.1314	1/2" Bit-Stecknuss Innensechskant, kurz, 14 mm	1
17	911.1317	1/2" Bit-Stecknuss Innensechskant, kurz, 17 mm	1
18	911.1319	1/2" Bit-Stecknuss Innensechskant, kurz, 19 mm	1
19	917.1217	1/2" Sechskant-Stecknuss, 17 mm	1

Pos.	Code	Bezeichnung	Teilligkeit
20	917.1218	1/2" Sechskant-Stecknuss, 18 mm	1
21	917.1219	1/2" Sechskant-Stecknuss, 19 mm	1
22	917.1220	1/2" Sechskant-Stecknuss, 20 mm	1
23	917.1221	1/2" Sechskant-Stecknuss, 21 mm	1
24	917.1222	1/2" Sechskant-Stecknuss, 22 mm	1
25	917.1223	1/2" Sechskant-Stecknuss, 23 mm	1
26	917.1224	1/2" Sechskant-Stecknuss, 24 mm	1
27	917.1342	1/2" Sechskant-Stecknuss, 25 mm	1
28	917.1343	1/2" Sechskant-Stecknuss, 26 mm	1
29	917.1227	1/2" Sechskant-Stecknuss, 27 mm	1
30	917.1344	1/2" Sechskant-Stecknuss, 28 mm	1
31	917.1230	1/2" Sechskant-Stecknuss, 30 mm	1
32	917.1232	1/2" Sechskant-Stecknuss, 32 mm	1
33	917.1216	1/2" Sechskant-Stecknuss, 16 mm	1
34	917.1215	1/2" Sechskant-Stecknuss, 15 mm	1
35	917.1214	1/2" Sechskant-Stecknuss, 14 mm	1
36	917.1213	1/2" Sechskant-Stecknuss, 13 mm	1
37	917.1212	1/2" Sechskant-Stecknuss, 12 mm	1
38	917.1211	1/2" Sechskant-Stecknuss, 11 mm	1
39	917.1210	1/2" Sechskant-Stecknuss, 10 mm	1
40	911.4334	1/2" Torx-E-Stecknuss, E11	1
41	911.4335	1/2" Torx-E-Stecknuss, E12	1
42	911.4336	1/2" Torx-E-Stecknuss, E14	1

Pos.	Code	Bezeichnung	Teilligkeit
43	911.4322	1/2" Torx-E-Stecknuss, E16	1
44	911.4323	1/2" Torx-E-Stecknuss, E18	1
45	911.4324	1/2" Torx-E-Stecknuss, E20	1
46	911.4326	1/2" Torx-E-Stecknuss, E24	1
47	911.1436	1/4" Bit-Stecknuss Innensechskant, 3 mm	1
48	911.1437	1/4" Bit-Stecknuss Innensechskant, 4 mm	1
49	911.1438	1/4" Bit-Stecknuss Innensechskant, 5 mm	1
50	911.1439	1/4" Bit-Stecknuss Innensechskant, 6 mm	1
51	911.1440	1/4" Bit-Stecknuss Innensechskant, 7 mm	1
52	911.1441	1/4" Bit-Stecknuss Innensechskant, 8 mm	1
53	911.4407	1/4" Bit-Stecknuss Torx, T6	1
54	911.4362	1/4" Bit-Stecknuss Torx, T7	1
55	911.1448	1/4" Bit-Stecknuss Torx, T8	1
56	911.1478	1/4" Bit-Stecknuss Torx, T9	1
57	911.1442	1/4" Bit-Stecknuss Torx, T10	1
58	911.1443	1/4" Bit-Stecknuss Torx, T15	1
59	911.1444	1/4" Bit-Stecknuss Torx, T20	1
60	911.1445	1/4" Bit-Stecknuss Torx, T25	1
61	911.1449	1/4" Bit-Stecknuss Torx, T27	1
62	911.1446	1/4" Bit-Stecknuss Torx, T30	1
63	911.1447	1/4" Bit-Stecknuss Torx, T40	1
64	911.1415	1/4" Bit-Stecknuss, PH1	1
65	911.1416	1/4" Bit-Stecknuss, PH2	1



# M Schraubenschlüssel-Satz



TLG  
46

568 x 398



Pos.	Code	Bezeichnung	Teilligkeit
1	517.0606	Ringmaulschlüssel, abgewinkelt, 6 mm	1
2	517.0607	Ringmaulschlüssel, abgewinkelt, 7 mm	1
3	517.0608	Ringmaulschlüssel, abgewinkelt, 8 mm	1
4	517.0609	Ringmaulschlüssel, abgewinkelt, 9 mm	1
5	517.0610	Ringmaulschlüssel, abgewinkelt, 10 mm	1
6	517.0611	Ringmaulschlüssel, abgewinkelt, 11 mm	1
7	517.0612	Ringmaulschlüssel, abgewinkelt, 12 mm	1
8	517.0613	Ringmaulschlüssel, abgewinkelt, 13 mm	1
9	517.0614	Ringmaulschlüssel, abgewinkelt, 14 mm	1

Pos.	Code	Bezeichnung	Teilligkeit
10	517.0615	Ringmaulschlüssel, abgewinkelt, 15 mm	1
11	517.0616	Ringmaulschlüssel, abgewinkelt, 16 mm	1
12	517.0617	Ringmaulschlüssel, abgewinkelt, 17 mm	1
13	517.0618	Ringmaulschlüssel, abgewinkelt, 18 mm	1
14	517.0619	Ringmaulschlüssel, abgewinkelt, 19 mm	1
15	517.0621	Ringmaulschlüssel, abgewinkelt, 21 mm	1
16	517.0622	Ringmaulschlüssel, abgewinkelt, 22 mm	1
17	517.0624	Ringmaulschlüssel, abgewinkelt, 24 mm	1
18	517.0627	Ringmaulschlüssel, abgewinkelt, 27 mm	1

Pos.	Code	Bezeichnung	Teilligkeit
19	911.0371	Torx-E-Doppel-Ringschlüssel, E6 x E8	1
20	911.0373	Torx-E-Doppel-Ringschlüssel, E10 x E12	1
21	911.0374	Torx-E-Doppel-Ringschlüssel, E14 x E18	1
22	911.0376	Torx-E-Doppel-Ringschlüssel, E20 x E24	1
23	920.0406	ULTIMATEplus Doppel-Ringschlüssel, 6 x 7 mm	1
24	920.0408	ULTIMATEplus Doppel-Ringschlüssel, 8 x 9 mm	1
25	920.0410	ULTIMATEplus Doppel-Ringschlüssel, 10 x 11 mm	1
26	920.0412	ULTIMATEplus Doppel-Ringschlüssel, 12 x 13 mm	1

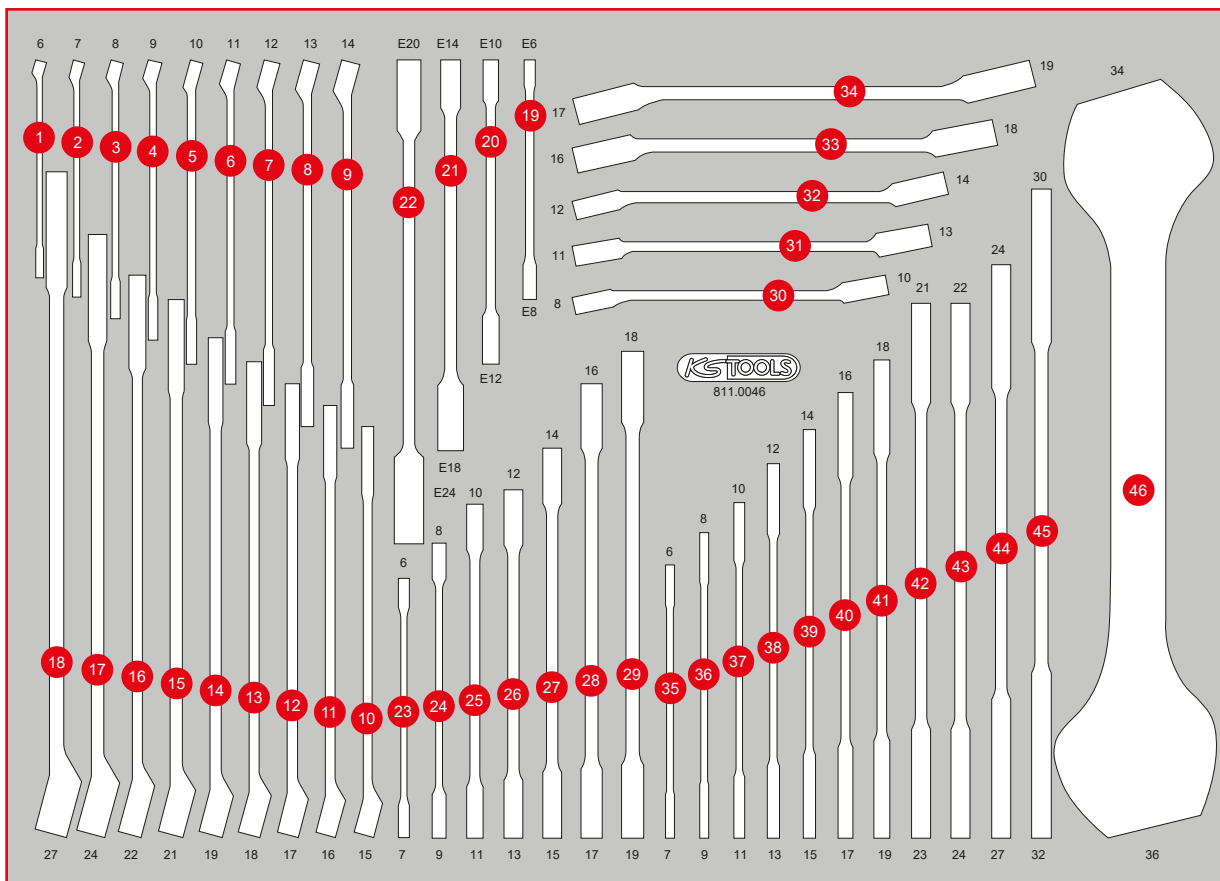

Pos.	Code	Bezeichnung	Teilligkeit	Pos.	Code	Bezeichnung	Teilligkeit	Pos.	Code	Bezeichnung	Teilligkeit
27	920.0414	ULTIMATEplus Doppel-Ringschlüssel, 14 x 15 mm	1	32	517.0258	Offener Doppel-Ringschlüssel, abgewinkelt, 12 x 14 mm	1	39	517.0709	Doppel-Maulschlüssel, 14 x 15 mm	1
28	920.0416	ULTIMATEplus Doppel-Ringschlüssel, 16 x 17 mm	1	33	517.0263	Offener Doppel-Ringschlüssel, abgewinkelt, 16 x 18 mm	1	40	517.0710	Doppel-Maulschlüssel, 16 x 17 mm	1
29	920.0418	ULTIMATEplus Doppel-Ringschlüssel, 18 x 19 mm	1	34	517.0264	Offener Doppel-Ringschlüssel, abgewinkelt, 17 x 19 mm	1	41	517.0712	Doppel-Maulschlüssel, 18 x 19 mm	1
30	517.0252	Offener Doppel-Ringschlüssel, abgewinkelt, 8 x 10 mm	1	35	517.0701	Doppel-Maulschlüssel, 6 x 7 mm	1	42	517.0715	Doppel-Maulschlüssel, 21 x 23 mm	1
31	517.9244	Offener Doppel-Ringschlüssel, abgewinkelt, 11 x 13 mm	1	36	517.0702	Doppel-Maulschlüssel, 8 x 9 mm	1	43	517.0736	Doppel-Maulschlüssel, 22 x 24 mm	1
				37	517.0704	Doppel-Maulschlüssel, 10 x 11 mm	1	44	517.0716	Doppel-Maulschlüssel, 24 x 27 mm	1
				38	517.0707	Doppel-Maulschlüssel, 12 x 13 mm	1	45	517.0718	Doppel-Maulschlüssel, 30 x 32 mm	1
								46	517.0773	Doppel-Maulschlüssel, 34 x 36 mm	1

# M Schraubenschlüssel-Satz



568 x 398

P10

P10TC

P15

P20

P30

P35

P45

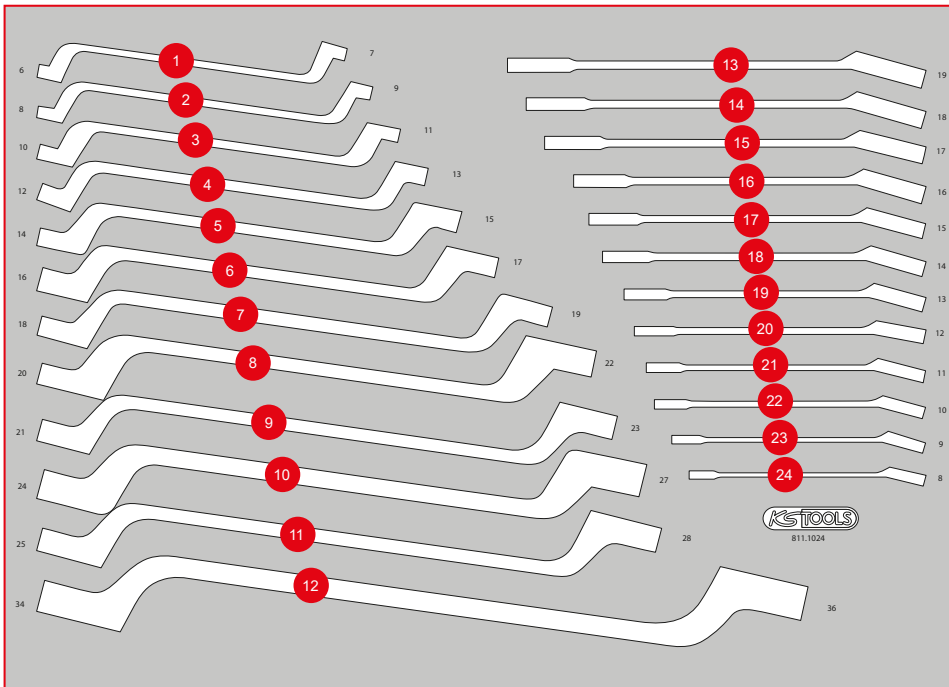

Pos.	Code	Bezeichnung	Teiligkeit
1	517.0801	Doppel-Ringschlüssel, gekröpft, 6 x 7 mm	1
2	517.0802	Doppel-Ringschlüssel, gekröpft, 8 x 9 mm	1
3	517.0804	Doppel-Ringschlüssel, gekröpft, 10 x 11 mm	1
4	517.0807	Doppel-Ringschlüssel, gekröpft, 12 x 13 mm	1
5	517.0809	Doppel-Ringschlüssel, gekröpft, 14 x 15 mm	1
6	517.0810	Doppel-Ringschlüssel, gekröpft, 16 x 17 mm	1
7	517.0812	Doppel-Ringschlüssel, gekröpft, 18 x 19 mm	1
8	517.0813	Doppel-Ringschlüssel, gekröpft, 20 x 22 mm	1
9	517.0815	Doppel-Ringschlüssel, gekröpft, 21 x 23 mm	1
10	517.0816	Doppel-Ringschlüssel, gekröpft, 24 x 27 mm	1
11	517.0857	Doppel-Ringschlüssel, gekröpft, 25 x 28 mm	1
12	517.0818	Doppel-Ringschlüssel, gekröpft, 30 x 32 mm	1
13	503.4619	GEARplus Ratschenringmaulschlüssel, umschaltbar, 19 mm	1
14	503.4618	GEARplus Ratschenringmaulschlüssel, umschaltbar, 18 mm	1
15	503.4617	GEARplus Ratschenringmaulschlüssel, umschaltbar, 17 mm	1
16	503.4616	GEARplus Ratschenringmaulschlüssel, umschaltbar, 16 mm	1
17	503.4615	GEARplus Ratschenringmaulschlüssel, umschaltbar, 15 mm	1
18	503.4614	GEARplus Ratschenringmaulschlüssel, umschaltbar, 14 mm	1
19	503.4613	GEARplus Ratschenringmaulschlüssel, umschaltbar, 13 mm	1
20	503.4612	GEARplus Ratschenringmaulschlüssel, umschaltbar, 12 mm	1
21	503.4611	GEARplus Ratschenringmaulschlüssel, umschaltbar, 11 mm	1
22	503.4610	GEARplus Ratschenringmaulschlüssel, umschaltbar, 10 mm	1
23	503.4609	GEARplus Ratschenringmaulschlüssel, umschaltbar, 9 mm	1
24	503.4608	GEARplus Ratschenringmaulschlüssel, umschaltbar, 8 mm	1

811.0019

**M** Zangen- / und Feilen-Satz



Pos.	Code	Bezeichnung	Teiligkeit
1	157.0405	Dreikant-Feile, Form C, 200 mm, Hieb 2	1
2	157.0105	Halbrund-Feile, Form E, 200 mm, Hieb 2	1
3	157.0005	Flachfeile, Form B, 200 mm, Hieb 2	1
4	157.0205	Rund-Feile, Form F, 200 mm, Hieb 2	1
5	907.2166	Abbrechklingen 0,5 x 18 x 100 mm, Spender à 10 Stück	10
6	300.0114	Bandmaß mit Feststeller, schwarz-rot, 5 m, 19 mm	1
7	300.0510	Taschen-Messschieber 0-150 mm, 235 mm	1
8	300.0600	Fühlerlehre, 20 Blatt, 0,05-1 mm	1
9	907.2135	Universal-Abbrechklingen-Messer 18 mm	1
10	115.1033	Gripzange, 60 mm, 220 mm	1
11	115.2010	Wasserpumpenzange mit Druckknopfverstellung, 240 mm	1
12	500.1026	Außen-Sicherungszange, abgewinkelt, 160 mm	1
13	500.1029	Sicherungszange für Außensicherungsringe, 160 mm	1
14	500.1032	Innen-Sicherungszange, abgewinkelt, 160 mm	1
15	500.1035	Sicherungszange für Innensicherungsringe, 160 mm	1
16	115.1012	ERGOTORQUE Diagonal-Seitenschneider, 160 mm	1
17	115.1021	ERGOTORQUE Kombinationszange, 180 mm	1
18	115.1019	ERGOTORQUE Flachrundzange, gebogen, 210 mm	1
19	115.1024	ERGOTORQUE Telefonzange, 200 mm	1

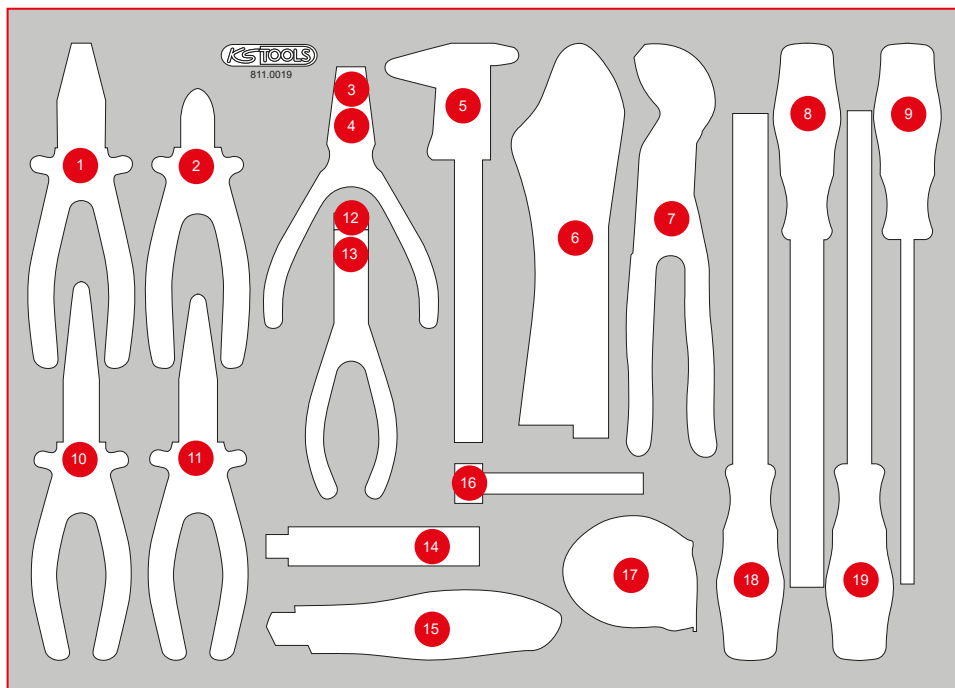

**M** Hammer- / und Meißel-Satz



Pos.	Code	Bezeichnung	Teiligkeit
1	911.8138	Zierleisten-Kunststoffkeil, 195 mm x B = 30 mm	1
2	140.5252	Rückschlagfreier Schonhammer, 400 g	1
3	142.1402	Schlosser Hammer mit Fiberglasstiel, 400 g	1
4	142.5101	Fäustel mit Fiberglasstiel, 1000 g	1
5	550.1025	Flexibler Magnethalter, 510 mm, Ø Kopf = 15 mm	1
6	550.1001	2 in 1 Teleskop-Magnethalter mit Waschlinsen-Reinigungs- und Einstellwerkzeug, 150 - 675 mm	1
7	150.4370	perfectLight Taschenlampe 85 Lumen	1
8	911.8146	Reifen-Montierhebel, 370 mm	1
9	201.2335	Bremssattel-Drahtbürste 2-reihig, gerade, 225 mm	1
10	156.0241	Flachmeißel mit Handschutzgriff, 8-kant, 20 mm	1
11	156.0254	Flachmeißel mit Handschutzgriff, 8-kant, 18 mm	1
12	156.0242	Kreuzmeißel, 7 mm, 8-kant	1
13	156.0243	Körner, 10 mm, 8-kant	1
14	156.0244	Durchtreiber, Ø 5 mm, konisch	1
15	156.0238	Durchtreiber mit Handschutzgriff, 8-kant, konisch, 4 mm	1
16	156.0237	Durchtreiber mit Handschutzgriff, 8-kant, konisch, 3 mm	1
17	156.0231	Durchtreiber, Ø 3 mm, zylindrisch	1
18	156.0232	Splintentreiber, Ø 4 mm, zylindrisch	1
19	156.0233	Durchtreiber, Ø 5 mm, zylindrisch	1
20	156.0234	Durchtreiber, Ø 6 mm, zylindrisch	1
21	156.0235	Durchtreiber, Ø 8 mm, zylindrisch	1
22	907.2232	Dichtungsschaber, 25 x 200 mm	1

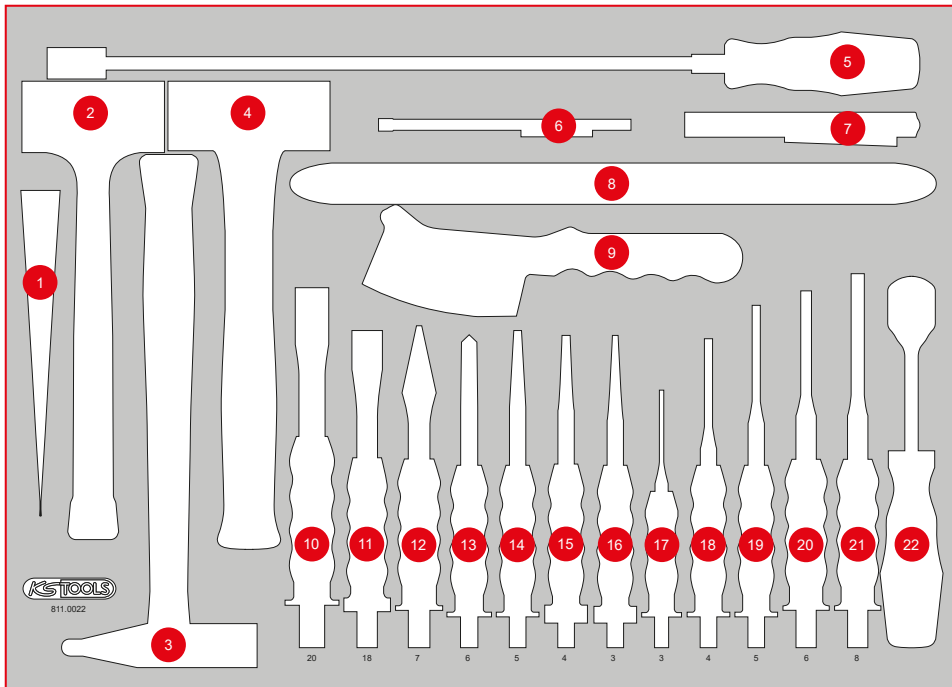





**873.7014-R101P...R200P**  
Ersatzschlüssel für Schlossnum-  
mer xyz



**873.7014-R201P...R300P**  
Schloss inklusive 2 Schlüssel,  
Schlossnummer xyz



**873.3008-R008P**  
Laufschiene mit Selbsteinzug,  
für Schublade, rechts



**873.3008-R009P**  
Laufschiene mit Selbsteinzug,  
für Schublade, links



**873.5008-R009P**  
Laufrolle, starr, inklusive  
Schrauben



**873.5008-R011P**  
Lenkrolle mit Feststellbremse  
inklusive Schrauben

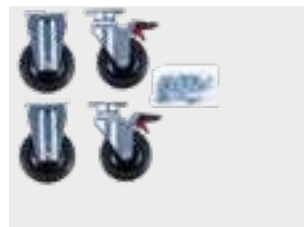

**873.5008-R014P**  
Rollensatz, 2 x Lenkrolle + 2 x  
Laufrolle, inklusive Schrauben



**873.0008-R003P**  
Edelstahl-Arbeitsplatte



**873.3008-R006P**  
Ablagefach inklusive Schrauben-  
abdeckung, beidseitig verwendbar



**873.1008-R004P**  
Schublade mit Website, inklusive  
Laufschiene, H=65 mm, B=568  
mm x T=398 mm



**873.1008-R003P**  
Schublade, inklusive Laufschiene,  
H=65 mm, B=568 mm x T=398 mm



**873.0008-R002P**  
Schublade mit Logo, inkl. Lauf-  
schiene, H=145 mm, B=568 mm  
x T=398 mm



**873.5008-R002P**  
Dosenhalter inklusive Schrauben,  
B = 310 mm



**873.3008-R002P**  
Papierrollenhalter inklusive  
Schrauben, B = 320 mm



**873.4008-R005P**  
Kunststoff-Stoßfänger für vorne links  
und hinten rechts



**873.4008-R002P**  
Kunststoff-Stoßfänger für vorne  
rechts und hinten links



**873.7014-R004P**  
Schraube, M8, mit Unterlegscheibe,  
16 Stück



**873.7014-R003P**  
Schraube, M6 x 12 mm, 1 Stück



**873.0008-R001P**  
Stahlkorpus mit Griff



Tausend tolle Teile  
für thoughe Typen!