

# P10

**workshop tool trolley**  
with 284 tools for 6 drawers  
**810.6284**

---

**Workshop trolley P10**

with 8 compartments

873.0008

# THE ENTRY MODEL TO SATISFY HIGH STANDARDS



P10



**DUO Lock** Brilliant locking system



**Eight drawers** each load capacity up to 50 kg



Stable **ball bearing**



**Stainless steel surface**



**Lock** lockable



**Anti-static castors** with brakes



Integrated **corner protection**



**Paper roll holder** included



**Can holder** included

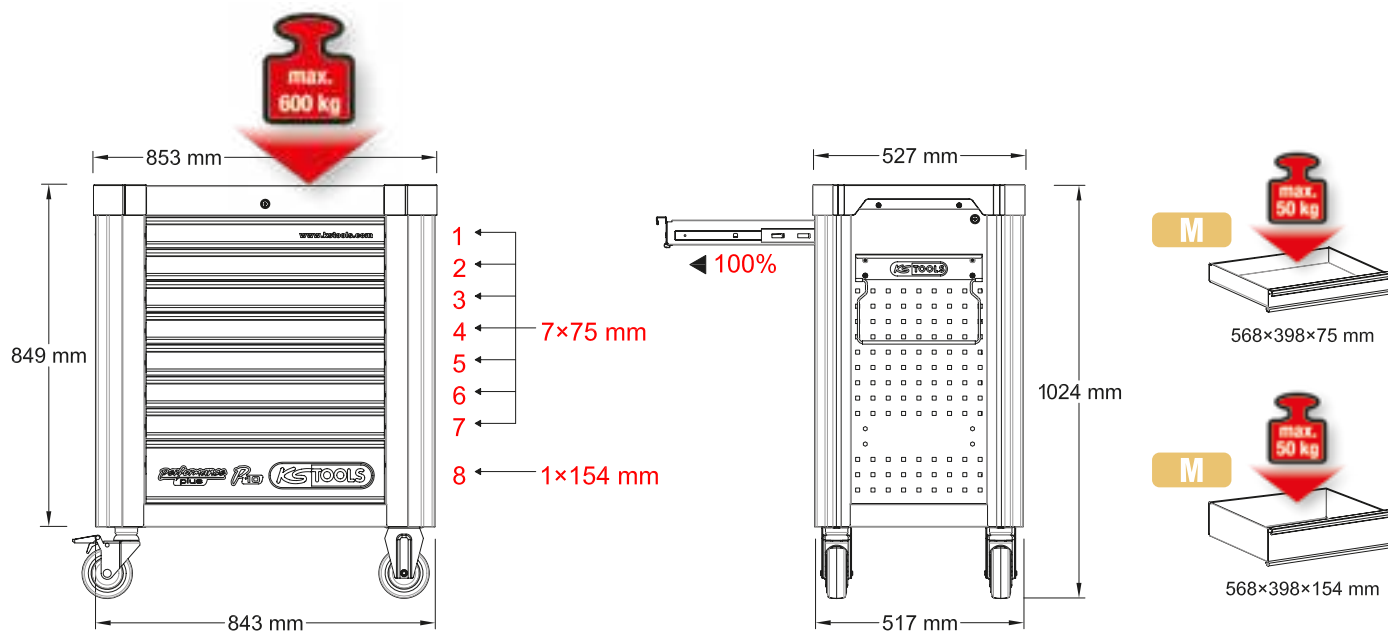

# P10 workshop tool trolley set with 284 tools for 6 drawers

810.6284



M

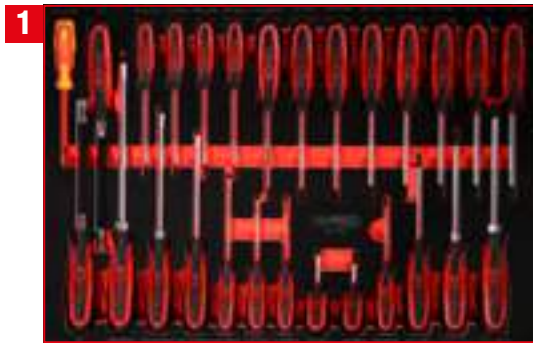

1



Screwdriver set in foam insert

811.0027

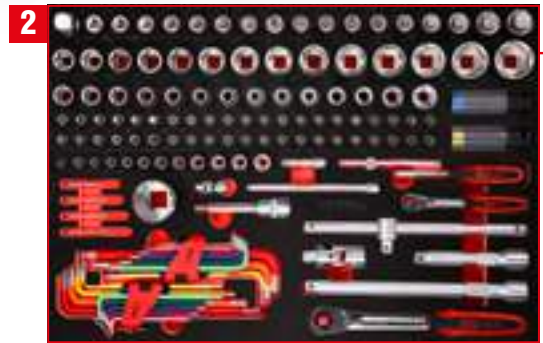

2



1/4" + 1/2" socket spanner set in foam insert

811.1137



3



Screw spanner set in foam insert

811.0046



4



Screw spanner set in foam insert

811.1024



5



Pliers and file set in foam insert

811.0019



6



Hammer and chisel set in foam insert

811.0022

811.0027

**M** Screwdriver set

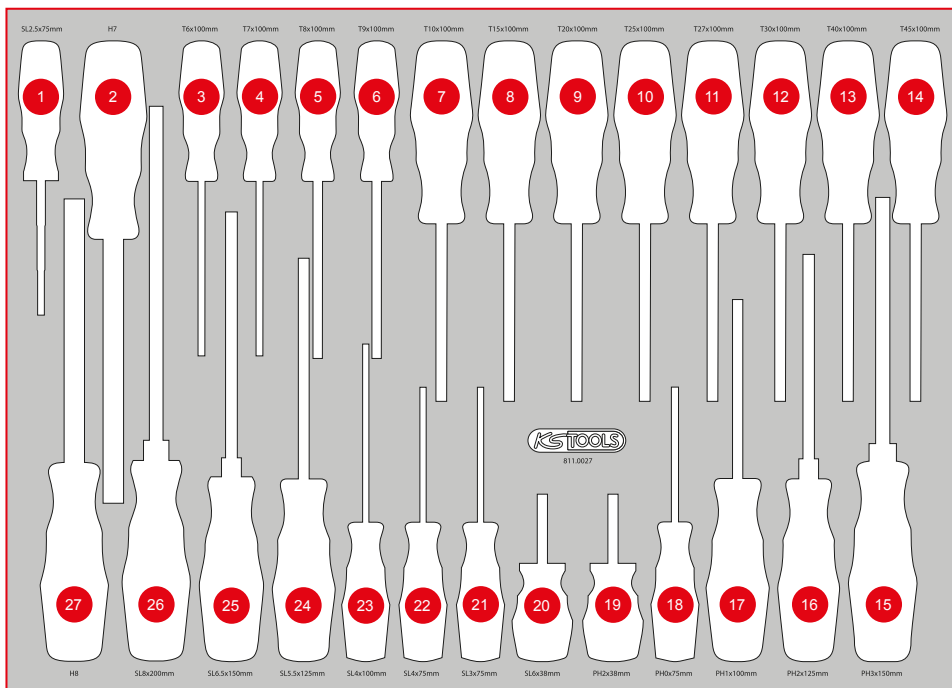
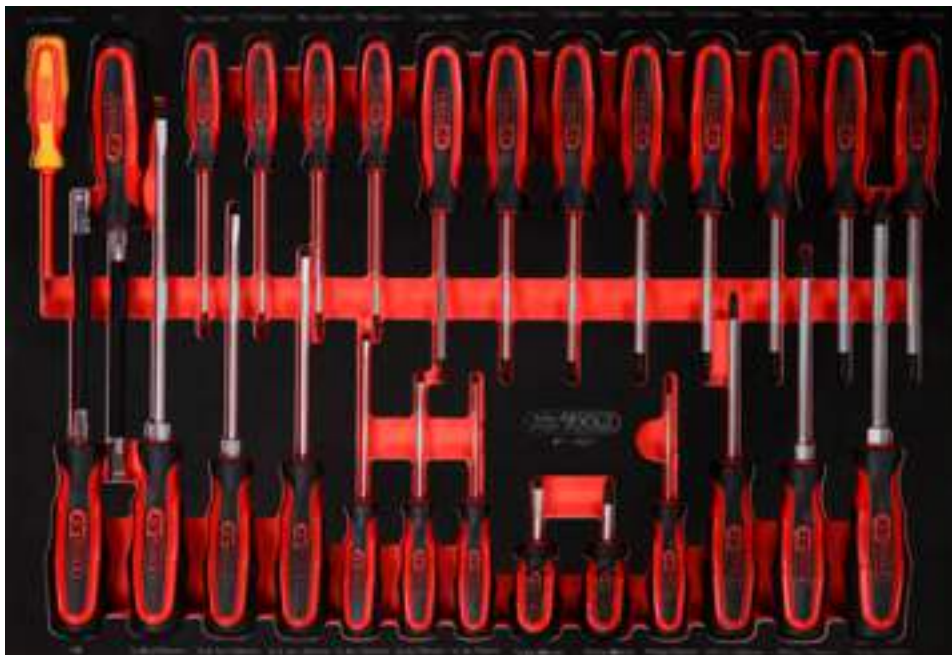

Pos.	Code	Description	pcs
1	117.0502	ERGOTORQUE VDE slot screwdriver, 2,5 mm	1
2	159.1127	ERGOTORQUEplus Socket screwdriver, 7 mm	1
3	159.1134	ERGOTORQUEplus screwdriver, Torx, T6	1
4	159.1135	ERGOTORQUEplus screwdriver, Torx, T7	1
5	159.1030	ERGOTORQUEplus screwdriver, Torx, T8	1
6	159.1031	ERGOTORQUEplus screwdriver, Torx, T9	1
7	159.1032	ERGOTORQUEplus screwdriver, Torx, T10	1
8	159.1033	ERGOTORQUEplus screwdriver, Torx, T15	1
9	159.1034	ERGOTORQUEplus screwdriver, Torx, T20	1
10	159.1035	ERGOTORQUEplus screwdriver, Torx, T25	1
11	159.1036	ERGOTORQUEplus screwdriver, Torx, T27	1
12	159.1037	ERGOTORQUEplus screwdriver, Torx, T30	1
13	159.1038	ERGOTORQUEplus screwdriver, Torx, T40	1
14	159.1136	ERGOTORQUEplus screwdriver, Torx, T45	1
15	159.2128	ERGOTORQUEplus Socket screwdriver, 8 mm	1
16	159.1011	ERGOTORQUEplus screwdriver for slotted screws, 8 mm, 315 mm	1
17	159.1009	ERGOTORQUEplus screwdriver for slotted screws, 6,5 mm, 255 mm	1
18	159.1006	ERGOTORQUEplus screwdriver for slotted screws, 5,5 mm, 230 mm	1
19	159.1004	ERGOTORQUEplus screwdriver for slotted screws, 4 mm, 180 mm	1
20	159.1003	ERGOTORQUEplus screwdriver for slotted screws, 4 mm, 155 mm	1
21	159.1002	ERGOTORQUEplus screwdriver for slotted screws, 3 mm, 155 mm	1
22	159.1001	ERGOTORQUEplus screwdriver for slotted screws, 6 mm, stubby	1
23	159.1026	ERGOTORQUEplus screwdriver for screws PH, PH2, stubby	1
24	159.1027	ERGOTORQUEplus screwdriver for screws PH, PH0, 155 mm	1
25	159.1029	ERGOTORQUEplus screwdriver for screws PH, PH1, 205 mm	1
26	159.1022	ERGOTORQUEplus screwdriver for screws PH, PH2, 230 mm	1
27	159.1024	ERGOTORQUEplus screwdriver for screws PH, PH3, 265 mm	1

811.1137

**M** 1/4" + 1/2" socket spanner set



Pos.	Code	Description	pcs	Pos.	Code	Description	pcs	Pos.	Code	Description	pcs
1	911.1234	Adaptor, 1/2" F x 3/4" M	1	22	917.1220	1/2" Hexagonal socket, 20 mm	1	43	911.4322	1/2" Torx E Socket, E16	1
2	911.1341	1/2" Bit socket spline (XZN), M6, 55 mm	1	23	917.1221	1/2" Hexagonal socket, 21 mm	1	44	911.4323	1/2" Torx E Socket, E18	1
3	911.1342	1/2" Bit socket spline (XZN), M8, 55 mm	1	24	917.1222	1/2" Hexagonal socket, 22 mm	1	45	911.4324	1/2" Torx E Socket, E20	1
4	911.1343	1/2" Bit socket spline (XZN), M10, 55 mm	1	25	917.1223	1/2" Hexagonal socket, 23 mm	1	46	911.4326	1/2" Torx E Socket, E24	1
5	911.1365	1/2" Bit socket Torx, T40	1	26	917.1224	1/2" Hexagonal socket, 24 mm	1	47	911.1436	1/4" Bit socket hexagon, 3 mm	1
6	911.1366	1/2" Bit socket Torx, T45	1	27	917.1342	1/2" Hexagonal socket, 25 mm	1	48	911.1437	1/4" Bit socket hexagon, 4 mm	1
7	911.1367	1/2" Bit socket Torx, T50	1	28	917.1343	1/2" Hexagonal socket, 26 mm	1	49	911.1438	1/4" Bit socket hexagon, 5 mm	1
8	911.1368	1/2" Bit socket Torx, T55	1	29	917.1227	1/2" Hexagonal socket, 27 mm	1	50	911.1439	1/4" Bit socket hexagon, 6 mm	1
9	911.1369	1/2" Bit socket Torx, T60	1	30	917.1344	1/2" Hexagonal socket, 28 mm	1	51	911.1440	1/4" Bit socket hexagon, 7 mm	1
10	911.1305	1/2" Bit socket hexagon, short, 5 mm	1	31	917.1230	1/2" Hexagonal socket, 30 mm	1	52	911.1441	1/4" Bit socket hexagon, 8 mm	1
11	911.1306	1/2" Bit socket hexagon, short, 6 mm	1	32	917.1232	1/2" Hexagonal socket, 32 mm	1	53	911.4407	1/4" Bit socket Torx, T6	1
12	911.1307	1/2" Bit socket hexagon, short, 7 mm	1	33	917.1216	1/2" Hexagonal socket, 16 mm	1	54	911.4362	1/4" Bit socket Torx, T7	1
13	911.1308	1/2" Bit socket hexagon, short, 8 mm	1	34	917.1215	1/2" Hexagonal socket, 15 mm	1	55	911.1448	1/4" Bit socket Torx, T8	1
14	911.1310	1/2" Bit socket hexagon, short, 10 mm	1	35	917.1214	1/2" Hexagonal socket, 14 mm	1	56	911.1478	1/4" Bit socket Torx, T9	1
15	911.1312	1/2" Bit socket hexagon, short, 12 mm	1	36	917.1213	1/2" Hexagonal socket, 13 mm	1	57	911.1442	1/4" Bit socket Torx, T10	1
16	911.1314	1/2" Bit socket hexagon, short, 14 mm	1	37	917.1212	1/2" Hexagonal socket, 12 mm	1	58	911.1443	1/4" Bit socket Torx, T15	1
17	911.1317	1/2" Bit socket hexagon, short, 17 mm	1	38	917.1211	1/2" Hexagonal socket, 11 mm	1	59	911.1444	1/4" Bit socket Torx, T20	1
18	911.1319	1/2" Bit socket hexagon, short, 19 mm	1	39	917.1210	1/2" Hexagonal socket, 10 mm	1	60	911.1445	1/4" Bit socket Torx, T25	1
19	917.1217	1/2" Hexagonal socket, 17 mm	1	40	911.4334	1/2" Torx E Socket, E11	1	61	911.1449	1/4" Bit socket Torx, T27	1
20	917.1218	1/2" Hexagonal socket, 18 mm	1	41	911.4335	1/2" Torx E Socket, E12	1	62	911.1446	1/4" Bit socket Torx, T30	1
21	917.1219	1/2" Hexagonal socket, 19 mm	1	42	911.4336	1/2" Torx E Socket, E14	1	63	911.1447	1/4" Bit socket Torx, T40	1

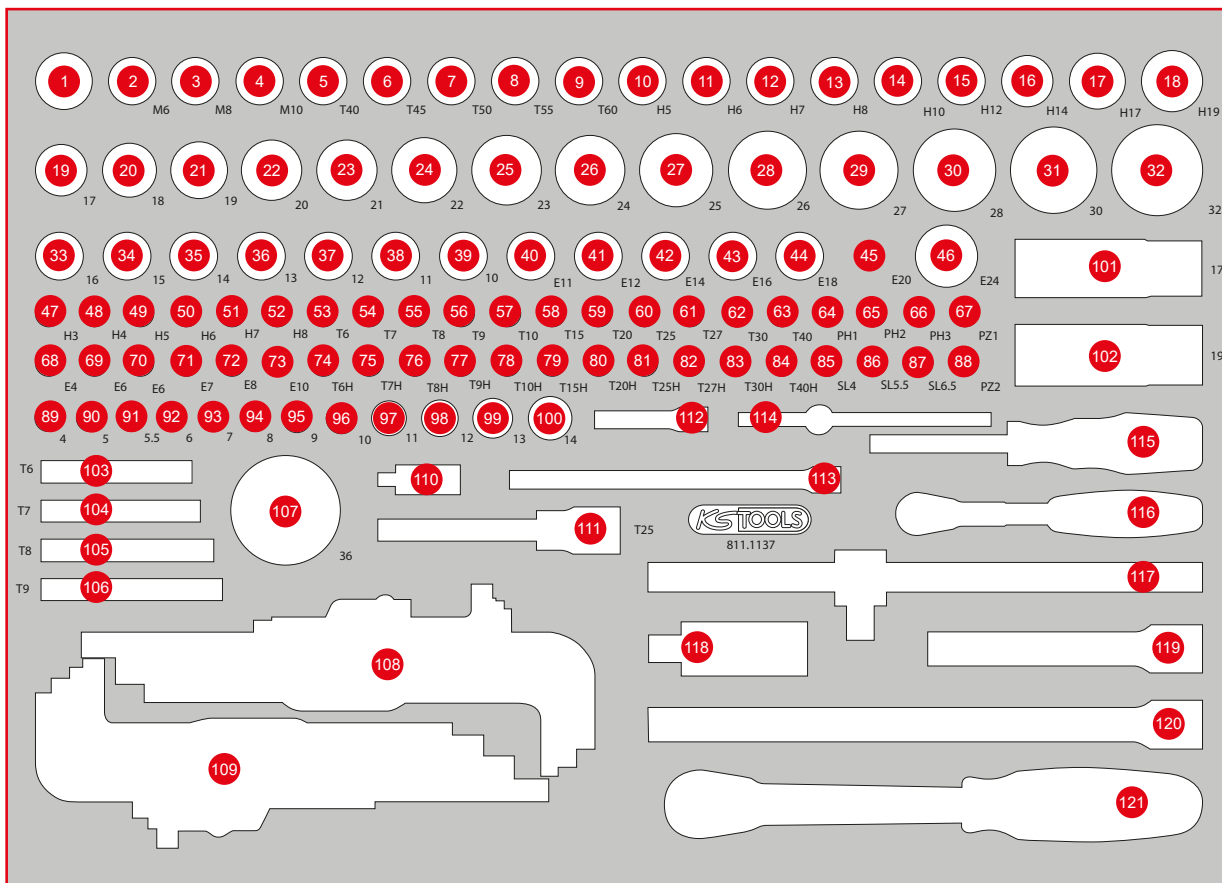

Pos.	Code	Description	pcs	Pos.	Code	Description	pcs	Pos.	Code	Description	pcs
64	911.1415	1/4" Bit socket, PH1	1	85	911.1418	1/4" Bit socket slot, 4 mm	1	106	151.2344	Torx key wrench, short, T9	1
65	911.1416	1/4" Bit socket, PH2	1	86	911.1419	1/4" Bit socket slot, 5,5 mm	1	107	911.3548	3/4" 12 Point socket, short, 36 mm	1
66	911.1417	1/4" Bit socket, PH3	1	87	917.1421	1/4" Bit socket slot, 6,5 mm	1	108	151.4530	Ball ended Torx key wrench set, extra long and bent 108°, 9 pcs	9
67	911.1401	1/4" Bit socket, PZ1	1	88	911.1402	1/4" Bit socket, PZ2	1	109	151.4420	Ball ended hexagon key wrench set, extra long, 9 pcs	9
68	911.4313	1/4" Torx E Socket, E4	1	89	917.1404	1/4" Hexagonal socket, 4 mm	1	110	911.1450	1/4" Universal joint	1
69	911.4314	1/4" Torx E Socket, E5	1	90	917.1405	1/4" Hexagonal socket, 5 mm	1	111	918.1643	1/2" CHROMEplus Bit socket Torx, long, T25	1
70	911.4315	1/4" Torx E Socket, E6	1	91	917.14055	1/4" Hexagonal socket, 5,5 mm	1	112	911.1423	1/4" Extension with hexagon drive, 50 mm	1
71	911.4316	1/4" Torx E Socket, E7	1	92	917.1406	1/4" Hexagonal socket, 6 mm	1	113	911.1451	1/4" Extension with hexagon drive, 150 mm	1
72	911.4317	1/4" Torx E Socket, E8	1	93	917.1407	1/4" Hexagonal socket, 7 mm	1	114	911.1425	Sliding T-bar, 1/4", 110 mm	1
73	911.4332	1/4" Torx E Socket, E10	1	94	917.1408	1/4" Hexagonal socket, 8 mm	1	115	911.1434	1/4" Square drive screwdriver, 150 mm	1
74	917.1456	1/4" Bit socket Torx tamperproof, TB6	1	95	917.1409	1/4" Hexagonal socket, 9 mm	1	116	920.1490	1/4" SlimPOWER Reversible ratchet, 72 teeth	1
75	917.1457	1/4" Bit socket Torx tamperproof, TB7	1	96	917.1410	1/4" Hexagonal socket, 10 mm	1	117	911.1204	Sliding T-bar, 1/2", 250 mm	1
76	911.1461	1/4" Bit socket Torx tamperproof, TB8	1	97	917.1411	1/4" Hexagonal socket, 11 mm	1	118	911.1250	1/2" Universal joint	1
77	911.1485	1/4" Bit socket Torx tamperproof, TB9	1	98	917.1412	1/4" Hexagonal socket, 12 mm	1	119	911.1202	1/2" Extensions, 125 mm	1
78	911.1462	1/4" Bit socket Torx tamperproof, TB10	1	99	917.1413	1/4" Hexagonal socket, 13 mm	1	120	911.1203	1/2" Extensions, 250 mm	1
79	911.1463	1/4" Bit socket Torx tamperproof, TB15	1	100	917.1414	1/4" Hexagonal socket, 14 mm	1	121	920.1290	1/2" SlimPOWER Reversible ratchet, 72 teeth	1
80	911.1464	1/4" Bit socket Torx tamperproof, TB20	1	101	515.0992	SlimPOWER 1/2" Alloy rim impact socket, 17 mm	1				
81	911.1465	1/4" Bit socket Torx tamperproof, TB25	1	102	515.0993	SlimPOWER 1/2" Alloy rim impact socket, 19 mm	1				
82	911.1466	1/4" Bit socket Torx tamperproof, TB27	1	103	151.2341	Torx key wrench, short, T6	1				
83	911.1467	1/4" Bit socket Torx tamperproof, TB30	1	104	151.2342	Torx key wrench, short, T7	1				
84	911.1468	1/4" Bit socket Torx tamperproof, TB40	1	105	151.2343	Torx key wrench, short, T8	1				

811.0046

**M** Screw spanner set



Pos.	Code	Description	pcs	Pos.	Code	Description	pcs	Pos.	Code	Description	pcs
1	517.0606	Combination spanners, offset, 6 mm	1	10	517.0615	Combination spanners, offset, 15 mm	1	19	911.0371	Double ring spanner for Torx E profile, E6 x E8	1
2	517.0607	Combination spanners, offset, 7 mm	1	11	517.0616	Combination spanners, offset, 16 mm	1	20	911.0373	Double ring spanner for Torx E profile, E10 x E12	1
3	517.0608	Combination spanners, offset, 8 mm	1	12	517.0617	Combination spanners, offset, 17 mm	1	21	911.0374	Double ring spanner for Torx E profile, E14 x E18	1
4	517.0609	Combination spanners, offset, 9 mm	1	13	517.0618	Combination spanners, offset, 18 mm	1	22	911.0376	Double ring spanner for Torx E profile, E20 x E24	1
5	517.0610	Combination spanners, offset, 10 mm	1	14	517.0619	Combination spanners, offset, 19 mm	1	23	920.0406	ULTIMATEplus Double ring ended spanner, 6 x 7 mm	1
6	517.0611	Combination spanners, offset, 11 mm	1	15	517.0621	Combination spanners, offset, 21 mm	1	24	920.0408	ULTIMATEplus Double ring ended spanner, 8 x 9 mm	1
7	517.0612	Combination spanners, offset, 12 mm	1	16	517.0622	Combination spanners, offset, 22 mm	1				
8	517.0613	Combination spanners, offset, 13 mm	1	17	517.0624	Combination spanners, offset, 24 mm	1				
9	517.0614	Combination spanners, offset, 14 mm	1	18	517.0627	Combination spanners, offset, 27 mm	1				

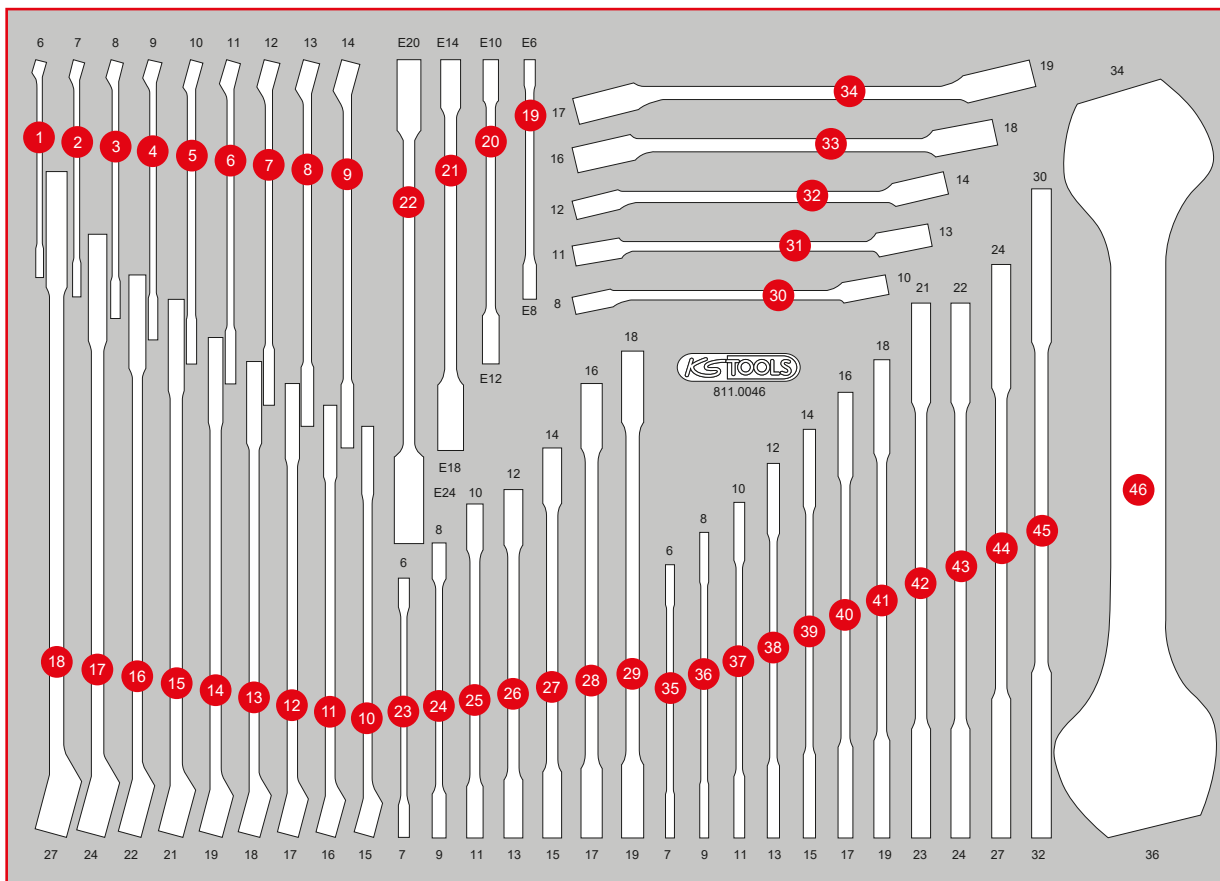

Pos.	Code	Description	pcs	Pos.	Code	Description	pcs	Pos.	Code	Description	pcs
25	920.0410	ULTIMATEplus Double ring ended spanner, 10 x 11 mm	1	30	517.0252	Open double ring spanner, offset, 8 x 10 mm	1	39	517.0709	Double open ended spanners, 14 x 15 mm	1
26	920.0412	ULTIMATEplus Double ring ended spanner, 12 x 13 mm	1	31	517.9244	Open double ring spanner, offset, 11 x 13 mm	1	40	517.0710	Double open ended spanners, 16 x 17 mm	1
27	920.0414	ULTIMATEplus Double ring ended spanner, 14 x 15 mm	1	32	517.0258	Open double ring spanner, offset, 12 x 14 mm	1	41	517.0712	Double open ended spanners, 18 x 19 mm	1
28	920.0416	ULTIMATEplus Double ring ended spanner, 16 x 17 mm	1	33	517.0263	Open double ring spanner, offset, 16 x 18 mm	1	42	517.0715	Double open ended spanners, 21 x 23 mm	1
29	920.0418	ULTIMATEplus Double ring ended spanner, 18 x 19 mm	1	34	517.0264	Open double ring spanner, offset, 17 x 19 mm	1	43	517.0736	Double open ended spanners, 22 x 24 mm	1
				35	517.0701	Double open ended spanners, 6 x 7 mm	1	44	517.0716	Double open ended spanners, 24 x 27 mm	1
				36	517.0702	Double open ended spanners, 8 x 9 mm	1	45	517.0718	Double open ended spanners, 30 x 32 mm	1
				37	517.0704	Double open ended spanners, 10 x 11 mm	1	46	517.0773	Double open ended spanners, 34 x 36 mm	1
				38	517.0707	Double open ended spanners, 12 x 13 mm	1				

811.1024

# M Screw spanner set



568 x 398



P10



P10TC



P15



P20



P30



P35



P45

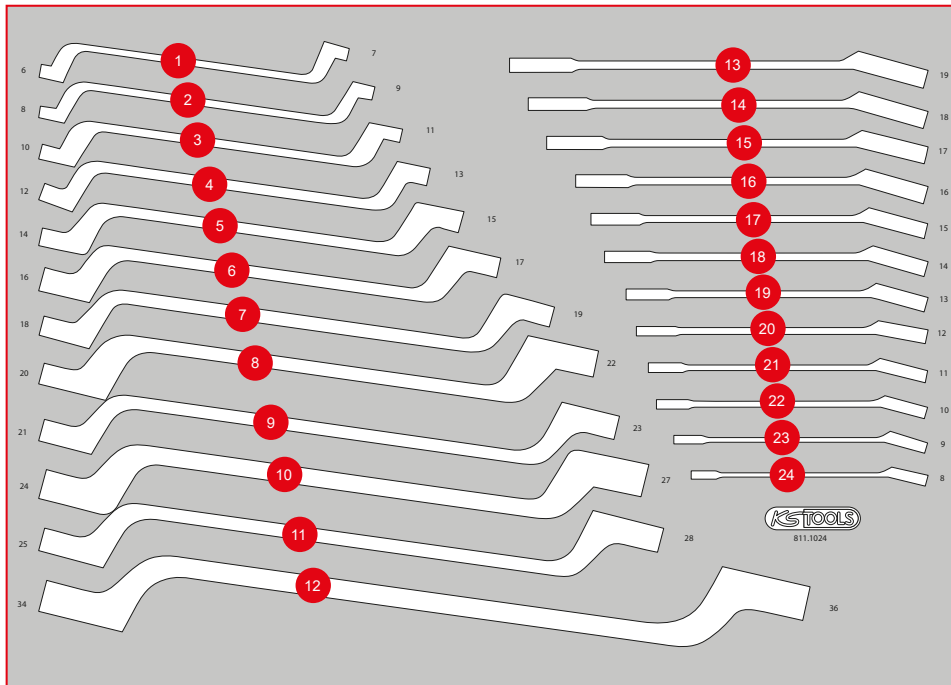

Pos.	Code	Description	pcs
1	517.0801	Double ring spanner, offset, 6 x 7 mm	1
2	517.0802	Double ring spanner, offset, 8 x 9 mm	1
3	517.0804	Double ring spanner, offset, 10 x 11 mm	1
4	517.0807	Double ring spanner, offset, 12 x 13 mm	1
5	517.0809	Double ring spanner, offset, 14 x 15 mm	1
6	517.0810	Double ring spanner, offset, 16 x 17 mm	1
7	517.0812	Double ring spanner, offset, 18 x 19 mm	1
8	517.0813	Double ring spanner, offset, 20 x 22 mm	1
9	517.0815	Double ring spanner, offset, 21 x 23 mm	1
10	517.0816	Double ring spanner, offset, 24 x 27 mm	1
11	517.0857	Double ring spanner, offset, 25 x 28 mm	1
12	517.0818	Double ring spanner, offset, 30 x 32 mm	1
13	503.4619	GEARplus reversing combination ratcheting spanner, 19 mm	1
14	503.4618	GEARplus reversing combination ratcheting spanner, 18 mm	1
15	503.4617	GEARplus reversing combination ratcheting spanner, 17 mm	1
16	503.4616	GEARplus reversing combination ratcheting spanner, 16 mm	1
17	503.4615	GEARplus reversing combination ratcheting spanner, 15 mm	1
18	503.4614	GEARplus reversing combination ratcheting spanner, 14 mm	1
19	503.4613	GEARplus reversing combination ratcheting spanner, 13 mm	1
20	503.4612	GEARplus reversing combination ratcheting spanner, 12 mm	1
21	503.4611	GEARplus reversing combination ratcheting spanner, 11 mm	1
22	503.4610	GEARplus reversing combination ratcheting spanner, 10 mm	1
23	503.4609	GEARplus reversing combination ratcheting spanner, 9 mm	1
24	503.4608	GEARplus reversing combination ratcheting spanner, 8 mm	1

811.0019

**M** Pliers and file set



568 x 398

P10

P10TC

P15

P20

P30

P35

P45



Pos.	Code	Description	pcs
1	157.0405	Tri-bastard file, form C, cut 2, 200 mm	1
2	157.0105	Halfround file, form E, cut 2, 20 mm	1
3	157.0005	Flat file, form B, cut 2, 200 mm	1
4	157.0205	Round file, form F, cut 2, 200 mm	1
5	907.2166	Snap off blades 0,5 x1 8 x 100 mm, dispenser with 10 pieces	10
6	300.0114	Tape measure with locking device and belt clip, black red, 5 m, 19 mm	1
7	300.0510	Pocket vernier calliper 0-150 mm, 235 mm	1
8	300.0600	Feeler gauge, 20 Blades, 0,05-1 mm	1
9	907.2135	Universal snap off blade knife 18 mm	1
10	115.1033	Self grip wrench, 220 mm	1
11	115.2010	Water pump pliers, 240 mm	1
12	500.1026	Circlip pliers for external circlips, angled, 160 mm	1
13	500.1029	Circlip pliers for external circlips, 160 mm	1
14	500.1032	Circlip pliers for internal circlips, angled, 160 mm	1
15	500.1035	Circlip pliers for internal circlips, 160 mm	1
16	115.1012	ERGOTORQUE diagonal side cutter, 160 mm	1
17	115.1021	ERGOTORQUE combination pliers, 180 mm	1
18	115.1019	ERGOTORQUE bent nose pliers serrated, 210 mm	1
19	115.1024	ERGOTORQUE long nose pliers serrated cutter, 200 mm	1

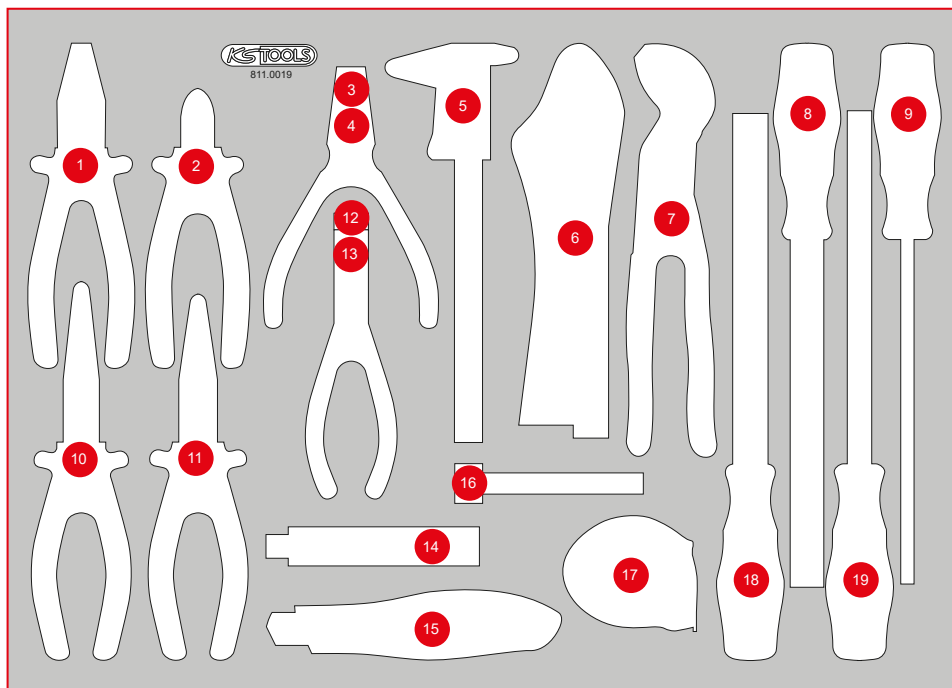

811.0022

**M** Hammer and chisel set



Pos.	Code	Description	pcs
1	911.8138	Trim plastic wedge, 195 x 30 mm	1
2	140.5252	Recoil free soft faced Hammer, 400 g	1
3	142.1402	Fitters Hammer, fiberglas handle, 400 g	1
4	142.5101	Club Hammer, fiberglas handle, 1000 g	1
5	550.1025	Flexible magnet lifter, 510 mm, Øhead=15 mm	1
6	550.1001	2in1 Telescopic solenoid holder with washer jet cleaning and setting tool, 150 - 675 mm	1
7	150.4370	perfectLight torch 85 lumen	1
8	911.8146	Tyre lever, 370 mm	1
9	201.2335	Steel wire brake saddle brush, 2-row, straight 225 mm	1
10	156.0241	Flat chisel, octagon, 20 mm	1
11	156.0254	Flat chisel, octagon, 18 mm	1
12	156.0242	Cross chisel, octagon, 7 mm	1
13	156.0243	Centre punch, octagon 10 mm	1
14	156.0244	Punch, Ø 5 mm, conical	1
15	156.0238	Punch, Ø 4 mm, conical	1
16	156.0237	Punch, Ø 3 mm, conical	1
17	156.0231	Pin punch, Ø 3 mm, cylindrical shaft	1
18	156.0232	Pin punch, Ø 4 mm, cylindrical shaft	1
19	156.0233	Pin punch, Ø 5 mm, cylindrical shaft	1
20	156.0234	Pin punch, Ø 6 mm, cylindrical shaft	1
21	156.0235	Pin punch, Ø 8 mm, cylindrical shaft	1
22	907.2232	Gasket scraper, 25 x 200 mm	1

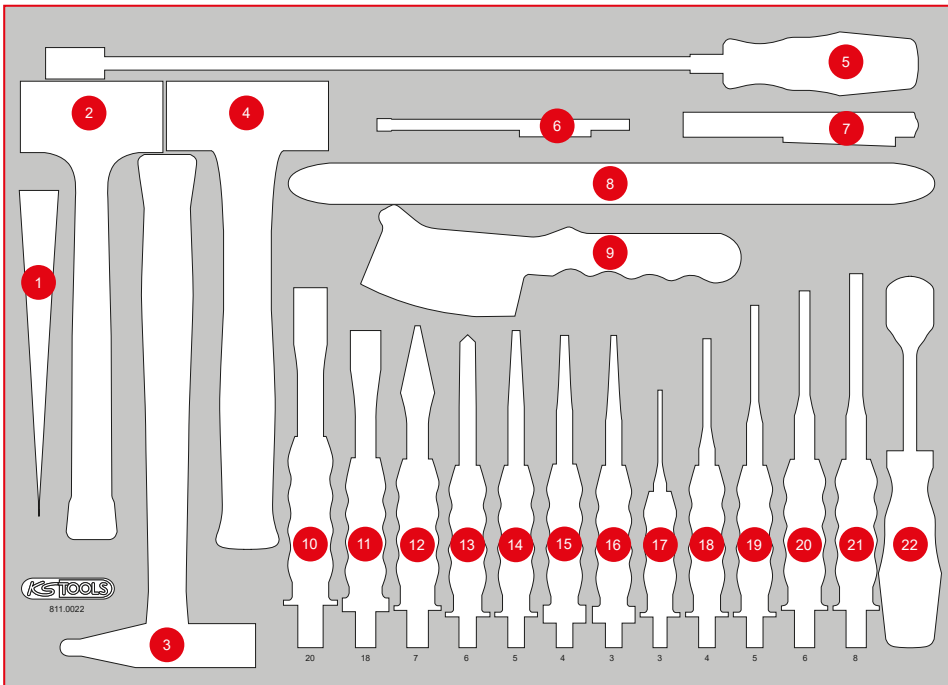

# P10

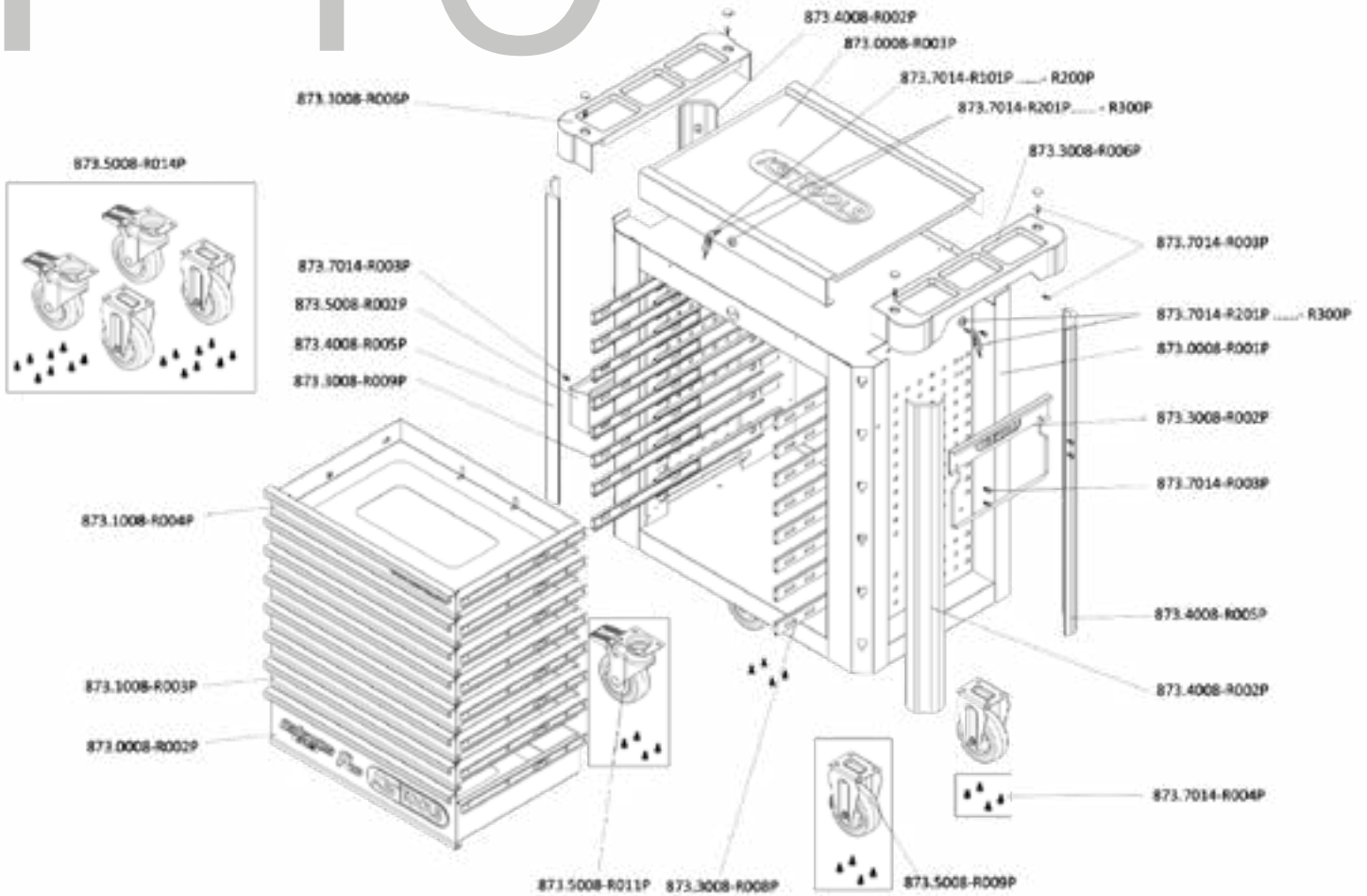

## INDIVIDUAL PARTS LIST

Item No.	Description	Amount
873.7014-R101P...	Replacement key for PERFORMANCEplus workshop trolley lock number xyz	2
873.7014-R201P...	Lock with 2 keys for PERFORMANCEplus workshop trolley lock number xyz	2
873.0008-R001P	Body with handle	1
873.0008-R002P	Compartment with logo and ball-bearing guide, 568x398x145 mm	1
873.0008-R003P	Stainless steel worktop	1
873.1008-R003P	Compartment with ball-bearing guide, for workshop trolley P10/P10TC/P15, 568x398x65 mm	6
873.1008-R004P	Compartment with website and ball-bearing guide, for workshop trolley P10/P15, 568x398x65 mm	1
873.3008-R002P	Paper roll holder for PERFORMANCEplus workshop trolley	1
873.3008-R006P	Storage for work surface	2
873.3008-R008P	Full extension (with ball-bearing guide) with automatic retraction	8
873.3008-R009P	Full extension (with ball-bearing guide) with automatic retraction	8
873.4008-R002P	Plastic bumpers	2
873.4008-R005P	Plastic bumpers	2
873.5008-R002P	Can holder for PERFORMANCEplus workshop trolley	1
873.5008-R009P	Fixed castors for PERFORMANCEplus workshop trolley, incl. screws	2
873.5008-R011P	Swivel castors with brakes, for PERFORMANCEplus workshop trolley, incl. screws	2
873.5008-R014P	Roller set for PERFORMANCEplus workshop trolley, incl. screws	1
873.7014-R003P	M6x12 screws for PERFORMANCEplus workshop trolley accessories	14
873.7014-R004P	M8 screws for PERFORMANCEplus workshop trolley rollers (16 pcs.)	1



**873.7014-R101P...R200P**  
Replacement key for lock number xyz



**873.7014-R201P...R300P**  
Lock with 2 keys for lock number xyz



**873.3008-R008P**  
Full extension (with ball-bearing guide) with automatic retraction, right



**873.3008-R009P**  
Full extension (with ball-bearing guide) with automatic retraction, left



**873.5008-R009P**  
Fixed castors, incl. screws



**873.5008-R011P**  
Swivel castors with brakes, incl. screws

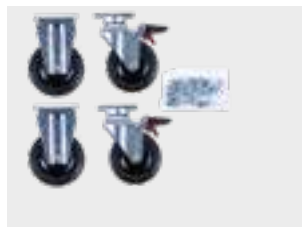

**873.5008-R014P**  
Roller set, incl. screws



**873.0008-R003P**  
Stainless steel work surface



**873.3008-R006P**  
Storage for work surface, including screw cover, usable on both sides



**873.1008-R004P**  
Compartment with website and ball-bearing guide, 568x398x65 mm



**873.1008-R003P**  
Compartment with ball-bearing guide, 568x398x65 mm



**873.0008-R002P**  
Compartment with logo and ball-bearing guide, 568x398x145 mm



**873.5008-R002P**  
Can holder, 310 mm



**873.3008-R002P**  
Paper roll holder, 320 mm



**873.4008-R005P**  
Plastic bumpers, front left, back right



**873.4008-R002P**  
Plastic bumpers, front right, back left



**873.7014-R004P**  
M8 screws (16 pcs.)



**873.7014-R003P**  
M6x12 screw (1 pcs.)



**873.0008-R001P**  
Body with handle



A thousand great parts for tough guys!

