

P10

workshop tool trolley
with 399 tools for 6 drawers
810.6399

Workshop trolley P10

with 8 compartments

873.0008

THE ENTRY MODEL TO SATISFY HIGH STANDARDS



P10



DUO Lock Brilliant locking system



Eight drawers each load capacity up to 50 kg



Stable **ball bearing**



Stainless steel surface



Lock lockable



Anti-static castors with brakes



Integrated **corner protection**



Paper roll holder included



Can holder included

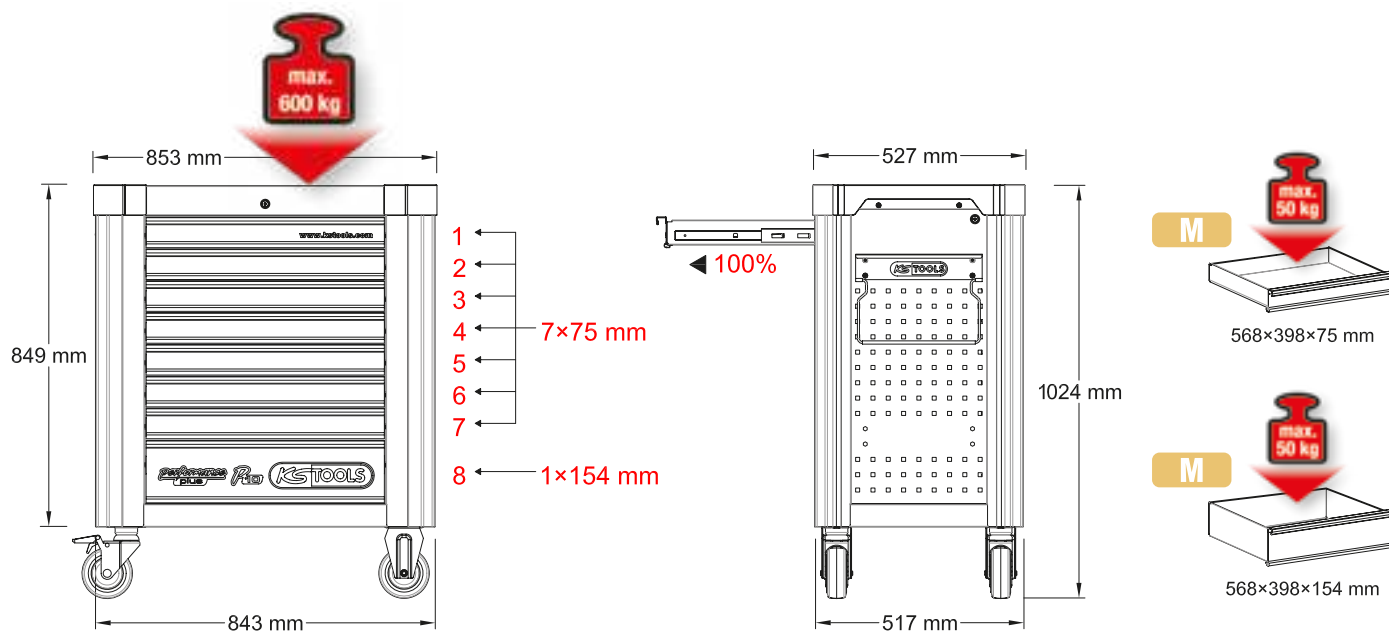

P10 workshop tool trolley set with 399 tools for 6 drawers

810.6399

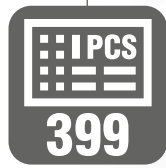

M

BUNDLE PRICE!

6 x M / 399 pcs

2.099,^{EUR}-

810.6399

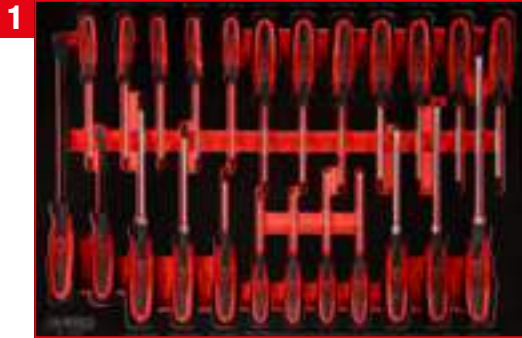

1



Screwdriver set in foam insert

811.0024

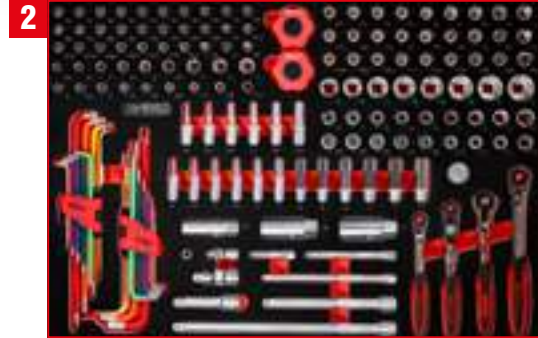

2



1/4" + 3/8" socket spanner set
in foam insert

811.0156



3



1/2" socket spanner set in foam insert

811.0095



4



Screw spanner set in foam insert

811.1040



5



Screw spanner set in foam insert

811.0051



6



Pliers, hammer and chisel set in foam
insert

811.0033

811.0024

M Screwdriver set

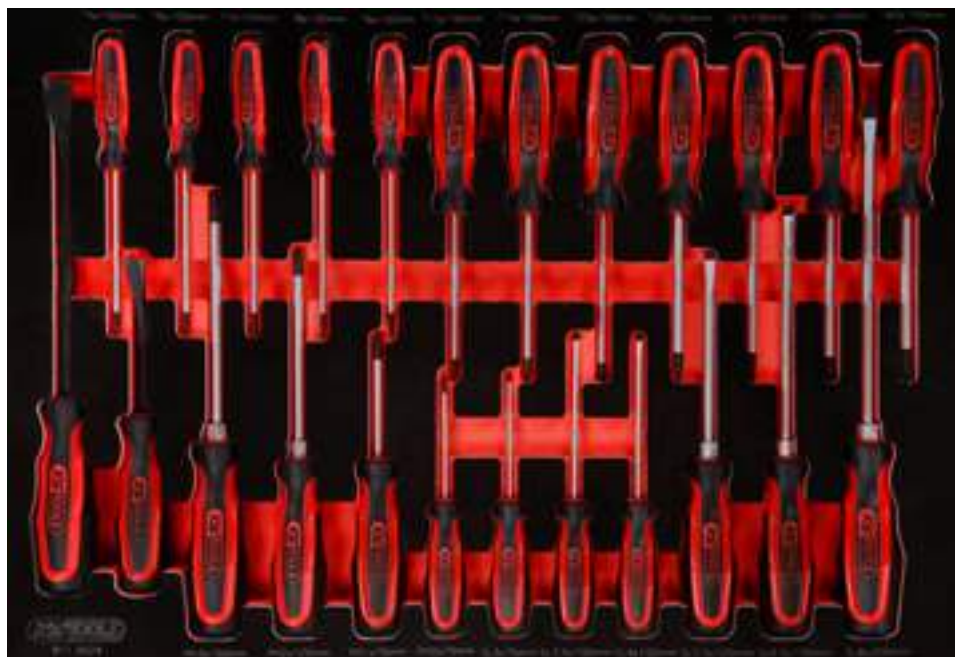

Pos.	Code	Description	pcs
1	911.8102	Pry bar, 15 x 185 mm	1
2	911.8101	Pry bar, 11 x 115 mm	1
3	159.1133	ERGOTORQUEplus screwdriver, Torx, T5	1
4	159.1134	ERGOTORQUEplus screwdriver, Torx, T6	1
5	159.1135	ERGOTORQUEplus screwdriver, Torx, T7	1
6	159.1030	ERGOTORQUEplus screwdriver, Torx, T8	1
7	159.1031	ERGOTORQUEplus screwdriver, Torx, T9	1
8	159.1032	ERGOTORQUEplus screwdriver, Torx, T10	1
9	159.1033	ERGOTORQUEplus screwdriver, Torx, T15	1
10	159.1034	ERGOTORQUEplus screwdriver, Torx, T20	1
11	159.1035	ERGOTORQUEplus screwdriver, Torx, T25	1
12	159.1036	ERGOTORQUEplus screwdriver, Torx, T27	1
13	159.1037	ERGOTORQUEplus screwdriver, Torx, T30	1
14	159.1038	ERGOTORQUEplus screwdriver, Torx, T40	1
15	159.1024	ERGOTORQUEplus screwdriver, Torx, PH3, 265 mm	1
16	159.1022	ERGOTORQUEplus screwdriver, Torx, PH2, 230 mm	1
17	159.1020	ERGOTORQUEplus screwdriver, Torx, PH1, 180 mm	1
18	159.1027	ERGOTORQUEplus screwdriver, Torx, PH0, 155 mm	1
19	159.1002	ERGOTORQUEplus screwdriver for slotted screws, 3 mm, 155 mm	1
20	159.1112	ERGOTORQUEplus screwdriver for slotted screws, 3,5 mm, 180 mm	1
21	159.1004	ERGOTORQUEplus screwdriver for slotted screws, 4 mm, 180 mm	1
22	159.1006	ERGOTORQUEplus screwdriver for slotted screws, 5,5 mm, 230 mm	1
23	159.1009	ERGOTORQUEplus screwdriver for slotted screws, 6,5 mm, 255 mm	1
24	159.1011	ERGOTORQUEplus screwdriver for slotted screws, 8 mm, 315 mm	1

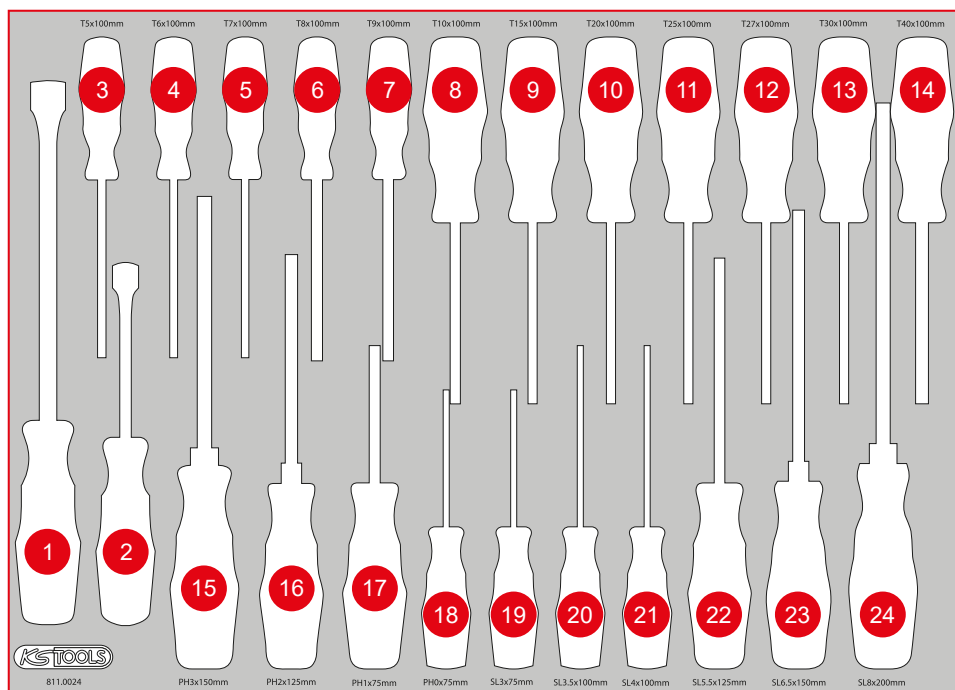

M 1/4" + 3/8" socket spanner set

Pos.	Code	Description	pcs	Pos.	Code	Description	pcs	Pos.	Code	Description	pcs
1	920.3890	3/8" SlimPOWER Reversible ratchet, 72 teeth	1	22	917.1527	1/4" Hexagonal socket, deep, 5 mm	1	46	917.1410	1/4" Hexagonal socket, 10 mm	1
2	914.1405	1/4" MODIFIX mini T-handle swivel head ratchet, 72 teeth	1	23	917.1528	1/4" Hexagonal socket, deep, 5,5 mm	1	47	917.1411	1/4" Hexagonal socket, 11 mm	1
3	914.1420	1/4" SlimPOWER telescopic-joint reversible ratchet, 72 teeth	1	24	917.1426	1/4" Hexagonal socket, deep, 6 mm	1	48	917.1412	1/4" Hexagonal socket, 12 mm	1
4	920.1490	1/4" SlimPOWER Reversible ratchet, 72 teeth	1	25	917.1427	1/4" Hexagonal socket, deep, 7 mm	1	49	917.1413	1/4" Hexagonal socket, 13 mm	1
5	911.1423	1/4" Extension with hexagon drive, 50 mm	1	26	917.1428	1/4" Hexagonal socket, deep, 8 mm	1	50	911.4313	1/4" Torx E Socket, E4	1
6	911.1424	1/4" Extension with hexagon drive, 100 mm	1	27	917.1429	1/4" Hexagonal socket, deep, 9 mm	1	51	911.4314	1/4" Torx E Socket, E5	1
7	911.1451	1/4" Extension with hexagon drive, 150 mm	1	28	917.1430	1/4" Hexagonal socket, deep, 10 mm	1	52	911.4315	1/4" Torx E Socket, E6	1
8	911.3801	3/8" Extension with knurling, 75 mm	1	29	917.1431	1/4" Hexagonal socket, deep, 11 mm	1	53	911.4316	1/4" Torx E Socket, E7	1
9	911.3802	3/8" Extension with knurling, 150 mm	1	30	917.1432	1/4" Hexagonal socket, deep, 12 mm	1	54	911.4317	1/4" Torx E Socket, E8	1
10	911.3803	3/8" Extension with knurling, 250 mm	1	31	917.1433	1/4" Hexagonal socket, deep, 13 mm	1	55	911.4332	1/4" Torx E Socket, E10	1
11	911.1450	1/4" Universal joint	1	32	917.2401	1/4" Torx E Socket, deep, E4	1	56	911.4407	1/4" Bit socket Torx, T6	1
12	911.3850	3/8" Universal joint	1	33	917.2402	1/4" Torx E Socket, deep, E5	1	57	911.4362	1/4" Bit socket Torx, T7	1
13	911.0101	1/4" socket with magnet	1	34	917.2403	1/4" Torx E Socket, deep, E6	1	58	911.1448	1/4" Bit socket Torx, T8	1
14	911.3804	3/8" Spark plug socket, 16 mm	1	35	917.2404	1/4" Torx E Socket, deep, E7	1	59	911.1478	1/4" Bit socket Torx, T9	1
15	911.3823	3/8" Spark plug socket, 18 mm	1	36	917.2405	1/4" Torx E Socket, deep, E8	1	60	911.1442	1/4" Bit socket Torx, T10	1
16	911.3805	3/8" Spark plug socket, 21 mm	1	37	917.2406	1/4" Torx E Socket, deep, E10	1	61	911.1443	1/4" Bit socket Torx, T15	1
17	911.3826	3/8" Sliding / reducing adaptor, 1/2" F x 3/8" M	1	38	917.1404	1/4" Hexagonal socket, 4 mm	1	62	911.1444	1/4" Bit socket Torx, T20	1
18	151.4530	Ball ended Torx key wrench set, extra long and bent 108°, 9 pcs	9	39	917.14045	1/4" Hexagonal socket, 4,5 mm	1	63	911.1445	1/4" Bit socket Torx, T25	1
19	151.4420	Ball ended hexagon key wrench set, extra long, 9 pcs	9	40	917.1405	1/4" Hexagonal socket, 5 mm	1	64	917.1456	1/4" Bit socket Torx tamperproof, TB6	1
20	917.1525	1/4" Hexagonal socket, deep, 4 mm	1	41	917.14055	1/4" Hexagonal socket, 5,5 mm	1	65	917.1457	1/4" Bit socket Torx tamperproof, TB7	1
21	917.1526	1/4" Hexagonal socket, deep, 4,5 mm	1	42	917.1406	1/4" Hexagonal socket, 6 mm	1	66	911.1461	1/4" Bit socket Torx tamperproof, TB8	1
				43	917.1407	1/4" Hexagonal socket, 7 mm	1	67	911.1485	1/4" Bit socket Torx tamperproof, TB9	1
				44	917.1408	1/4" Hexagonal socket, 8 mm	1	68	911.1462	1/4" Bit socket Torx tamperproof, TB10	1
				45	917.1409	1/4" Hexagonal socket, 9 mm	1	69	911.1463	1/4" Bit socket Torx tamperproof, TB15	1

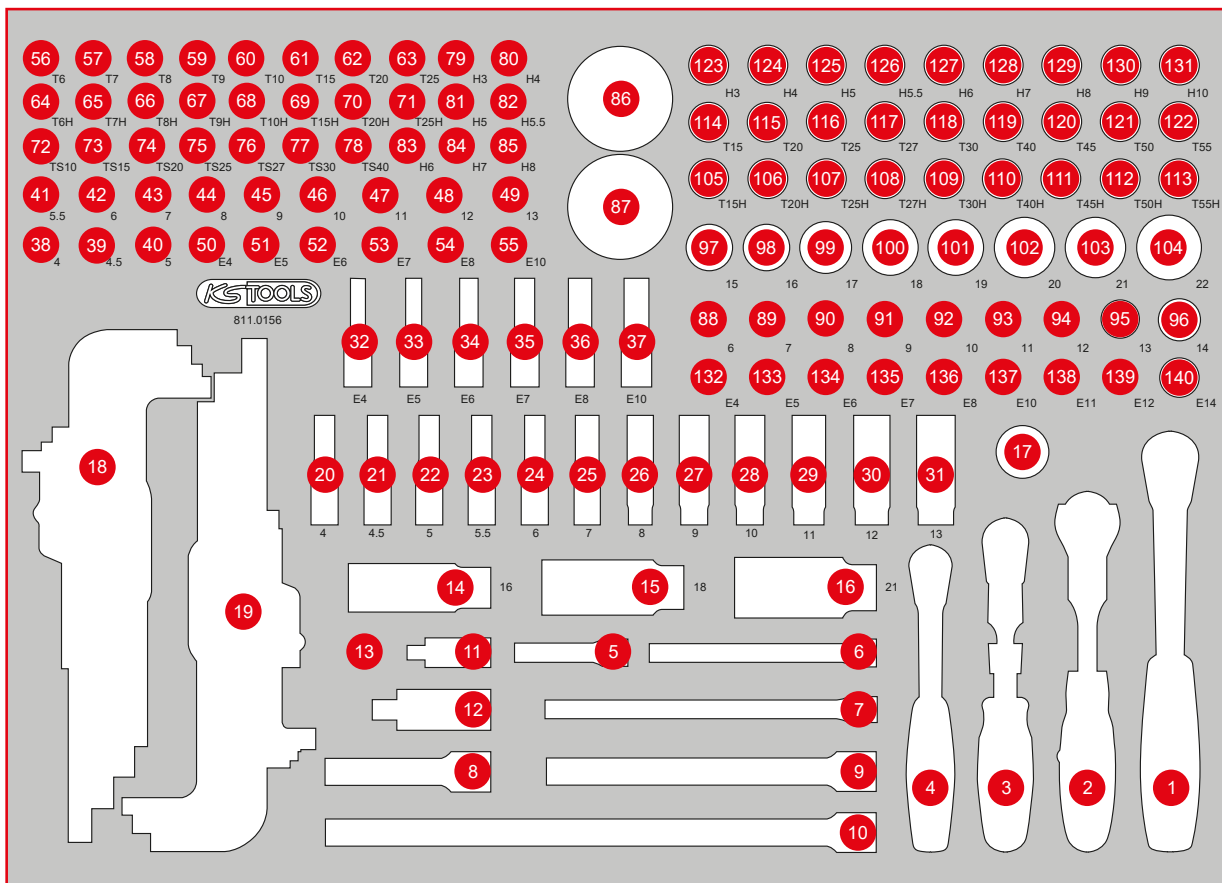

Pos.	Code	Description	pcs	Pos.	Code	Description	pcs	Pos.	Code	Description	pcs
70	911.1464	1/4" Bit socket Torx tamperproof, TB20	1	94	917.3812	3/8" Hexagonal socket, 12 mm	1	118	911.3873	3/8" Bit socket Torx, T30	1
71	911.1465	1/4" Bit socket Torx tamperproof, TB25	1	95	917.3813	3/8" Hexagonal socket, 13 mm	1	119	911.3874	3/8" Bit socket Torx, T40	1
72	911.1701	1/4" Bit socket five star tamperproof, TS10	1	96	917.3814	3/8" Hexagonal socket, 14 mm	1	120	911.3885	3/8" Bit socket Torx, T45	1
73	911.1702	1/4" Bit socket five star tamperproof, TS15	1	97	917.3815	3/8" Hexagonal socket, 15 mm	1	121	911.3884	3/8" Bit socket Torx, T50	1
74	911.1703	1/4" Bit socket five star tamperproof, TS20	1	98	917.3816	3/8" Hexagonal socket, 16 mm	1	122	911.3888	3/8" Bit socket Torx, T55	1
75	911.1704	1/4" Bit socket five star tamperproof, TS25	1	99	917.3817	3/8" Hexagonal socket, 17 mm	1	123	911.3863	3/8" Bit socket hexagon, 3 mm	1
76	911.1705	1/4" Bit socket five star tamperproof, TS27	1	100	917.3818	3/8" Hexagonal socket, 18 mm	1	124	911.3864	3/8" Bit socket hexagon, 4 mm	1
77	911.1706	1/4" Bit socket five star tamperproof, TS30	1	101	917.3819	3/8" Hexagonal socket, 19 mm	1	125	911.3865	3/8" Bit socket hexagon, 5 mm	1
78	911.1707	1/4" Bit socket five star tamperproof, TS40	1	102	917.3820	3/8" Hexagonal socket, 20 mm	1	126	911.38655	3/8" Bit socket hexagon, 5,5 mm	1
79	911.1436	1/4" Bit socket hexagon, 3 mm	1	103	917.3821	3/8" Hexagonal socket, 21 mm	1	127	911.3866	3/8" Bit socket hexagon, 6 mm	1
80	911.1437	1/4" Bit socket hexagon, 4 mm	1	104	917.3822	3/8" Hexagonal socket, 22 mm	1	128	911.3867	3/8" Bit socket hexagon, 7 mm	1
81	911.1438	1/4" Bit socket hexagon, 5 mm	1	105	911.3961	3/8" Bit socket Torx tamperproof, TB15	1	129	911.3868	3/8" Bit socket hexagon, 8 mm	1
82	911.14385	1/4" Bit socket hexagon, 5,5 mm	1	106	911.3962	3/8" Bit socket Torx tamperproof, TB20	1	130	917.3969	3/8" Bit socket hexagon, 9 mm	1
83	911.1439	1/4" Bit socket hexagon, 6 mm	1	107	911.3963	3/8" Bit socket Torx tamperproof, TB25	1	131	917.3857	3/8" Bit socket hexagon, 10 mm	1
84	911.1440	1/4" Bit socket hexagon, 7 mm	1	108	911.3964	3/8" Bit socket Torx tamperproof, TB27	1	132	911.4338	3/8" Torx E Socket, E4	1
85	911.1441	1/4" Bit socket hexagon, 8 mm	1	109	911.3965	3/8" Bit socket Torx tamperproof, TB30	1	133	911.4339	3/8" Torx E Socket, E5	1
86	914.1410	Mini hand reversible ratchet, 1/4", 72 teethh	1	110	911.3966	3/8" Bit socket Torx tamperproof, TB40	1	134	911.4340	3/8" Torx E Socket, E6	1
87	914.3810	Mini hand reversible ratchet, 3/8", 72 teethh	1	111	911.3967	3/8" Bit socket Torx tamperproof, TB45	1	135	911.4341	3/8" Torx E Socket, E7	1
88	917.3806	3/8" Hexagonal socket, 6 mm	1	112	911.3968	3/8" Bit socket Torx tamperproof, TB50	1	136	911.4342	3/8" Torx E Socket, E8	1
89	917.3807	3/8" Hexagonal socket, 7 mm	1	113	911.3969	3/8" Bit socket Torx tamperproof, TB55	1	137	911.4318	3/8" Torx E Socket, E10	1
90	917.3808	3/8" Hexagonal socket, 8 mm	1	114	911.3869	3/8" Bit socket Torx, T15	1	138	911.4319	3/8" Torx E Socket, E11	1
91	917.3809	3/8" Hexagonal socket, 9 mm	1	115	911.3870	3/8" Bit socket Torx, T20	1	139	911.4320	3/8" Torx E Socket, E12	1
92	917.3810	3/8" Hexagonal socket, 10 mm	1	116	911.3871	3/8" Bit socket Torx, T25	1	140	911.4321	3/8" Torx E Socket, E14	1
93	917.3811	3/8" Hexagonal socket, 11 mm	1	117	911.3872	3/8" Bit socket Torx, T27	1				

1/2" Socket spanner set

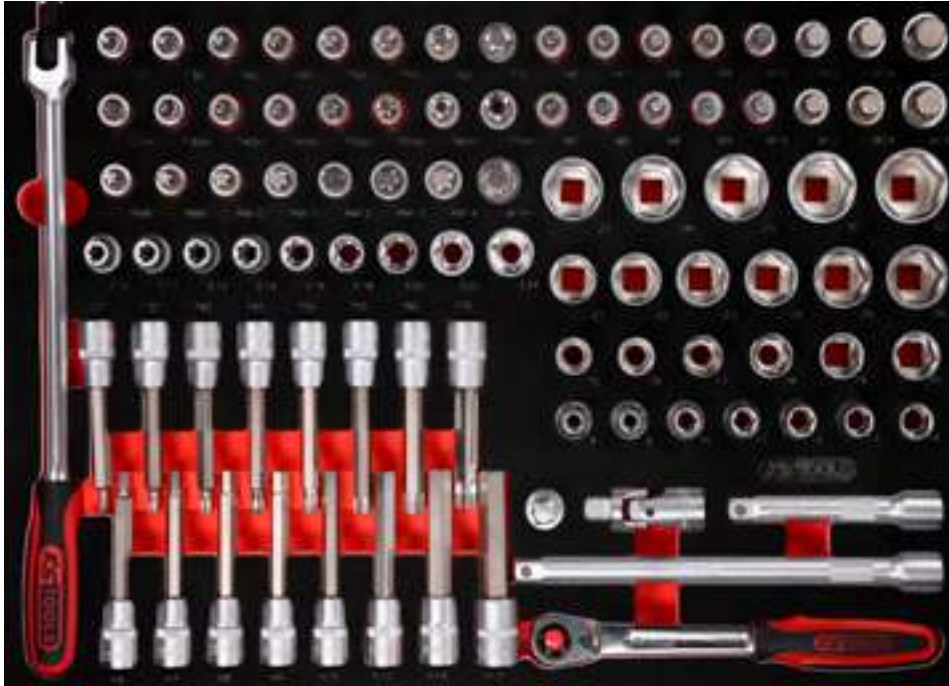

334,90 EUR

95

568 x 398

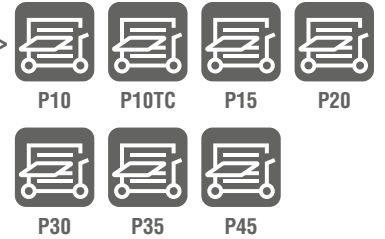

Pos.	Code	Description	pcs	Pos.	Code	Description	pcs	Pos.	Code	Description	pcs
1	917.1455	1/2" Flexi head drive handle	1	18	911.1373	1/2" Bit socket Torx tamperproof, TB27	1	35	911.4515	Bit socket for RIBE screws, M9, length 55 mm	1
2	911.1363	1/2" Bit socket Torx, T27	1	19	911.1374	1/2" Bit socket Torx tamperproof, TB30	1	36	911.4516	Bit socket for RIBE screws, M10, length 55 mm	1
3	911.1364	1/2" Bit socket Torx, T30	1	20	911.1375	1/2" Bit socket Torx tamperproof, TB40	1	37	911.4551	Bit socket for RIBE screws, M10.1, length 55 mm	1
4	911.1365	1/2" Bit socket Torx, T40	1	21	911.1376	1/2" Bit socket Torx tamperproof, TB45	1	38	911.4517	Bit socket for RIBE screws, M12, length 55 mm	1
5	911.1366	1/2" Bit socket Torx, T45	1	22	911.1377	1/2" Bit socket Torx tamperproof, TB50	1	39	911.4518	Bit socket for RIBE screws, M13, length 55 mm	1
6	911.1367	1/2" Bit socket Torx, T50	1	23	911.1378	1/2" Bit socket Torx tamperproof, TB55	1	40	911.4519	Bit socket for RIBE screws, M14, length 55 mm	1
7	911.1368	1/2" Bit socket Torx, T55	1	24	911.1379	1/2" Bit socket Torx tamperproof, TB60	1	41	911.1348	1/2" Bit socket spline (XZN) tamperproof, M16, 55 mm	1
8	911.1369	1/2" Bit socket Torx, T60	1	25	911.1380	1/2" Bit socket Torx tamperproof, TB70	1	42	917.1227	1/2" Hexagonal socket, 27 mm	1
9	911.1370	1/2" Bit socket Torx, T70	1	26	911.1340	1/2" Bit socket spline (XZN), M5, 55 mm	1	43	917.1344	1/2" Hexagonal socket, 28 mm	1
10	911.1306	1/2" Bit socket hexagon, short, 6 mm	1	27	911.1341	1/2" Bit socket spline (XZN), M6, 55 mm	1	44	917.1345	1/2" Hexagonal socket, 29 mm	1
11	911.1307	1/2" Bit socket hexagon, short, 7 mm	1	28	911.1342	1/2" Bit socket spline (XZN), M8, 55 mm	1	45	917.1230	1/2" Hexagonal socket, 30 mm	1
12	911.1308	1/2" Bit socket hexagon, short, 8 mm	1	29	911.1313	1/2" Bit socket spline (XZN), M9, 55 mm	1	46	917.1232	1/2" Hexagonal socket, 32 mm	1
13	911.1309	1/2" Bit socket hexagon, short, 9 mm	1	30	911.1343	1/2" Bit socket spline (XZN), M10, 55 mm	1	47	911.4333	1/2" Torx E Socket, E10	1
14	911.1310	1/2" Bit socket hexagon, short, 10 mm	1	31	911.1344	1/2" Bit socket spline (XZN), M12, 55 mm	1	48	911.4334	1/2" Torx E Socket, E11	1
15	911.1312	1/2" Bit socket hexagon, short, 12 mm	1	32	911.1345	1/2" Bit socket spline (XZN), M14, 55 mm	1	49	911.4335	1/2" Torx E Socket, E12	1
16	911.1314	1/2" Bit socket hexagon, short, 14 mm	1	33	911.1346	1/2" Bit socket spline (XZN), M16, 55 mm	1	50	911.4336	1/2" Torx E Socket, E14	1
17	911.1317	1/2" Bit socket hexagon, short, 17 mm	1	34	911.4514	Bit socket for RIBE screws, M8, length 55 mm	1				

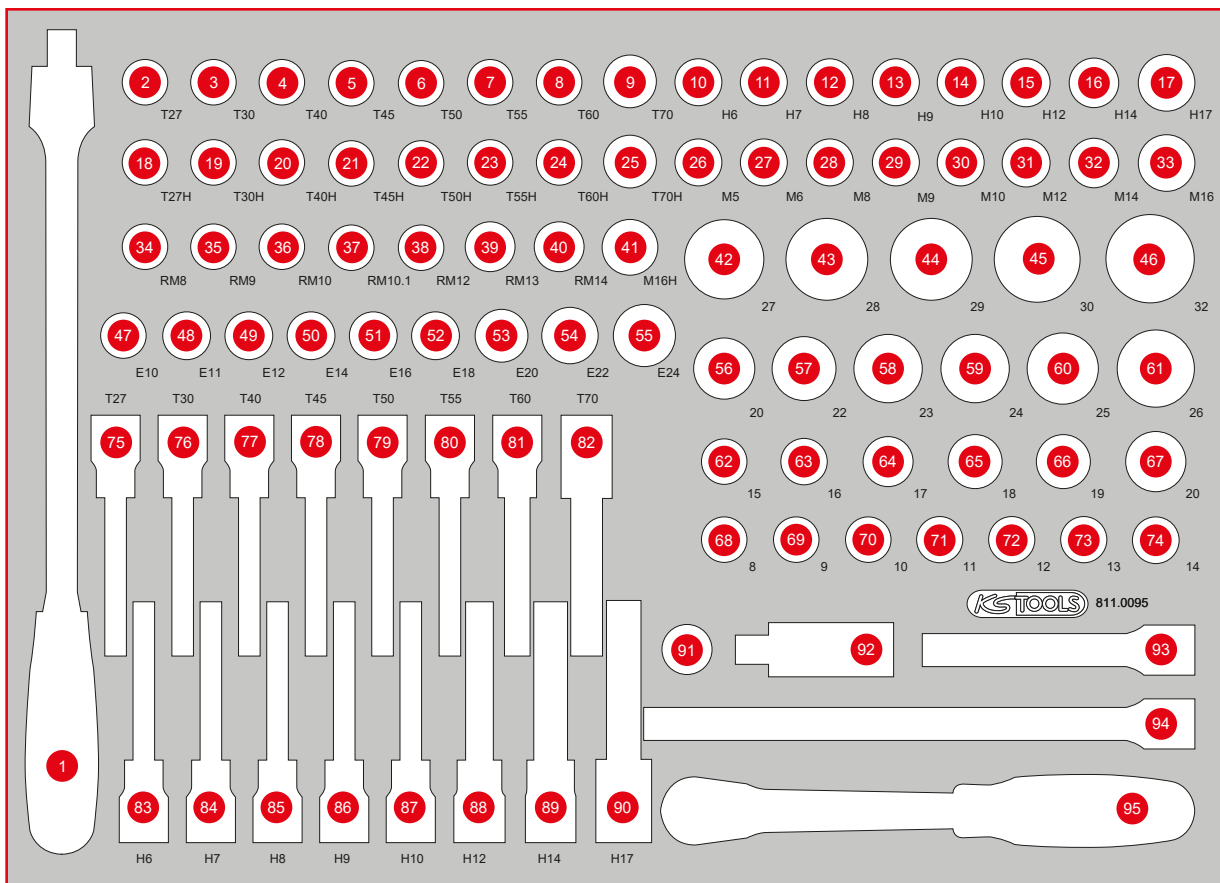

Pos.	Code	Description	pcs	Pos.	Code	Description	pcs	Pos.	Code	Description	pcs
51	911.4322	1/2" Torx E Socket, E16	1	68	917.1340	1/2" Hexagonal socket, 8 mm	1	77	911.1525	1/2" Bit socket Torx, long, T40	1
52	911.4323	1/2" Torx E Socket, E18	1	69	917.1341	1/2" Hexagonal socket, 9 mm	1	78	911.1526	1/2" Bit socket Torx, long, T45	1
53	911.4324	1/2" Torx E Socket, E20	1	70	917.1210	1/2" Hexagonal socket, 10 mm	1	79	911.1527	1/2" Bit socket Torx, long, T50	1
54	911.4325	1/2" Torx E Socket, E22	1	71	917.1211	1/2" Hexagonal socket, 11 mm	1	80	911.1528	1/2" Bit socket Torx, long, T55	1
55	911.4326	1/2" Torx E Socket, E24	1	72	917.1212	1/2" Hexagonal socket, 12 mm	1	81	911.1529	1/2" Bit socket Torx, long, T60	1
56	917.1221	1/2" Hexagonal socket, 21 mm	1	73	917.1213	1/2" Hexagonal socket, 13 mm	1	82	911.1517	1/2" Bit socket Torx, long, T70	1
57	917.1222	1/2" Hexagonal socket, 22 mm	1	74	917.1214	1/2" Hexagonal socket, 14 mm	1	91	911.1207	3/8" Sliding adaptor, 3/8" F x 1/2" M	1
58	917.1223	1/2" Hexagonal socket, 23 mm	1	83	911.1326	1/2" Bit socket hexagon, long, 6 mm	1	92	911.1250	1/2" Universal joint	1
59	917.1224	1/2" Hexagonal socket, 24 mm	1	84	911.1327	1/2" Bit socket hexagon, long, 7 mm	1	93	911.1202	1/2" Extensions, 125 mm	1
60	917.1342	1/2" Hexagonal socket, 25 mm	1	85	911.1328	1/2" Bit socket hexagon, long, 8 mm	1	94	911.1203	1/2" Extensions, 250 mm	1
61	917.1343	1/2" Hexagonal socket, 26 mm	1	86	911.1329	1/2" Bit socket hexagon, long, 9 mm	1	95	920.1290	1/2" SlimPOWER Reversible ratchet, 72 teeth	1
62	917.1215	1/2" Hexagonal socket, 15 mm	1	87	911.1330	1/2" Bit socket hexagon, long, 10 mm	1				
63	917.1216	1/2" Hexagonal socket, 16 mm	1	88	911.1332	1/2" Bit socket hexagon, long, 12 mm	1				
64	917.1217	1/2" Hexagonal socket, 17 mm	1	89	917.1332	1/2" Bit socket hexagon, long, 14 mm	1				
65	917.1218	1/2" Hexagonal socket, 18 mm	1	90	911.1337	1/2" Bit socket hexagon, long, 17 mm	1				
66	917.1219	1/2" Hexagonal socket, 19 mm	1	75	911.1523	1/2" Bit socket Torx, long, T27	1				
67	917.1220	1/2" Hexagonal socket, 20 mm	1	76	911.1524	1/2" Bit socket Torx, long, T30	1				

811.1040

M Screw spanner set

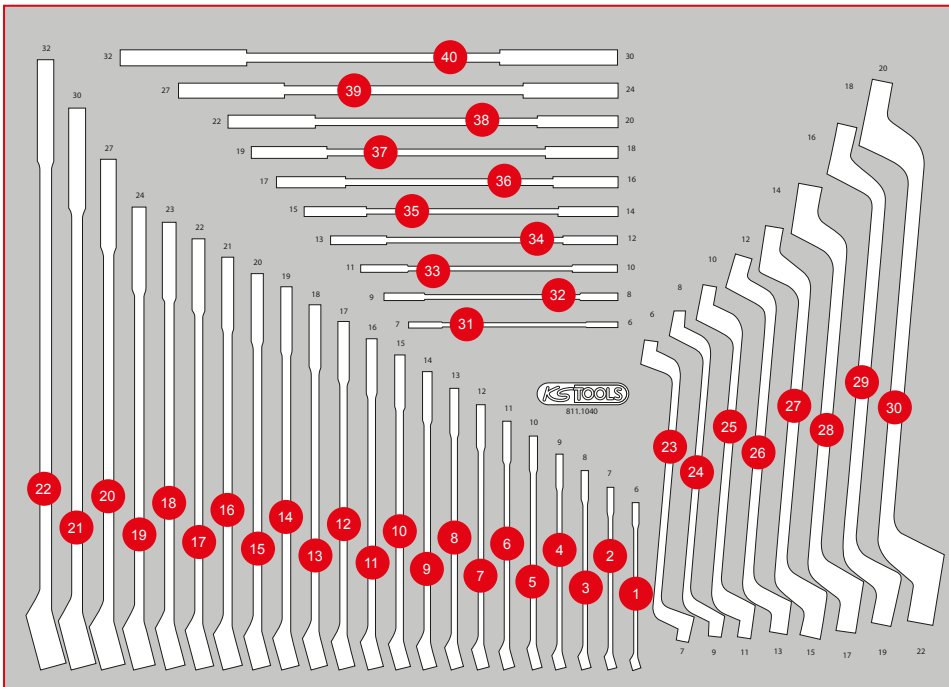

Pos.	Code	Description	pcs
1	517.0606	Combination spanners, offset, 6 mm	1
2	517.0607	Combination spanners, offset, 7 mm	1
3	517.0608	Combination spanners, offset, 8 mm	1
4	517.0609	Combination spanners, offset, 9 mm	1
5	517.0610	Combination spanners, offset, 10 mm	1
6	517.0611	Combination spanners, offset, 11 mm	1
7	517.0612	Combination spanners, offset, 12 mm	1
8	517.0613	Combination spanners, offset, 13 mm	1
9	517.0614	Combination spanners, offset, 14 mm	1
10	517.0615	Combination spanners, offset, 15 mm	1
11	517.0616	Combination spanners, offset, 16 mm	1
12	517.0617	Combination spanners, offset, 17 mm	1
13	517.0618	Combination spanners, offset, 18 mm	1
14	517.0619	Combination spanners, offset, 19 mm	1
15	517.0620	Combination spanners, offset, 20 mm	1
16	517.0621	Combination spanners, offset, 21 mm	1
17	517.0622	Combination spanners, offset, 22 mm	1
18	517.0623	Combination spanners, offset, 23 mm	1
19	517.0624	Combination spanners, offset, 24 mm	1
20	517.0627	Combination spanners, offset, 27 mm	1
21	517.0630	Combination spanners, offset, 30 mm	1
22	517.0632	Combination spanners, offset, 32 mm	1
23	517.0701	Double open ended spanners, 6 x 7 mm	1
24	517.0702	Double open ended spanners, 8 x 9 mm	1
25	517.0704	Double open ended spanners, 10 x 11 mm	1
26	517.0707	Double open ended spanners, 12 x 13 mm	1
27	517.0709	Double open ended spanners, 14 x 15 mm	1
28	517.0710	Double open ended spanners, 16 x 17 mm	1
29	517.0712	Double open ended spanners, 18 x 19 mm	1
30	517.0714	Double open ended spanners, 20 x 22 mm	1
31	517.0716	Double open ended spanners, 24 x 27 mm	1
32	517.0718	Double open ended spanners, 30 x 32 mm	1
33	517.0801	Double ring spanner, offset, 6 x 7 mm	1
34	517.0802	Double ring spanner, offset, 8 x 9 mm	1
35	517.0804	Double ring spanner, offset, 10 x 11 mm	1
36	517.0807	Double ring spanner, offset, 12 x 13 mm	1
37	517.0809	Double ring spanner, offset, 14 x 15 mm	1
38	517.0810	Double ring spanner, offset, 16 x 17 mm	1
39	517.0812	Double ring spanner, offset, 18 x 19 mm	1
40	517.0813	Double ring spanner, offset, 20 x 22 mm	1

M Screw spanner set



568 x 398



P10



P10TC



P15



P20



P30



P35



P45



Pos.	Code	Description	pcs	Pos.	Code	Description	pcs	Pos.	Code	Description	pcs
1	518.0856	CHROMEplus Starter and block spanner, 14 x 17 mm	1	13	517.0258	Open double ring spanner, offset, 12 x 14 mm	1	25	920.0414	ULTIMATEplus Double ring ended spanner, 14 x 15 mm	1
2	518.0853	CHROMEplus Starter and block spanner, 11 x 13 mm	1	14	517.9244	Open double ring spanner, offset, 11 x 13 mm	1	26	920.0412	ULTIMATEplus Double ring ended spanner, 12 x 13 mm	1
3	518.0852	CHROMEplus Starter and block spanner, 10 x 12 mm	1	15	517.0252	Open double ring spanner, offset, 8 x 10 mm	1	27	920.0410	ULTIMATEplus Double ring ended spanner, 10 x 11 mm	1
4	503.4290	GEARplus bit adaptor, 1/4" x 10 mm	1	16	517.0300	Double revolving head spanner, 6 x 7 mm	1	28	920.0408	ULTIMATEplus Double ring ended spanner, 8 x 9 mm	1
5	503.4296	GEARplus socket adaptor, 1/4" x 10 mm	1	17	517.0301	Double revolving head spanner, 8 x 9 mm	1	29	920.0406	ULTIMATEplus Double ring ended spanner, 6 x 7 mm	1
6	503.4297	GEARplus socket adaptor, 3/8" x 13 mm	1	18	517.0302	Double revolving head spanner, 10 x 11 mm	1	30	518.0017	CHROMEplus Combination spanner, stubby, 17 mm	1
7	503.4298	GEARplus socket adaptor, 1/2" x 19 mm	1	19	517.0303	Double revolving head spanner, 12 x 13 mm	1	31	518.0016	CHROMEplus Combination spanner, stubby, 16 mm	1
8	517.0269	Open double ring spanner, offset, 30 x 32 mm	1	20	517.0304	Double revolving head spanner, 14 x 15 mm	1	32	518.0015	CHROMEplus Combination spanner, stubby, 15 mm	1
9	517.0268	Open double ring spanner, offset, 24 x 27 mm	1	21	517.0305	Double revolving head spanner, 16 x 17 mm	1				
10	517.0266	Open double ring spanner, offset, 19 x 22 mm	1	22	517.0306	Double revolving head spanner, 18 x 19 mm	1				
11	517.0264	Open double ring spanner, offset, 17 x 19 mm	1	23	920.0418	ULTIMATEplus Double ring ended spanner, 18 x 19 mm	1				
12	517.0263	Open double ring spanner, offset, 16 x 18 mm	1	24	920.0416	ULTIMATEplus Double ring ended spanner, 16 x 17 mm	1				

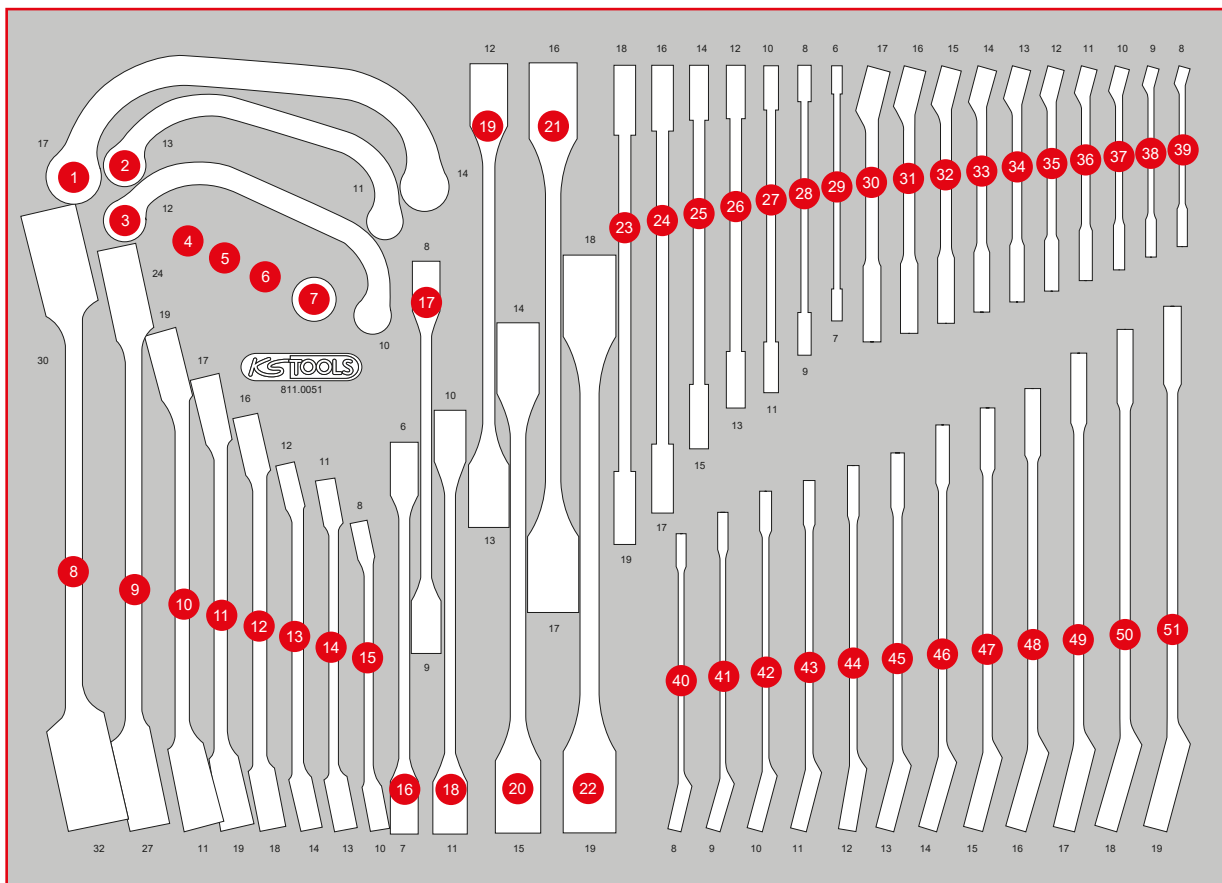

Pos.	Code	Description	pcs	Pos.	Code	Description	pcs	Pos.	Code	Description	pcs
33	518.0014	CHROMEplus Combination spanner, stubby, 14 mm	1	41	503.4609	GEARplus reversing combination ratcheting spanner, 9 mm	1	48	503.4616	GEARplus reversing combination ratcheting spanner, 16 mm	1
34	518.0013	CHROMEplus Combination spanner, stubby, 13 mm	1	42	503.4610	GEARplus reversing combination ratcheting spanner, 10 mm	1	49	503.4617	GEARplus reversing combination ratcheting spanner, 17 mm	1
35	518.0012	CHROMEplus Combination spanner, stubby, 12 mm	1	43	503.4611	GEARplus reversing combination ratcheting spanner, 11 mm	1	50	503.4618	GEARplus reversing combination ratcheting spanner, 18 mm	1
36	518.0011	CHROMEplus Combination spanner, stubby, 11 mm	1	44	503.4612	GEARplus reversing combination ratcheting spanner, 12 mm	1	51	503.4619	GEARplus reversing combination ratcheting spanner, 19 mm	1
37	518.0010	CHROMEplus Combination spanner, stubby, 10 mm	1	45	503.4613	GEARplus reversing combination ratcheting spanner, 13 mm	1				
38	518.0008	CHROMEplus Combination spanner, stubby, 9 mm	1	46	503.4614	GEARplus reversing combination ratcheting spanner, 14 mm	1				
39	518.0007	CHROMEplus Combination spanner, stubby, 8 mm	1	47	503.4615	GEARplus reversing combination ratcheting spanner, 15 mm	1				
40	503.4608	GEARplus reversing combination ratcheting spanner, 8 mm	1								

811.0033

M Pliers, Hammer and chisel set

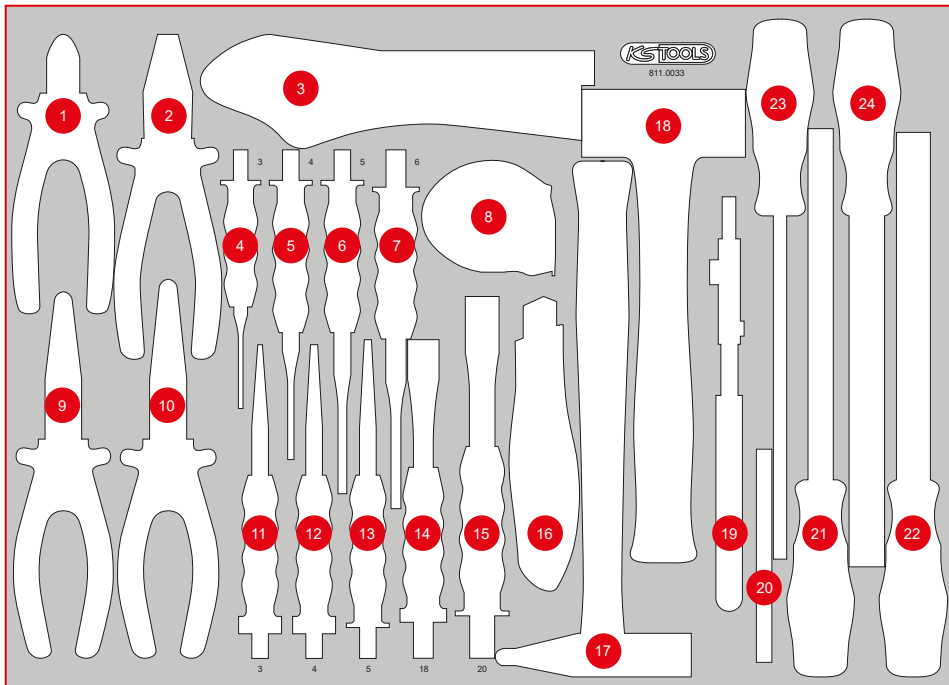

Pos.	Code	Description	pcs
1	115.1012	ERGOTORQUE diagonal side cutter, 160 mm	1
2	115.1021	ERGOTORQUE combination pliers, 180 mm	1
3	115.1033	Self grip wrench, 220 mm	1
4	156.0231	Pin punch, Ø 3 mm, cylindrical shaft	1
5	156.0232	Pin punch, Ø 4 mm, cylindrical shaft	1
6	156.0233	Pin punch, Ø 5 mm, cylindrical shaft	1
7	156.0234	Pin punch, Ø 6 mm, cylindrical shaft	1
8	300.0114	Tape measure with locking device and belt clip, black red, 5 m, 19 mm	1
9	115.1019	ERGOTORQUE bent nose pliers serrated, 210 mm	1
10	115.1024	ERGOTORQUE long nose pliers serrated cutter, 200 mm	1
11	156.0237	Punch, Ø 3 mm, conical	1
12	156.0238	Punch, Ø 4 mm, conical	1
13	156.0244	Punch, Ø 5 mm, conical	1
14	156.0254	Flat chisel, octagon, 18 mm	1
15	156.0241	Flat chisel, octagon, 20 mm	1
16	907.2135	Universal snap off blade knife 18 mm	1
17	142.1402	Fitters Hammer, fibreglas handle, 400 g	1
18	142.5101	Club Hammer, fibreglas handle, 1000 g	1
19	115.2010	Water pump pliers, 240 mm	1
20	907.2166	Snap off blades 0,5 x 1,8 x 100 mm, dispenser with 10 pieces	10
21	157.0405	Tri-bastard file, form C, cut 2, 200 mm	1
22	157.0105	Halfround file, form E, cut 2, 20 mm	1
23	157.0205	Round file, form F, cut 2, 200 mm	1
24	157.0005	Flat file, form B, cut 2, 200 mm	1

P10

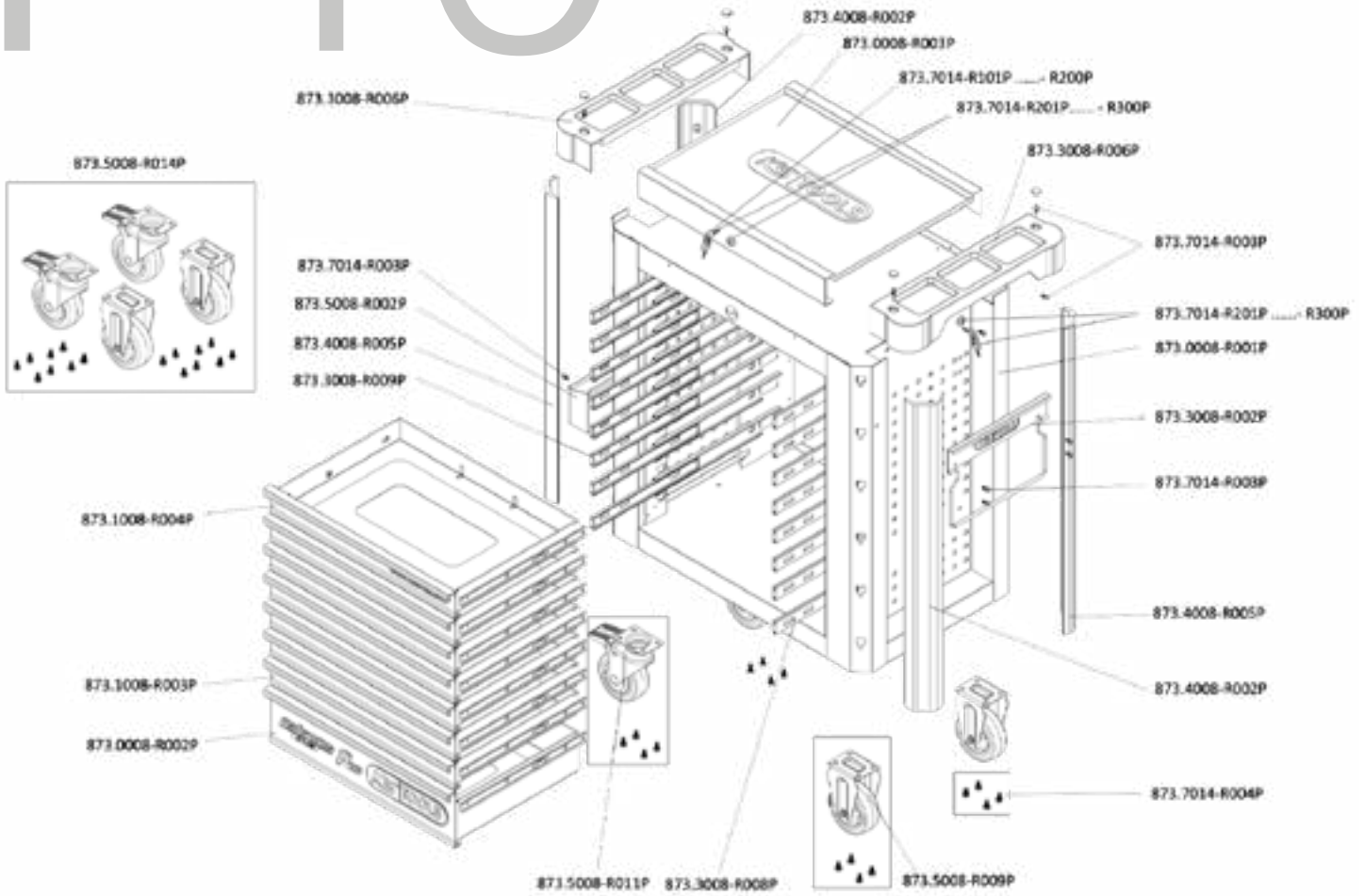

INDIVIDUAL PARTS LIST

Item No.	Description	Amount
873.7014-R101P...	Replacement key for PERFORMANCEplus workshop trolley lock number xyz	2
873.7014-R201P...	Lock with 2 keys for PERFORMANCEplus workshop trolley lock number xyz	2
873.0008-R001P	Body with handle	1
873.0008-R002P	Compartment with logo and ball-bearing guide, 568x398x145 mm	1
873.0008-R003P	Stainless steel worktop	1
873.1008-R003P	Compartment with ball-bearing guide, for workshop trolley P10/P10TC/P15, 568x398x65 mm	6
873.1008-R004P	Compartment with website and ball-bearing guide, for workshop trolley P10/P15, 568x398x65 mm	1
873.3008-R002P	Paper roll holder for PERFORMANCEplus workshop trolley	1
873.3008-R006P	Storage for work surface	2
873.3008-R008P	Full extension (with ball-bearing guide) with automatic retraction	8
873.3008-R009P	Full extension (with ball-bearing guide) with automatic retraction	8
873.4008-R002P	Plastic bumpers	2
873.4008-R005P	Plastic bumpers	2
873.5008-R002P	Can holder for PERFORMANCEplus workshop trolley	1
873.5008-R009P	Fixed castors for PERFORMANCEplus workshop trolley, incl. screws	2
873.5008-R011P	Swivel castors with brakes, for PERFORMANCEplus workshop trolley, incl. screws	2
873.5008-R014P	Roller set for PERFORMANCEplus workshop trolley, incl. screws	1
873.7014-R003P	M6x12 screws for PERFORMANCEplus workshop trolley accessories	14
873.7014-R004P	M8 screws for PERFORMANCEplus workshop trolley rollers (16 pcs.)	1



873.7014-R101P...R200P
Replacement key for lock number xyz



873.7014-R201P...R300P
Lock with 2 keys for lock number xyz



873.3008-R008P
Full extension (with ball-bearing guide) with automatic retraction, right



873.3008-R009P
Full extension (with ball-bearing guide) with automatic retraction, left



873.5008-R009P
Fixed castors, incl. screws



873.5008-R011P
Swivel castors with brakes, incl. screws

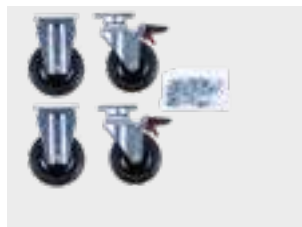

873.5008-R014P
Roller set, incl. screws



873.0008-R003P
Stainless steel work surface



873.3008-R006P
Storage for work surface, including screw cover, usable on both sides



873.1008-R004P
Compartment with website and ball-bearing guide, 568x398x65 mm



873.1008-R003P
Compartment with ball-bearing guide, 568x398x65 mm



873.0008-R002P
Compartment with logo and ball-bearing guide, 568x398x145 mm



873.5008-R002P
Can holder, 310 mm



873.3008-R002P
Paper roll holder, 320 mm



873.4008-R005P
Plastic bumpers, front left, back right



873.4008-R002P
Plastic bumpers, front right, back left



873.7014-R004P
M8 screws (16 pcs.)



873.7014-R003P
M6x12 screw (1 pcs.)



873.0008-R001P
Body with handle



A thousand great parts for tough guys!

