

P10

workshop tool trolley
with 423 tools for 6 drawers
810.6423

Workshop trolley P10

with 8 compartments

873.0008

THE ENTRY MODEL TO SATISFY HIGH STANDARDS



P10



DUO Lock Brilliant locking system



Eight drawers each load capacity up to 50 kg



Stable **ball bearing**



Stainless steel surface



Lock lockable



Anti-static castors with brakes



Integrated **corner protection**



Paper roll holder included



Can holder included

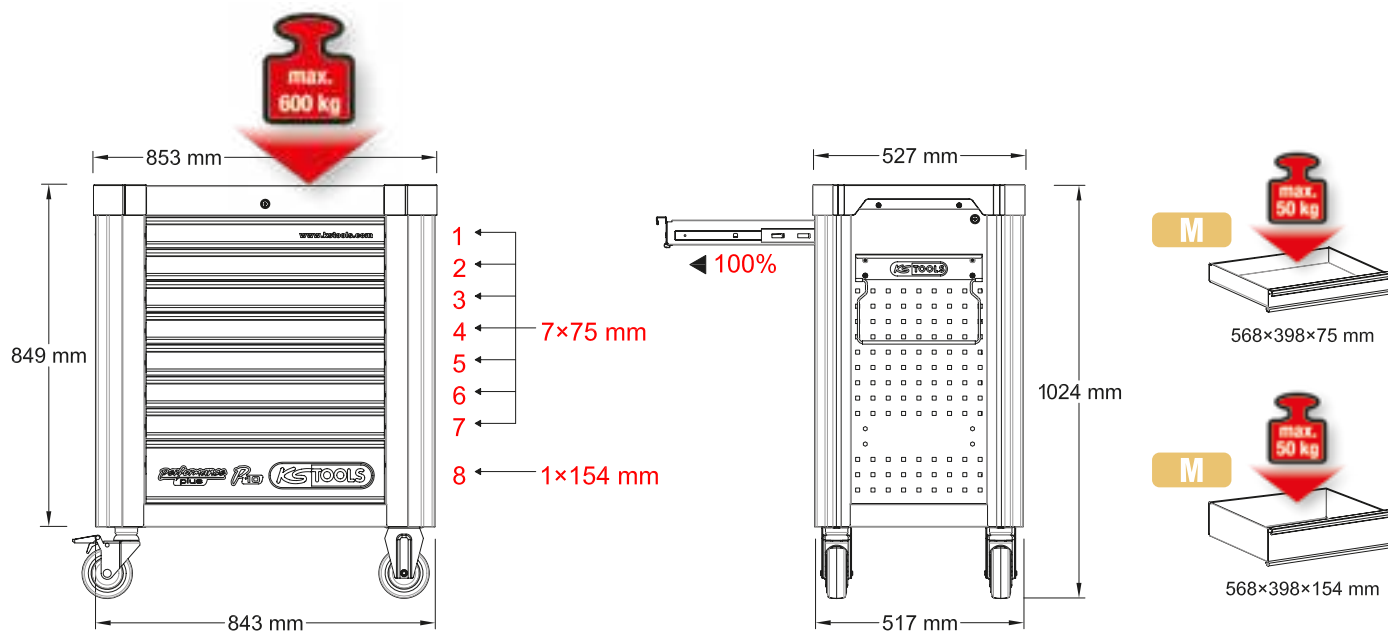

P10 workshop tool trolley set with 423 tools for 6 drawers

810.6423



M

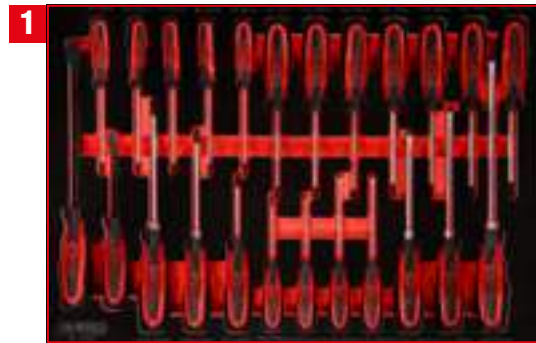

Screwdriver set in foam insert

811.0024

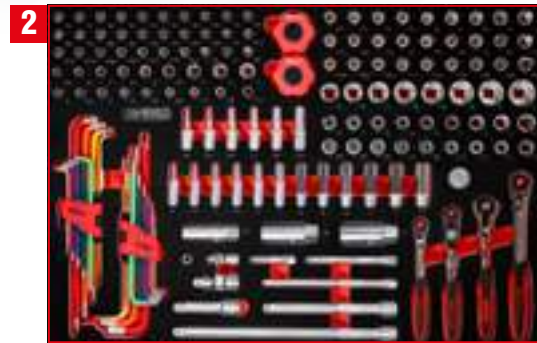

1/4\"/>

811.0156

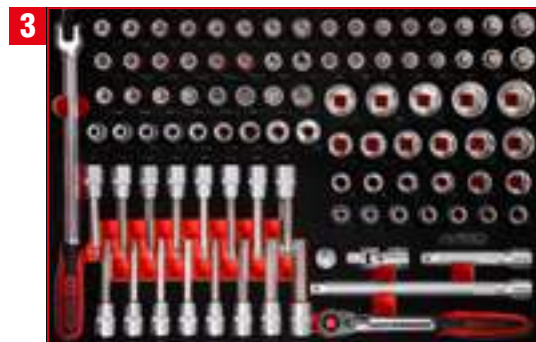

1/2\"/>

811.0095



Screw spanner set in foam insert

811.0053



3/8\"/>

811.0073



Pliers, hammer and chisel set in foam insert

811.2022

811.0024

M Screwdriver set

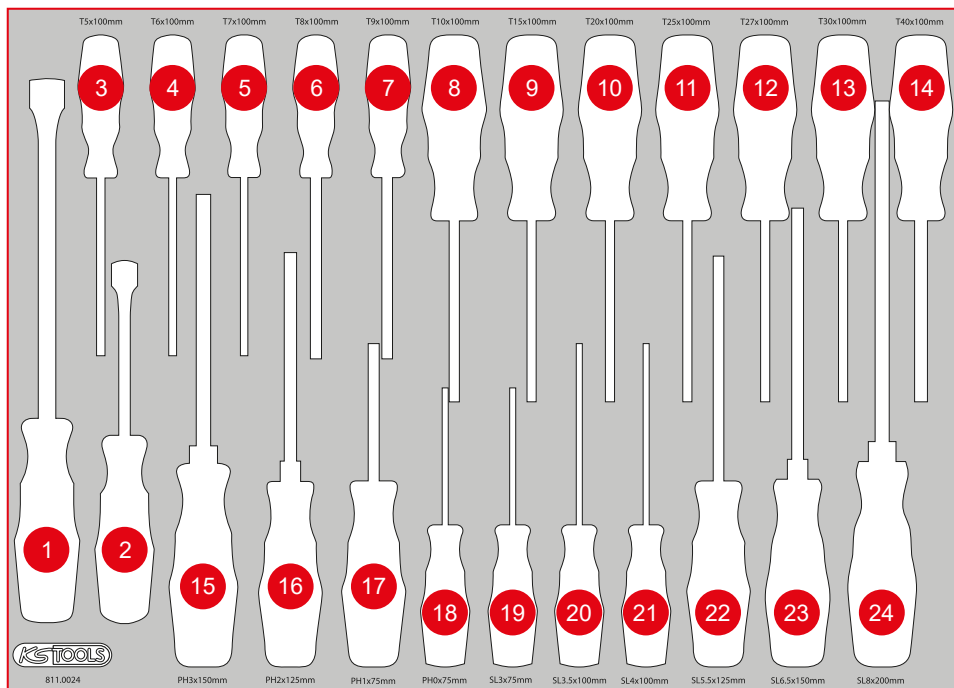
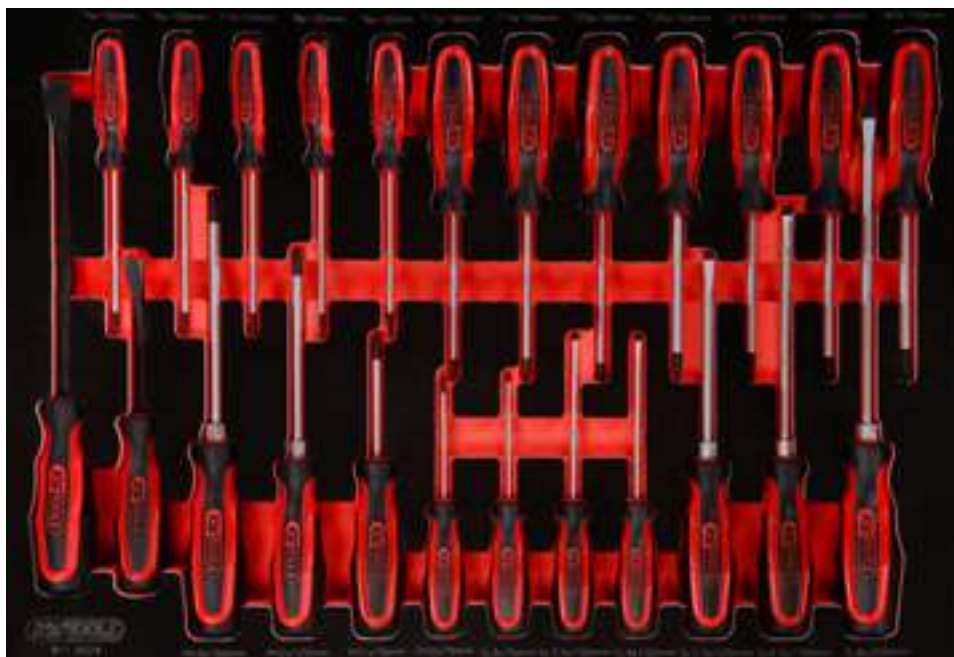

| Pos. | Code | Description | pcs |
|------|----------|---|-----|
| 1 | 911.8102 | Pry bar, 15 x 185 mm | 1 |
| 2 | 911.8101 | Pry bar, 11 x 115 mm | 1 |
| 3 | 159.1133 | ERGOTORQUEplus screwdriver, Torx, T5 | 1 |
| 4 | 159.1134 | ERGOTORQUEplus screwdriver, Torx, T6 | 1 |
| 5 | 159.1135 | ERGOTORQUEplus screwdriver, Torx, T7 | 1 |
| 6 | 159.1030 | ERGOTORQUEplus screwdriver, Torx, T8 | 1 |
| 7 | 159.1031 | ERGOTORQUEplus screwdriver, Torx, T9 | 1 |
| 8 | 159.1032 | ERGOTORQUEplus screwdriver, Torx, T10 | 1 |
| 9 | 159.1033 | ERGOTORQUEplus screwdriver, Torx, T15 | 1 |
| 10 | 159.1034 | ERGOTORQUEplus screwdriver, Torx, T20 | 1 |
| 11 | 159.1035 | ERGOTORQUEplus screwdriver, Torx, T25 | 1 |
| 12 | 159.1036 | ERGOTORQUEplus screwdriver, Torx, T27 | 1 |
| 13 | 159.1037 | ERGOTORQUEplus screwdriver, Torx, T30 | 1 |
| 14 | 159.1038 | ERGOTORQUEplus screwdriver, Torx, T40 | 1 |
| 15 | 159.1024 | ERGOTORQUEplus screwdriver, Torx, PH3, 265 mm | 1 |
| 16 | 159.1022 | ERGOTORQUEplus screwdriver, Torx, PH2, 230 mm | 1 |
| 17 | 159.1020 | ERGOTORQUEplus screwdriver, Torx, PH1, 180 mm | 1 |
| 18 | 159.1027 | ERGOTORQUEplus screwdriver, Torx, PH0, 155 mm | 1 |
| 19 | 159.1002 | ERGOTORQUEplus screwdriver for slotted screws, 3 mm, 155 mm | 1 |
| 20 | 159.1112 | ERGOTORQUEplus screwdriver for slotted screws, 3,5 mm, 180 mm | 1 |
| 21 | 159.1004 | ERGOTORQUEplus screwdriver for slotted screws, 4 mm, 180 mm | 1 |
| 22 | 159.1006 | ERGOTORQUEplus screwdriver for slotted screws, 5,5 mm, 230 mm | 1 |
| 23 | 159.1009 | ERGOTORQUEplus screwdriver for slotted screws, 6,5 mm, 255 mm | 1 |
| 24 | 159.1011 | ERGOTORQUEplus screwdriver for slotted screws, 8 mm, 315 mm | 1 |

M 1/4" + 3/8" socket spanner set

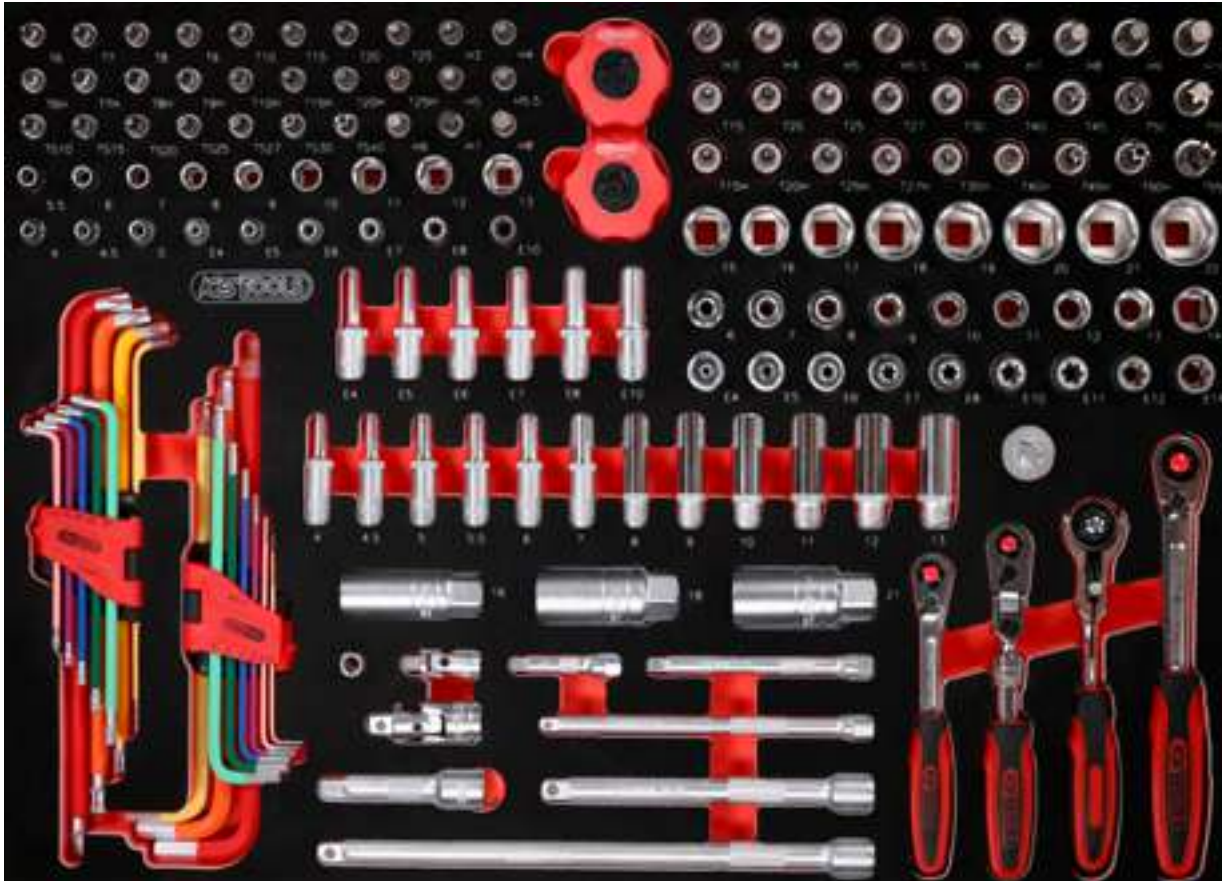

| Pos. | Code | Description | pcs | Pos. | Code | Description | pcs | Pos. | Code | Description | pcs |
|------|----------|---|-----|------|-----------|-------------------------------------|-----|------|----------|--|-----|
| 1 | 920.3890 | 3/8" SlimPOWER Reversible ratchet, 72 teeth | 1 | 22 | 917.1527 | 1/4" Hexagonal socket, deep, 5 mm | 1 | 46 | 917.1410 | 1/4" Hexagonal socket, 10 mm | 1 |
| 2 | 914.1405 | 1/4" MODIFIX mini T-handle swivel head ratchet, 72 teeth | 1 | 23 | 917.1528 | 1/4" Hexagonal socket, deep, 5,5 mm | 1 | 47 | 917.1411 | 1/4" Hexagonal socket, 11 mm | 1 |
| 3 | 914.1420 | 1/4" SlimPOWER telescopic-joint reversible ratchet, 72 teeth | 1 | 24 | 917.1426 | 1/4" Hexagonal socket, deep, 6 mm | 1 | 48 | 917.1412 | 1/4" Hexagonal socket, 12 mm | 1 |
| 4 | 920.1490 | 1/4" SlimPOWER Reversible ratchet, 72 teeth | 1 | 25 | 917.1427 | 1/4" Hexagonal socket, deep, 7 mm | 1 | 49 | 917.1413 | 1/4" Hexagonal socket, 13 mm | 1 |
| 5 | 911.1423 | 1/4" Extension with hexagon drive, 50 mm | 1 | 26 | 917.1428 | 1/4" Hexagonal socket, deep, 8 mm | 1 | 50 | 911.4313 | 1/4" Torx E Socket, E4 | 1 |
| 6 | 911.1424 | 1/4" Extension with hexagon drive, 100 mm | 1 | 27 | 917.1429 | 1/4" Hexagonal socket, deep, 9 mm | 1 | 51 | 911.4314 | 1/4" Torx E Socket, E5 | 1 |
| 7 | 911.1451 | 1/4" Extension with hexagon drive, 150 mm | 1 | 28 | 917.1430 | 1/4" Hexagonal socket, deep, 10 mm | 1 | 52 | 911.4315 | 1/4" Torx E Socket, E6 | 1 |
| 8 | 911.3801 | 3/8" Extension with knurling, 75 mm | 1 | 29 | 917.1431 | 1/4" Hexagonal socket, deep, 11 mm | 1 | 53 | 911.4316 | 1/4" Torx E Socket, E7 | 1 |
| 9 | 911.3802 | 3/8" Extension with knurling, 150 mm | 1 | 30 | 917.1432 | 1/4" Hexagonal socket, deep, 12 mm | 1 | 54 | 911.4317 | 1/4" Torx E Socket, E8 | 1 |
| 10 | 911.3803 | 3/8" Extension with knurling, 250 mm | 1 | 31 | 917.1433 | 1/4" Hexagonal socket, deep, 13 mm | 1 | 55 | 911.4332 | 1/4" Torx E Socket, E10 | 1 |
| 11 | 911.1450 | 1/4" Universal joint | 1 | 32 | 917.2401 | 1/4" Torx E Socket, deep, E4 | 1 | 56 | 911.4407 | 1/4" Bit socket Torx, T6 | 1 |
| 12 | 911.3850 | 3/8" Universal joint | 1 | 33 | 917.2402 | 1/4" Torx E Socket, deep, E5 | 1 | 57 | 911.4362 | 1/4" Bit socket Torx, T7 | 1 |
| 13 | 911.0101 | 1/4" socket with magnet | 1 | 34 | 917.2403 | 1/4" Torx E Socket, deep, E6 | 1 | 58 | 911.1448 | 1/4" Bit socket Torx, T8 | 1 |
| 14 | 911.3804 | 3/8" Spark plug socket, 16 mm | 1 | 35 | 917.2404 | 1/4" Torx E Socket, deep, E7 | 1 | 59 | 911.1478 | 1/4" Bit socket Torx, T9 | 1 |
| 15 | 911.3823 | 3/8" Spark plug socket, 18 mm | 1 | 36 | 917.2405 | 1/4" Torx E Socket, deep, E8 | 1 | 60 | 911.1442 | 1/4" Bit socket Torx, T10 | 1 |
| 16 | 911.3805 | 3/8" Spark plug socket, 21 mm | 1 | 37 | 917.2406 | 1/4" Torx E Socket, deep, E10 | 1 | 61 | 911.1443 | 1/4" Bit socket Torx, T15 | 1 |
| 17 | 911.3826 | 3/8" Sliding / reducing adaptor, 1/2" F x 3/8" M | 1 | 38 | 917.1404 | 1/4" Hexagonal socket, 4 mm | 1 | 62 | 911.1444 | 1/4" Bit socket Torx, T20 | 1 |
| 18 | 151.4530 | Ball ended Torx key wrench set, extra long and bent 108°, 9 pcs | 9 | 39 | 917.14045 | 1/4" Hexagonal socket, 4,5 mm | 1 | 63 | 911.1445 | 1/4" Bit socket Torx, T25 | 1 |
| 19 | 151.4420 | Ball ended hexagon key wrench set, extra long, 9 pcs | 9 | 40 | 917.1405 | 1/4" Hexagonal socket, 5 mm | 1 | 64 | 917.1456 | 1/4" Bit socket Torx tamperproof, TB6 | 1 |
| 20 | 917.1525 | 1/4" Hexagonal socket, deep, 4 mm | 1 | 41 | 917.14055 | 1/4" Hexagonal socket, 5,5 mm | 1 | 65 | 917.1457 | 1/4" Bit socket Torx tamperproof, TB7 | 1 |
| 21 | 917.1526 | 1/4" Hexagonal socket, deep, 4,5 mm | 1 | 42 | 917.1406 | 1/4" Hexagonal socket, 6 mm | 1 | 66 | 911.1461 | 1/4" Bit socket Torx tamperproof, TB8 | 1 |
| | | | | 43 | 917.1407 | 1/4" Hexagonal socket, 7 mm | 1 | 67 | 911.1485 | 1/4" Bit socket Torx tamperproof, TB9 | 1 |
| | | | | 44 | 917.1408 | 1/4" Hexagonal socket, 8 mm | 1 | 68 | 911.1462 | 1/4" Bit socket Torx tamperproof, TB10 | 1 |
| | | | | 45 | 917.1409 | 1/4" Hexagonal socket, 9 mm | 1 | 69 | 911.1463 | 1/4" Bit socket Torx tamperproof, TB15 | 1 |

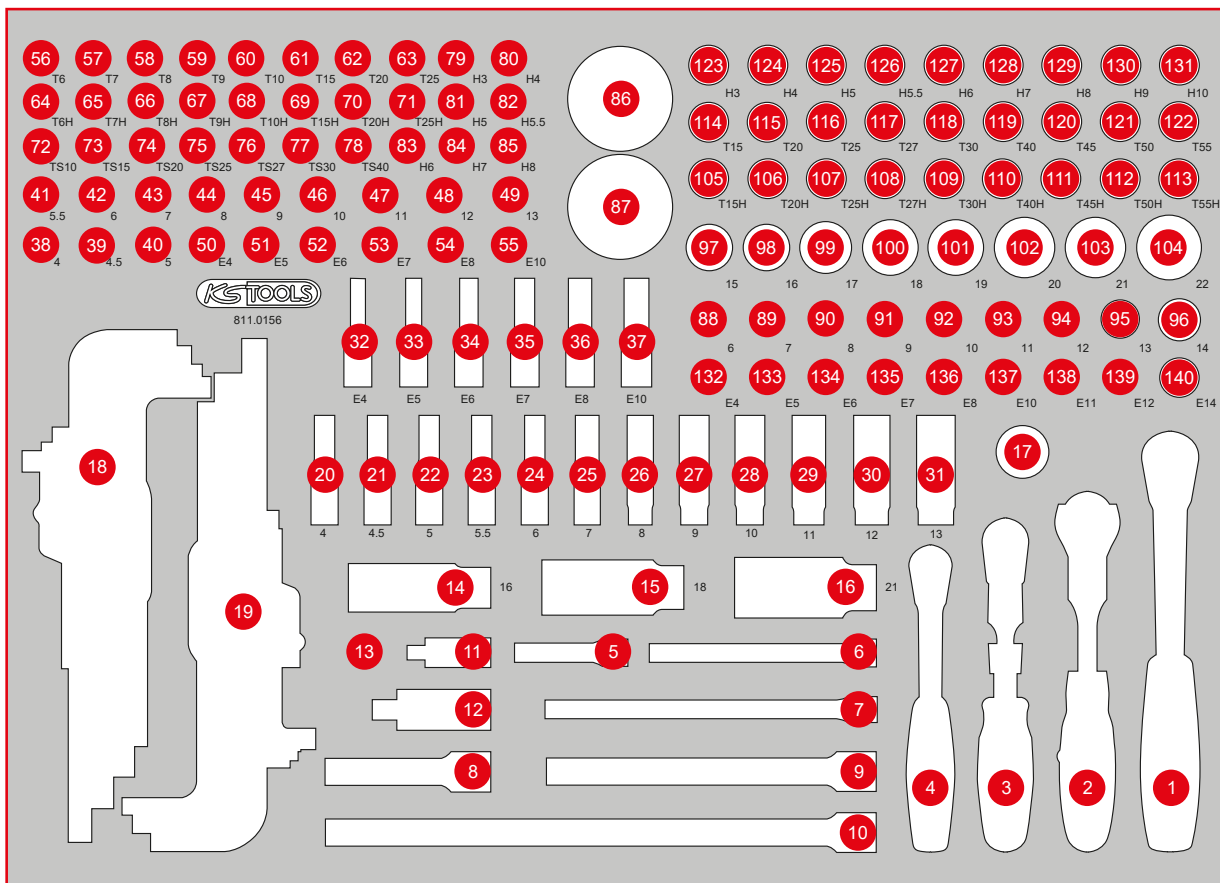

| Pos. | Code | Description | pcs | Pos. | Code | Description | pcs | Pos. | Code | Description | pcs |
|------|-----------|---|-----|------|----------|--|-----|------|-----------|---------------------------------|-----|
| 70 | 911.1464 | 1/4" Bit socket Torx tamperproof, TB20 | 1 | 94 | 917.3812 | 3/8" Hexagonal socket, 12 mm | 1 | 118 | 911.3873 | 3/8" Bit socket Torx, T30 | 1 |
| 71 | 911.1465 | 1/4" Bit socket Torx tamperproof, TB25 | 1 | 95 | 917.3813 | 3/8" Hexagonal socket, 13 mm | 1 | 119 | 911.3874 | 3/8" Bit socket Torx, T40 | 1 |
| 72 | 911.1701 | 1/4" Bit socket five star tamperproof, TS10 | 1 | 96 | 917.3814 | 3/8" Hexagonal socket, 14 mm | 1 | 120 | 911.3885 | 3/8" Bit socket Torx, T45 | 1 |
| 73 | 911.1702 | 1/4" Bit socket five star tamperproof, TS15 | 1 | 97 | 917.3815 | 3/8" Hexagonal socket, 15 mm | 1 | 121 | 911.3884 | 3/8" Bit socket Torx, T50 | 1 |
| 74 | 911.1703 | 1/4" Bit socket five star tamperproof, TS20 | 1 | 98 | 917.3816 | 3/8" Hexagonal socket, 16 mm | 1 | 122 | 911.3888 | 3/8" Bit socket Torx, T55 | 1 |
| 75 | 911.1704 | 1/4" Bit socket five star tamperproof, TS25 | 1 | 99 | 917.3817 | 3/8" Hexagonal socket, 17 mm | 1 | 123 | 911.3863 | 3/8" Bit socket hexagon, 3 mm | 1 |
| 76 | 911.1705 | 1/4" Bit socket five star tamperproof, TS27 | 1 | 100 | 917.3818 | 3/8" Hexagonal socket, 18 mm | 1 | 124 | 911.3864 | 3/8" Bit socket hexagon, 4 mm | 1 |
| 77 | 911.1706 | 1/4" Bit socket five star tamperproof, TS30 | 1 | 101 | 917.3819 | 3/8" Hexagonal socket, 19 mm | 1 | 125 | 911.3865 | 3/8" Bit socket hexagon, 5 mm | 1 |
| 78 | 911.1707 | 1/4" Bit socket five star tamperproof, TS40 | 1 | 102 | 917.3820 | 3/8" Hexagonal socket, 20 mm | 1 | 126 | 911.38655 | 3/8" Bit socket hexagon, 5.5 mm | 1 |
| 79 | 911.1436 | 1/4" Bit socket hexagon, 3 mm | 1 | 103 | 917.3821 | 3/8" Hexagonal socket, 21 mm | 1 | 127 | 911.3866 | 3/8" Bit socket hexagon, 6 mm | 1 |
| 80 | 911.1437 | 1/4" Bit socket hexagon, 4 mm | 1 | 104 | 917.3822 | 3/8" Hexagonal socket, 22 mm | 1 | 128 | 911.3867 | 3/8" Bit socket hexagon, 7 mm | 1 |
| 81 | 911.1438 | 1/4" Bit socket hexagon, 5 mm | 1 | 105 | 911.3961 | 3/8" Bit socket Torx tamperproof, TB15 | 1 | 129 | 911.3868 | 3/8" Bit socket hexagon, 8 mm | 1 |
| 82 | 911.14385 | 1/4" Bit socket hexagon, 5.5 mm | 1 | 106 | 911.3962 | 3/8" Bit socket Torx tamperproof, TB20 | 1 | 130 | 917.3969 | 3/8" Bit socket hexagon, 9 mm | 1 |
| 83 | 911.1439 | 1/4" Bit socket hexagon, 6 mm | 1 | 107 | 911.3963 | 3/8" Bit socket Torx tamperproof, TB25 | 1 | 131 | 917.3857 | 3/8" Bit socket hexagon, 10 mm | 1 |
| 84 | 911.1440 | 1/4" Bit socket hexagon, 7 mm | 1 | 108 | 911.3964 | 3/8" Bit socket Torx tamperproof, TB27 | 1 | 132 | 911.4338 | 3/8" Torx E Socket, E4 | 1 |
| 85 | 911.1441 | 1/4" Bit socket hexagon, 8 mm | 1 | 109 | 911.3965 | 3/8" Bit socket Torx tamperproof, TB30 | 1 | 133 | 911.4339 | 3/8" Torx E Socket, E5 | 1 |
| 86 | 914.1410 | Mini hand reversible ratchet, 1/4", 72 teethh | 1 | 110 | 911.3966 | 3/8" Bit socket Torx tamperproof, TB40 | 1 | 134 | 911.4340 | 3/8" Torx E Socket, E6 | 1 |
| 87 | 914.3810 | Mini hand reversible ratchet, 3/8", 72 teethh | 1 | 111 | 911.3967 | 3/8" Bit socket Torx tamperproof, TB45 | 1 | 135 | 911.4341 | 3/8" Torx E Socket, E7 | 1 |
| 88 | 917.3806 | 3/8" Hexagonal socket, 6 mm | 1 | 112 | 911.3968 | 3/8" Bit socket Torx tamperproof, TB50 | 1 | 136 | 911.4342 | 3/8" Torx E Socket, E8 | 1 |
| 89 | 917.3807 | 3/8" Hexagonal socket, 7 mm | 1 | 113 | 911.3969 | 3/8" Bit socket Torx tamperproof, TB55 | 1 | 137 | 911.4318 | 3/8" Torx E Socket, E10 | 1 |
| 90 | 917.3808 | 3/8" Hexagonal socket, 8 mm | 1 | 114 | 911.3869 | 3/8" Bit socket Torx, T15 | 1 | 138 | 911.4319 | 3/8" Torx E Socket, E11 | 1 |
| 91 | 917.3809 | 3/8" Hexagonal socket, 9 mm | 1 | 115 | 911.3870 | 3/8" Bit socket Torx, T20 | 1 | 139 | 911.4320 | 3/8" Torx E Socket, E12 | 1 |
| 92 | 917.3810 | 3/8" Hexagonal socket, 10 mm | 1 | 116 | 911.3871 | 3/8" Bit socket Torx, T25 | 1 | 140 | 911.4321 | 3/8" Torx E Socket, E14 | 1 |
| 93 | 917.3811 | 3/8" Hexagonal socket, 11 mm | 1 | 117 | 911.3872 | 3/8" Bit socket Torx, T27 | 1 | | | | |

811.0095

M 1/2" Socket spanner set

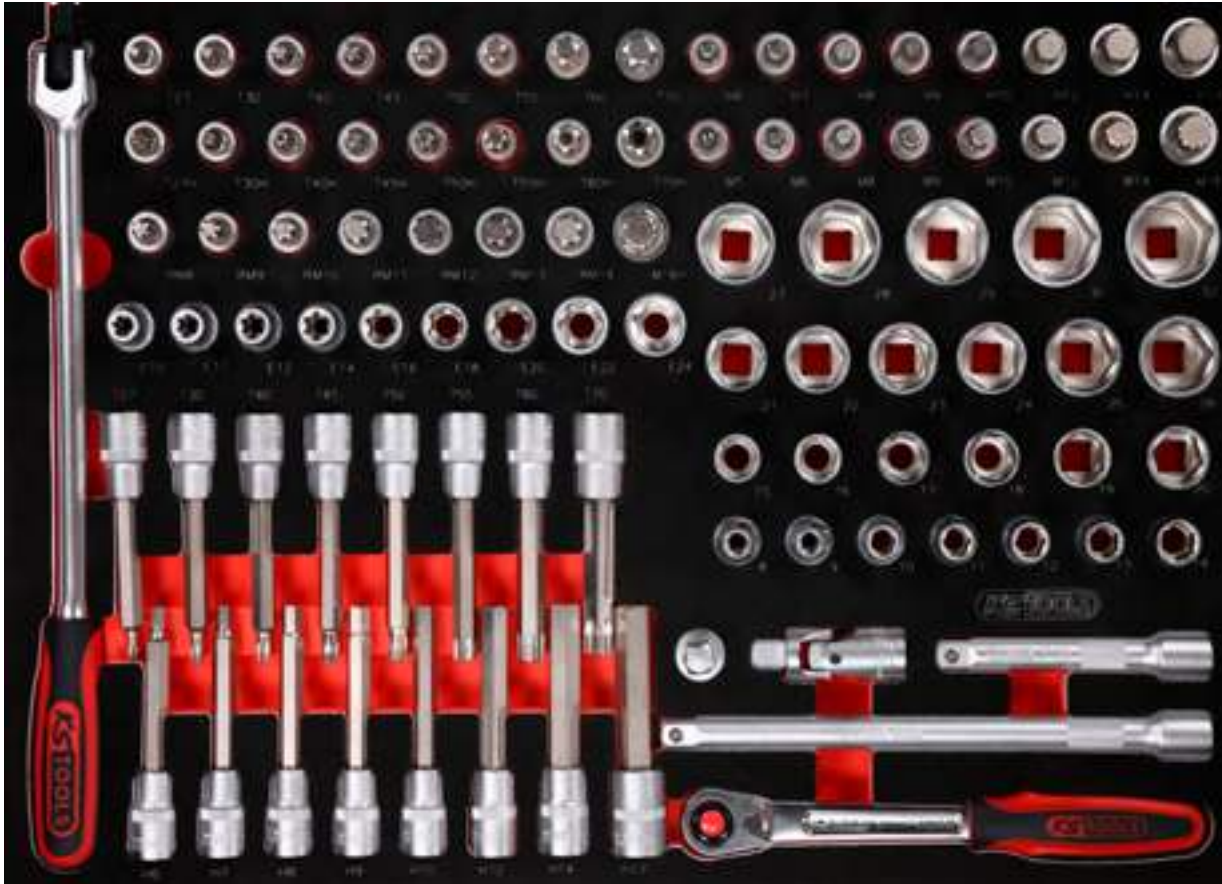

| Pos. | Code | Description | pcs | Pos. | Code | Description | pcs | Pos. | Code | Description | pcs |
|------|----------|---------------------------------------|-----|------|----------|--|-----|------|----------|--|-----|
| 1 | 917.1455 | 1/2" Flexi head drive handle | 1 | 18 | 911.1373 | 1/2" Bit socket Torx tamperproof, TB27 | 1 | 35 | 911.4515 | Bit socket for RIBE screws, M9, length 55 mm | 1 |
| 2 | 911.1363 | 1/2" Bit socket Torx, T27 | 1 | 19 | 911.1374 | 1/2" Bit socket Torx tamperproof, TB30 | 1 | 36 | 911.4516 | Bit socket for RIBE screws, M10, length 55 mm | 1 |
| 3 | 911.1364 | 1/2" Bit socket Torx, T30 | 1 | 20 | 911.1375 | 1/2" Bit socket Torx tamperproof, TB40 | 1 | 37 | 911.4551 | Bit socket for RIBE screws, M10.1, length 55 mm | 1 |
| 4 | 911.1365 | 1/2" Bit socket Torx, T40 | 1 | 21 | 911.1376 | 1/2" Bit socket Torx tamperproof, TB45 | 1 | 38 | 911.4517 | Bit socket for RIBE screws, M12, length 55 mm | 1 |
| 5 | 911.1366 | 1/2" Bit socket Torx, T45 | 1 | 22 | 911.1377 | 1/2" Bit socket Torx tamperproof, TB50 | 1 | 39 | 911.4518 | Bit socket for RIBE screws, M13, length 55 mm | 1 |
| 6 | 911.1367 | 1/2" Bit socket Torx, T50 | 1 | 23 | 911.1378 | 1/2" Bit socket Torx tamperproof, TB55 | 1 | 40 | 911.4519 | Bit socket for RIBE screws, M14, length 55 mm | 1 |
| 7 | 911.1368 | 1/2" Bit socket Torx, T55 | 1 | 24 | 911.1379 | 1/2" Bit socket Torx tamperproof, TB60 | 1 | 41 | 911.1348 | 1/2" Bit socket spline (XZN) tamperproof, M16, 55 mm | 1 |
| 8 | 911.1369 | 1/2" Bit socket Torx, T60 | 1 | 25 | 911.1380 | 1/2" Bit socket Torx tamperproof, TB70 | 1 | 42 | 917.1227 | 1/2" Hexagonal socket, 27 mm | 1 |
| 9 | 911.1370 | 1/2" Bit socket Torx, T70 | 1 | 26 | 911.1340 | 1/2" Bit socket spline (XZN), M5, 55 mm | 1 | 43 | 917.1344 | 1/2" Hexagonal socket, 28 mm | 1 |
| 10 | 911.1306 | 1/2" Bit socket hexagon, short, 6 mm | 1 | 27 | 911.1341 | 1/2" Bit socket spline (XZN), M6, 55 mm | 1 | 44 | 917.1345 | 1/2" Hexagonal socket, 29 mm | 1 |
| 11 | 911.1307 | 1/2" Bit socket hexagon, short, 7 mm | 1 | 28 | 911.1342 | 1/2" Bit socket spline (XZN), M8, 55 mm | 1 | 45 | 917.1230 | 1/2" Hexagonal socket, 30 mm | 1 |
| 12 | 911.1308 | 1/2" Bit socket hexagon, short, 8 mm | 1 | 29 | 911.1313 | 1/2" Bit socket spline (XZN), M9, 55 mm | 1 | 46 | 917.1232 | 1/2" Hexagonal socket, 32 mm | 1 |
| 13 | 911.1309 | 1/2" Bit socket hexagon, short, 9 mm | 1 | 30 | 911.1343 | 1/2" Bit socket spline (XZN), M10, 55 mm | 1 | 47 | 911.4333 | 1/2" Torx E Socket, E10 | 1 |
| 14 | 911.1310 | 1/2" Bit socket hexagon, short, 10 mm | 1 | 31 | 911.1344 | 1/2" Bit socket spline (XZN), M12, 55 mm | 1 | 48 | 911.4334 | 1/2" Torx E Socket, E11 | 1 |
| 15 | 911.1312 | 1/2" Bit socket hexagon, short, 12 mm | 1 | 32 | 911.1345 | 1/2" Bit socket spline (XZN), M14, 55 mm | 1 | 49 | 911.4335 | 1/2" Torx E Socket, E12 | 1 |
| 16 | 911.1314 | 1/2" Bit socket hexagon, short, 14 mm | 1 | 33 | 911.1346 | 1/2" Bit socket spline (XZN), M16, 55 mm | 1 | 50 | 911.4336 | 1/2" Torx E Socket, E14 | 1 |
| 17 | 911.1317 | 1/2" Bit socket hexagon, short, 17 mm | 1 | 34 | 911.4514 | Bit socket for RIBE screws, M8, length 55 mm | 1 | | | | |

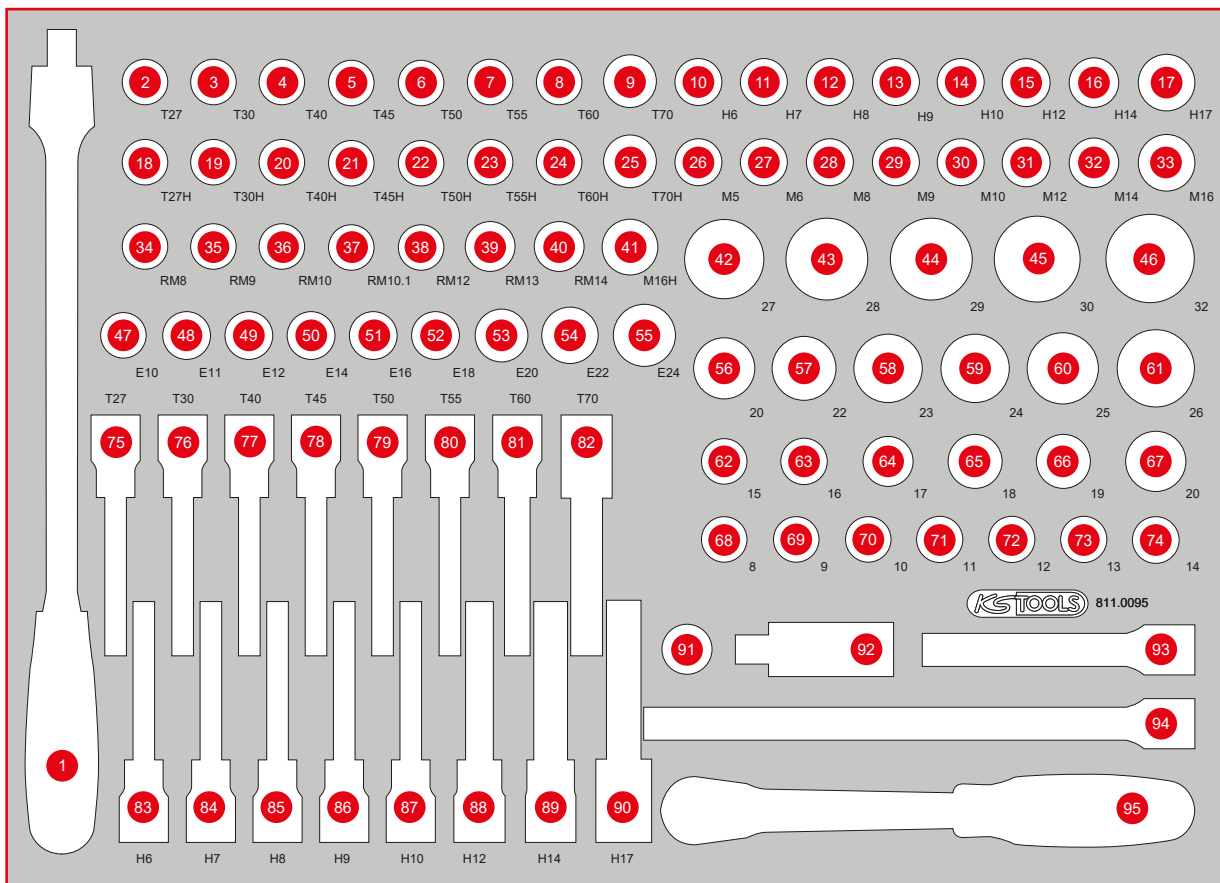

| Pos. | Code | Description | pcs | Pos. | Code | Description | pcs | Pos. | Code | Description | pcs |
|------|----------|------------------------------|-----|------|----------|--------------------------------------|-----|------|----------|---|-----|
| 51 | 911.4322 | 1/2" Torx E Socket, E16 | 1 | 68 | 917.1340 | 1/2" Hexagonal socket, 8 mm | 1 | 77 | 911.1525 | 1/2" Bit socket Torx, long, T40 | 1 |
| 52 | 911.4323 | 1/2" Torx E Socket, E18 | 1 | 69 | 917.1341 | 1/2" Hexagonal socket, 9 mm | 1 | 78 | 911.1526 | 1/2" Bit socket Torx, long, T45 | 1 |
| 53 | 911.4324 | 1/2" Torx E Socket, E20 | 1 | 70 | 917.1210 | 1/2" Hexagonal socket, 10 mm | 1 | 79 | 911.1527 | 1/2" Bit socket Torx, long, T50 | 1 |
| 54 | 911.4325 | 1/2" Torx E Socket, E22 | 1 | 71 | 917.1211 | 1/2" Hexagonal socket, 11 mm | 1 | 80 | 911.1528 | 1/2" Bit socket Torx, long, T55 | 1 |
| 55 | 911.4326 | 1/2" Torx E Socket, E24 | 1 | 72 | 917.1212 | 1/2" Hexagonal socket, 12 mm | 1 | 81 | 911.1529 | 1/2" Bit socket Torx, long, T60 | 1 |
| 56 | 917.1221 | 1/2" Hexagonal socket, 21 mm | 1 | 73 | 917.1213 | 1/2" Hexagonal socket, 13 mm | 1 | 82 | 911.1517 | 1/2" Bit socket Torx, long, T70 | 1 |
| 57 | 917.1222 | 1/2" Hexagonal socket, 22 mm | 1 | 74 | 917.1214 | 1/2" Hexagonal socket, 14 mm | 1 | 91 | 911.1207 | 3/8" Sliding adaptor, 3/8" F x 1/2" M | 1 |
| 58 | 917.1223 | 1/2" Hexagonal socket, 23 mm | 1 | 83 | 911.1326 | 1/2" Bit socket hexagon, long, 6 mm | 1 | 92 | 911.1250 | 1/2" Universal joint | 1 |
| 59 | 917.1224 | 1/2" Hexagonal socket, 24 mm | 1 | 84 | 911.1327 | 1/2" Bit socket hexagon, long, 7 mm | 1 | 93 | 911.1202 | 1/2" Extensions, 125 mm | 1 |
| 60 | 917.1342 | 1/2" Hexagonal socket, 25 mm | 1 | 85 | 911.1328 | 1/2" Bit socket hexagon, long, 8 mm | 1 | 94 | 911.1203 | 1/2" Extensions, 250 mm | 1 |
| 61 | 917.1343 | 1/2" Hexagonal socket, 26 mm | 1 | 86 | 911.1329 | 1/2" Bit socket hexagon, long, 9 mm | 1 | 95 | 920.1290 | 1/2" SlimPOWER Reversible ratchet, 72 teeth | 1 |
| 62 | 917.1215 | 1/2" Hexagonal socket, 15 mm | 1 | 87 | 911.1330 | 1/2" Bit socket hexagon, long, 10 mm | 1 | | | | |
| 63 | 917.1216 | 1/2" Hexagonal socket, 16 mm | 1 | 88 | 911.1332 | 1/2" Bit socket hexagon, long, 12 mm | 1 | | | | |
| 64 | 917.1217 | 1/2" Hexagonal socket, 17 mm | 1 | 89 | 917.1332 | 1/2" Bit socket hexagon, long, 14 mm | 1 | | | | |
| 65 | 917.1218 | 1/2" Hexagonal socket, 18 mm | 1 | 90 | 911.1337 | 1/2" Bit socket hexagon, long, 17 mm | 1 | | | | |
| 66 | 917.1219 | 1/2" Hexagonal socket, 19 mm | 1 | 75 | 911.1523 | 1/2" Bit socket Torx, long, T27 | 1 | | | | |
| 67 | 917.1220 | 1/2" Hexagonal socket, 20 mm | 1 | 76 | 911.1524 | 1/2" Bit socket Torx, long, T30 | 1 | | | | |

811.0053

M Screw spanner set



568 x 398



P10



P10TC



P15



P20



P30



P35



P45



| Pos. | Code | Description | pcs | Pos. | Code | Description | pcs | Pos. | Code | Description | pcs |
|------|----------|-------------------------------------|-----|------|----------|--|-----|------|----------|---|-----|
| 1 | 517.0606 | Combination spanners, offset, 6 mm | 1 | 12 | 517.0617 | Combination spanners, offset, 17 mm | 1 | 22 | 911.0373 | Double ring spanner for Torx E profile, E10 x E12 | 1 |
| 2 | 517.0607 | Combination spanners, offset, 7 mm | 1 | 13 | 517.0618 | Combination spanners, offset, 18 mm | 1 | 23 | 911.0374 | Double ring spanner for Torx E profile, E14 x E18 | 1 |
| 3 | 517.0608 | Combination spanners, offset, 8 mm | 1 | 14 | 517.0619 | Combination spanners, offset, 19 mm | 1 | 24 | 911.0375 | Double ring spanner for Torx E profile, E16 x E22 | 1 |
| 4 | 517.0609 | Combination spanners, offset, 9 mm | 1 | 15 | 517.0620 | Combination spanners, offset, 20 mm | 1 | 25 | 911.0376 | Double ring spanner for Torx E profile, E20 x E24 | 1 |
| 5 | 517.0610 | Combination spanners, offset, 10 mm | 1 | 16 | 517.0621 | Combination spanners, offset, 21 mm | 1 | 26 | 517.0252 | Open double ring spanner, offset, 8 x 10 mm | 1 |
| 6 | 517.0611 | Combination spanners, offset, 11 mm | 1 | 17 | 517.0622 | Combination spanners, offset, 22 mm | 1 | 27 | 517.9244 | Open double ring spanner, offset, 11 x 13 mm | 1 |
| 7 | 517.0612 | Combination spanners, offset, 12 mm | 1 | 18 | 517.0623 | Combination spanners, offset, 23 mm | 1 | 28 | 517.0258 | Open double ring spanner, offset, 12 x 14 mm | 1 |
| 8 | 517.0613 | Combination spanners, offset, 13 mm | 1 | 19 | 517.0624 | Combination spanners, offset, 24 mm | 1 | 29 | 517.0263 | Open double ring spanner, offset, 16 x 18 mm | 1 |
| 9 | 517.0614 | Combination spanners, offset, 14 mm | 1 | 20 | 911.0371 | Double ring spanner for Torx E profile, E6 x E8 | 1 | 30 | 517.0264 | Open double ring spanner, offset, 17 x 19 mm | 1 |
| 10 | 517.0615 | Combination spanners, offset, 15 mm | 1 | 21 | 911.0372 | Double ring spanner for Torx E profile, E7 x E11 | 1 | | | | |
| 11 | 517.0616 | Combination spanners, offset, 16 mm | 1 | | | | | | | | |

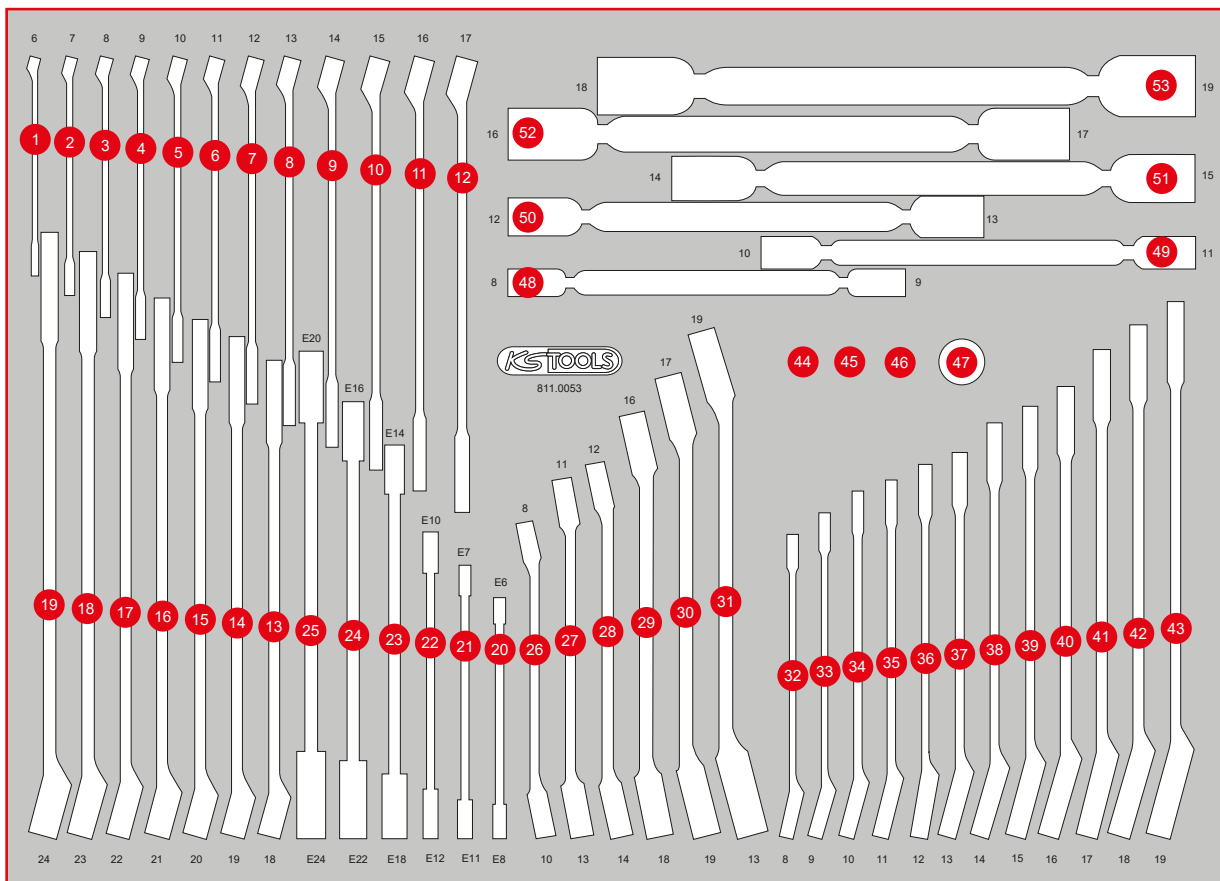

| Pos. | Code | Description | pcs | Pos. | Code | Description | pcs | Pos. | Code | Description | pcs |
|------|----------|--|-----|------|----------|--|-----|------|----------|---|-----|
| 31 | 517.0266 | Open double ring spanner, offset, 19 x 22 mm | 1 | 39 | 503.4615 | GEARplus reversing combination ratcheting spanner, 15 mm | 1 | 47 | 503.4298 | GEARplus socket adaptor, 1/2" x 19 mm | 1 |
| 32 | 503.4608 | GEARplus reversing combination ratcheting spanner, 8 mm | 1 | 40 | 503.4616 | GEARplus reversing combination ratcheting spanner, 16 mm | 1 | 48 | 517.0301 | Double revolving head spanner, 8 x 9 mm | 1 |
| 33 | 503.4609 | GEARplus reversing combination ratcheting spanner, 9 mm | 1 | 41 | 503.4617 | GEARplus reversing combination ratcheting spanner, 17 mm | 1 | 49 | 517.0302 | Double revolving head spanner, 10 x 11 mm | 1 |
| 34 | 503.4610 | GEARplus reversing combination ratcheting spanner, 10 mm | 1 | 42 | 503.4618 | GEARplus reversing combination ratcheting spanner, 18 mm | 1 | 50 | 517.0303 | Double revolving head spanner, 12 x 13 mm | 1 |
| 35 | 503.4611 | GEARplus reversing combination ratcheting spanner, 11 mm | 1 | 43 | 503.4619 | GEARplus reversing combination ratcheting spanner, 19 mm | 1 | 51 | 517.0304 | Double revolving head spanner, 14 x 15 mm | 1 |
| 36 | 503.4612 | GEARplus reversing combination ratcheting spanner, 12 mm | 1 | 44 | 503.4290 | GEARplus bit adaptor, 1/4" x 10 mm | 1 | 52 | 517.0305 | Double revolving head spanner, 16 x 17 mm | 1 |
| 37 | 503.4613 | GEARplus reversing combination ratcheting spanner, 13 mm | 1 | 45 | 503.4296 | GEARplus socket adaptor, 1/4" x 10 mm | 1 | 53 | 517.0306 | Double revolving head spanner, 18 x 19 mm | 1 |
| 38 | 503.4614 | GEARplus reversing combination ratcheting spanner, 14 mm | 1 | 46 | 503.4297 | GEARplus socket adaptor, 3/8" x 13 mm | 1 | | | | |

811.0073

M 3/8" + 1/2" socket spanner set



| Pos. | Code | Description | pcs | Pos. | Code | Description | pcs | Pos. | Code | Description | pcs |
|------|----------|--|-----|------|----------|---|-----|------|----------|---|-----|
| 1 | 515.1508 | 3/8" Hexagon impact socket, short, 8 mm | 1 | 14 | 515.1012 | 1/2" Hexagon impact socket short, 12 mm | 1 | 27 | 515.1025 | 1/2" Hexagon impact socket short, 25 mm | 1 |
| 2 | 515.1510 | 3/8" Hexagon impact socket, short, 10 mm | 1 | 15 | 515.1013 | 1/2" Hexagon impact socket short, 13 mm | 1 | 28 | 515.1026 | 1/2" Hexagon impact socket short, 26 mm | 1 |
| 3 | 515.1511 | 3/8" Hexagon impact socket, short, 11 mm | 1 | 16 | 515.1014 | 1/2" Hexagon impact socket short, 14 mm | 1 | 29 | 515.1027 | 1/2" Hexagon impact socket short, 27 mm | 1 |
| 4 | 515.1512 | 3/8" Hexagon impact socket, short, 12 mm | 1 | 17 | 515.1015 | 1/2" Hexagon impact socket short, 15 mm | 1 | 30 | 515.1028 | 1/2" Hexagon impact socket short, 28 mm | 1 |
| 5 | 515.1513 | 3/8" Hexagon impact socket, short, 13 mm | 1 | 18 | 515.1016 | 1/2" Hexagon impact socket short, 16 mm | 1 | 31 | 515.1029 | 1/2" Hexagon impact socket short, 29 mm | 1 |
| 6 | 515.1514 | 3/8" Hexagon impact socket, short, 14 mm | 1 | 19 | 515.1017 | 1/2" Hexagon impact socket short, 17 mm | 1 | 32 | 515.1030 | 1/2" Hexagon impact socket short, 30 mm | 1 |
| 7 | 515.1515 | 3/8" Hexagon impact socket, short, 15 mm | 1 | 20 | 515.1018 | 1/2" Hexagon impact socket short, 18 mm | 1 | 33 | 515.1032 | 1/2" Hexagon impact socket short, 32 mm | 1 |
| 8 | 515.1516 | 3/8" Hexagon impact socket, short, 16 mm | 1 | 21 | 515.1019 | 1/2" Hexagon impact socket short, 19 mm | 1 | 34 | 515.1144 | 1/2" Impact adaptor, 1/2" F x 3/4" M | 1 |
| 9 | 515.1517 | 3/8" Hexagon impact socket, short, 17 mm | 1 | 22 | 515.1020 | 1/2" Hexagon impact socket short, 20 mm | 1 | 35 | 515.1143 | 1/2" Impact adaptor, 1/2" F x 3/8" M | 1 |
| 10 | 515.1519 | 3/8" Hexagon impact socket, short, 19 mm | 1 | 23 | 515.1021 | 1/2" Hexagon impact socket short, 21 mm | 1 | 36 | 515.1532 | Impact adaptor, F 3/8" x 1/2" M | 1 |
| 11 | 515.1008 | 1/2" Hexagon impact socket short, 8 mm | 1 | 24 | 515.1022 | 1/2" Hexagon impact socket short, 22 mm | 1 | 37 | 515.1531 | Impact adaptor, F 3/8" x 1/4" M | 1 |
| 12 | 515.1010 | 1/2" Hexagon impact socket short, 10 mm | 1 | 25 | 515.1023 | 1/2" Hexagon impact socket short, 23 mm | 1 | 38 | 515.1599 | Impact bit adaptor socket, 3/8" x 1/4" | 1 |
| 13 | 515.1011 | 1/2" Hexagon impact socket short, 11 mm | 1 | 26 | 515.1024 | 1/2" Hexagon impact socket short, 24 mm | 1 | 39 | 515.1135 | 1/2" Impact extension, 125 mm | 1 |

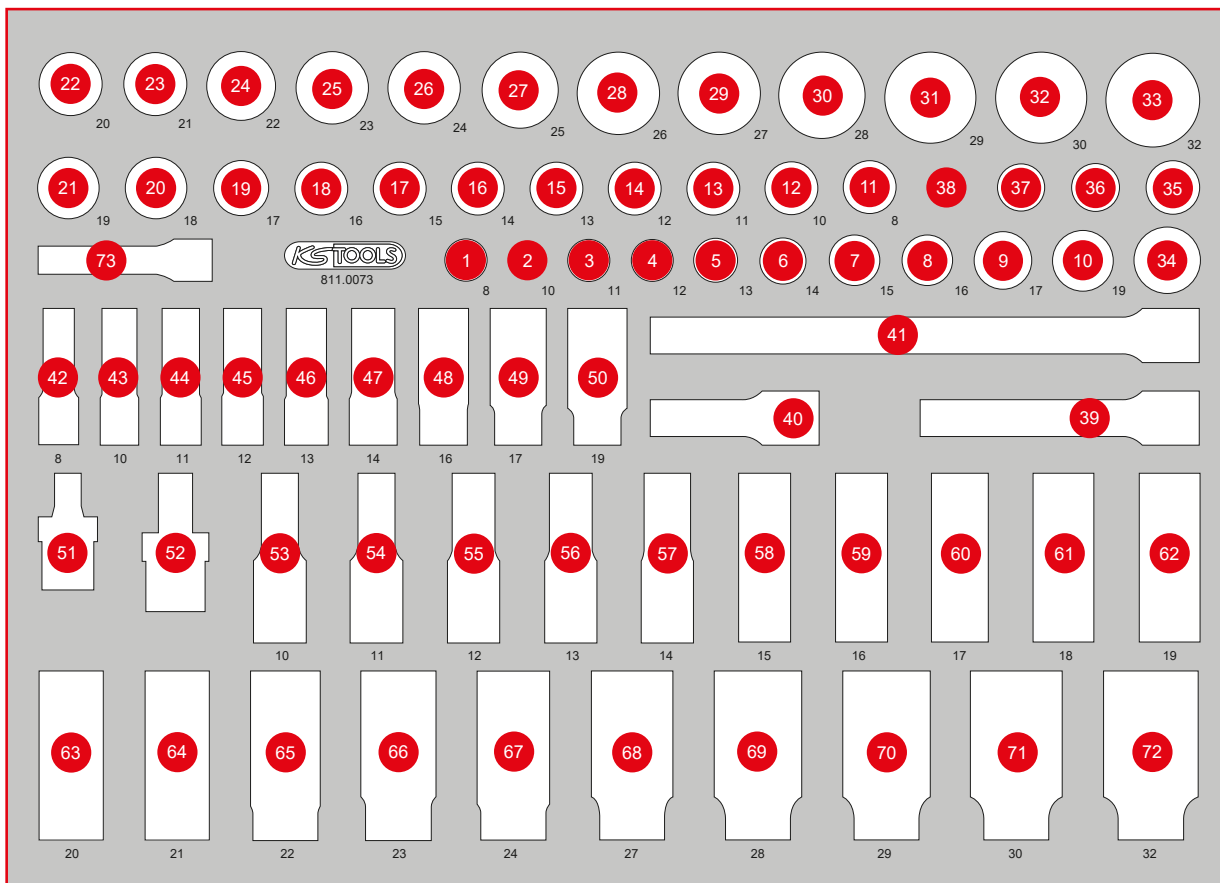

| Pos. | Code | Description | pcs | Pos. | Code | Description | pcs | Pos. | Code | Description | pcs |
|------|----------|---|-----|------|----------|---|-----|------|----------|---|-----|
| 40 | 515.1134 | 1/2" Impact extension, 75 mm | 1 | 53 | 515.1110 | 1/2" Hexagon impact socket, deep, 10 mm | 1 | 66 | 515.1123 | 1/2" Hexagon impact socket, deep, 23 mm | 1 |
| 41 | 515.1136 | 1/2" Impact extension, 250 mm | 1 | 54 | 515.1111 | 1/2" Hexagon impact socket, deep, 11 mm | 1 | 67 | 515.1124 | 1/2" Hexagon impact socket, deep, 24 mm | 1 |
| 42 | 515.1608 | 3/8" Hexagon impact socket, deep, 8 mm | 1 | 55 | 515.1112 | 1/2" Hexagon impact socket, deep, 12 mm | 1 | 68 | 515.1127 | 1/2" Hexagon impact socket, deep, 27 mm | 1 |
| 43 | 515.1610 | 3/8" Hexagon impact socket, deep, 10 mm | 1 | 56 | 515.1113 | 1/2" Hexagon impact socket, deep, 13 mm | 1 | 69 | 515.1128 | 1/2" Hexagon impact socket, deep, 28 mm | 1 |
| 44 | 515.1611 | 3/8" Hexagon impact socket, deep, 11 mm | 1 | 57 | 515.1114 | 1/2" Hexagon impact socket, deep, 14 mm | 1 | 70 | 515.1129 | 1/2" Hexagon impact socket, deep, 29 mm | 1 |
| 45 | 515.1612 | 3/8" Hexagon impact socket, deep, 12 mm | 1 | 58 | 515.1115 | 1/2" Hexagon impact socket, deep, 15 mm | 1 | 71 | 515.1130 | 1/2" Hexagon impact socket, deep, 30 mm | 1 |
| 46 | 515.1613 | 3/8" Hexagon impact socket, deep, 13 mm | 1 | 59 | 515.1116 | 1/2" Hexagon impact socket, deep, 16 mm | 1 | 72 | 515.1132 | 1/2" Hexagon impact socket, deep, 32 mm | 1 |
| 47 | 515.1614 | 3/8" Hexagon impact socket, deep, 14 mm | 1 | 60 | 515.1117 | 1/2" Hexagon impact socket, deep, 17 mm | 1 | 73 | 515.1534 | 3/8" Impact extension, 75 mm | 1 |
| 48 | 515.1616 | 3/8" Hexagon impact socket, deep, 16 mm | 1 | 61 | 515.1118 | 1/2" Hexagon impact socket, deep, 18 mm | 1 | | | | |
| 49 | 515.1617 | 3/8" Hexagon impact socket, deep, 17 mm | 1 | 62 | 515.1119 | 1/2" Hexagon impact socket, deep, 19 mm | 1 | | | | |
| 50 | 515.1619 | 3/8" Hexagon impact socket, deep, 19 mm | 1 | 63 | 515.1120 | 1/2" Hexagon impact socket, deep, 20 mm | 1 | | | | |
| 51 | 515.1533 | 3/8" Impact universal ball joint | 1 | 64 | 515.1121 | 1/2" Hexagon impact socket, deep, 21 mm | 1 | | | | |
| 52 | 515.1133 | 1/2" Impact universal ball joint | 1 | 65 | 515.1122 | 1/2" Hexagon impact socket, deep, 22 mm | 1 | | | | |

M Pliers, Hammer and chisel set



| Pos. | Code | Description | pcs |
|------|----------|---|-----|
| 1 | 156.0237 | Punch, Ø 3 mm, conical | 1 |
| 2 | 156.0238 | Punch, Ø 4 mm, conical | 1 |
| 3 | 156.0244 | Punch, Ø 5 mm, conical | 1 |
| 4 | 156.0241 | Flat chisel, octagon, 20 mm | 1 |
| 5 | 156.0231 | Pin punch, Ø 3 mm, cylindrical shaft | 1 |
| 6 | 156.0232 | Pin punch, Ø 4 mm, cylindrical shaft | 1 |
| 7 | 156.0233 | Pin punch, Ø 5 mm, cylindrical shaft | 1 |
| 8 | 156.0234 | Pin punch, Ø 6 mm, cylindrical shaft | 1 |
| 9 | 156.0254 | Flat chisel, octagon, 18 mm | 1 |
| 10 | 500.1026 | Circlip pliers for external circlips, angled, 160 mm | 1 |
| 11 | 500.1029 | Circlip pliers for external circlips, 160 mm | 1 |
| 12 | 500.1032 | Circlip pliers for internal circlips, angled, 160 mm | 1 |
| 13 | 500.1035 | Circlip pliers for internal circlips, 160 mm | 1 |
| 14 | 115.2010 | Water pump pliers, 240 mm | 1 |
| 15 | 115.1033 | Self grip wrench, 220 mm | 1 |
| 16 | 300.0114 | Tape measure with locking device and belt clip, black red, 5 m, 19 mm | 1 |
| 17 | 115.1012 | ERGOTORQUE diagonal side cutter, 160 mm | 1 |
| 18 | 115.1019 | ERGOTORQUE bent nose pliers serrated, 210 mm | 1 |
| 19 | 115.1021 | ERGOTORQUE combination pliers, 180 mm | 1 |
| 20 | 115.1024 | ERGOTORQUE long nose pliers serrated cutter, 200 mm | 1 |
| 21 | 142.1402 | Fitters Hammer, fibreglas handle, 400g | 1 |
| 22 | 142.5101 | Club Hammer, fibreglas handle, 1000g | 1 |

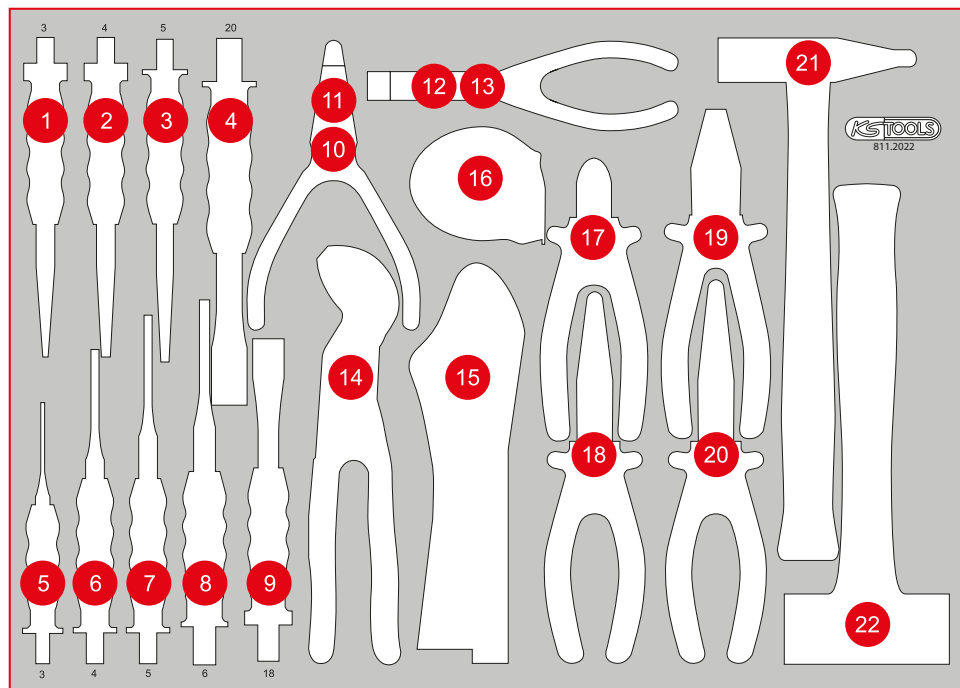

P10

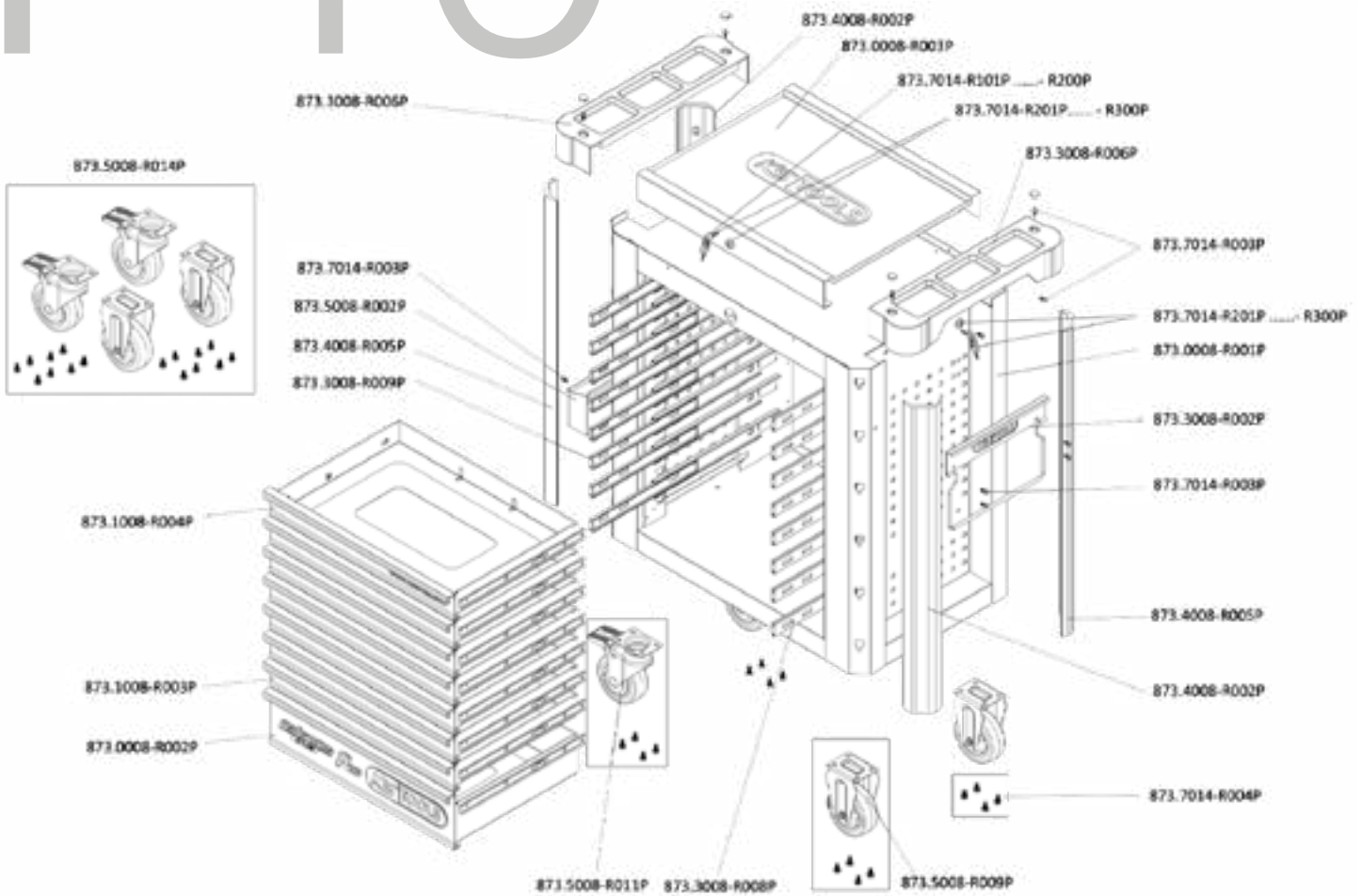

INDIVIDUAL PARTS LIST

| Item No. | Description | Amount |
|-------------------|--|--------|
| 873.7014-R101P... | Replacement key for PERFORMANCEplus workshop trolley lock number xyz | 2 |
| 873.7014-R201P... | Lock with 2 keys for PERFORMANCEplus workshop trolley lock number xyz | 2 |
| 873.0008-R001P | Body with handle | 1 |
| 873.0008-R002P | Compartment with logo and ball-bearing guide, 568x398x145 mm | 1 |
| 873.0008-R003P | Stainless steel worktop | 1 |
| 873.1008-R003P | Compartment with ball-bearing guide, for workshop trolley P10/P10TC/P15, 568x398x65 mm | 6 |
| 873.1008-R004P | Compartment with website and ball-bearing guide, for workshop trolley P10/P15, 568x398x65 mm | 1 |
| 873.3008-R002P | Paper roll holder for PERFORMANCEplus workshop trolley | 1 |
| 873.3008-R006P | Storage for work surface | 2 |
| 873.3008-R008P | Full extension (with ball-bearing guide) with automatic retraction | 8 |
| 873.3008-R009P | Full extension (with ball-bearing guide) with automatic retraction | 8 |
| 873.4008-R002P | Plastic bumpers | 2 |
| 873.4008-R005P | Plastic bumpers | 2 |
| 873.5008-R002P | Can holder for PERFORMANCEplus workshop trolley | 1 |
| 873.5008-R009P | Fixed castors for PERFORMANCEplus workshop trolley, incl. screws | 2 |
| 873.5008-R011P | Swivel castors with brakes, for PERFORMANCEplus workshop trolley, incl. screws | 2 |
| 873.5008-R014P | Roller set for PERFORMANCEplus workshop trolley, incl. screws | 1 |
| 873.7014-R003P | M6x12 screws for PERFORMANCEplus workshop trolley accessories | 14 |
| 873.7014-R004P | M8 screws for PERFORMANCEplus workshop trolley rollers (16 pcs.) | 1 |



873.7014-R101P...R200P
Replacement key for lock number xyz



873.7014-R201P...R300P
Lock with 2 keys for lock number xyz



873.3008-R008P
Full extension (with ball-bearing guide) with automatic retraction, right



873.3008-R009P
Full extension (with ball-bearing guide) with automatic retraction, left



873.5008-R009P
Fixed castors, incl. screws



873.5008-R011P
Swivel castors with brakes, incl. screws

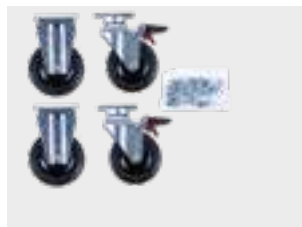

873.5008-R014P
Roller set, incl. screws



873.0008-R003P
Stainless steel work surface



873.3008-R006P
Storage for work surface, including screw cover, usable on both sides



873.1008-R004P
Compartment with website and ball-bearing guide, 568x398x65 mm



873.1008-R003P
Compartment with ball-bearing guide, 568x398x65 mm



873.0008-R002P
Compartment with logo and ball-bearing guide, 568x398x145 mm



873.5008-R002P
Can holder, 310 mm



873.3008-R002P
Paper roll holder, 320 mm



873.4008-R005P
Plastic bumpers, front left, back right



873.4008-R002P
Plastic bumpers, front right, back left



873.7014-R004P
M8 screws (16 pcs.)



873.7014-R003P
M6x12 screw (1 pcs.)



873.0008-R001P
Body with handle



A thousand great parts for tough guys!

