

# P10

**workshop tool trolley**  
with 536 tools for 8 drawers  
**810.8536**

---

**Workshop trolley P10**

with 8 compartments

873.0008

# THE ENTRY MODEL TO SATISFY HIGH STANDARDS



P10



**DUO Lock** Brilliant locking system



**Eight drawers** each load capacity up to 50 kg



Stable **ball bearing**



**Stainless steel surface**



**Lock** lockable



**Anti-static castors** with brakes



Integrated **corner protection**



**Paper roll holder** included



**Can holder** included

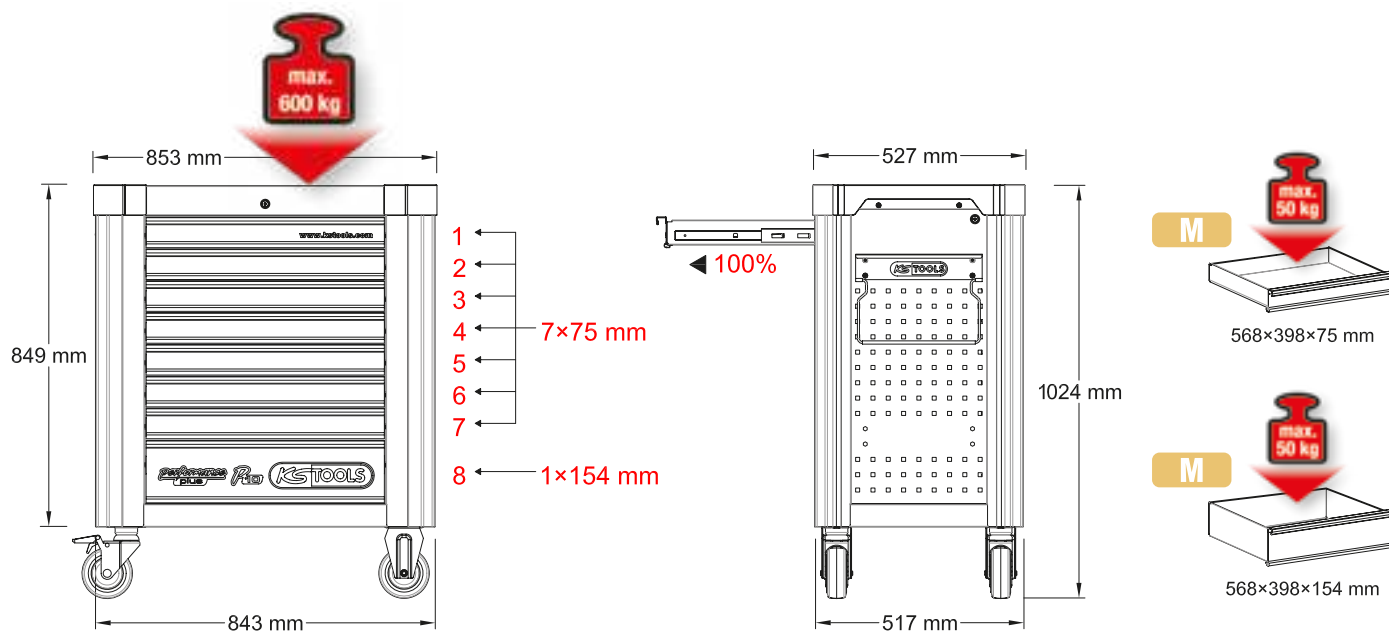

# P10 workshop tool trolley set with 536 tools for 8 drawers

810.8536



IPCS  
536

M

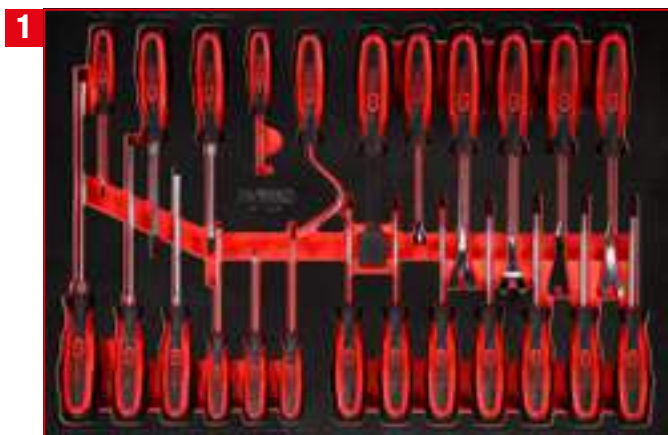

Screwdriver set in foam insert

811.3024

IPCS  
24

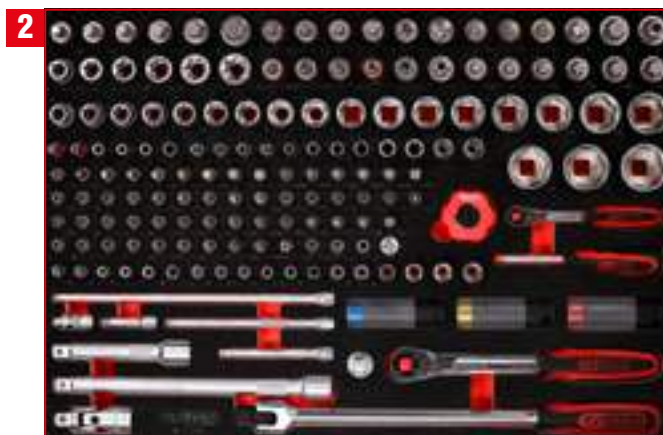

1/4" + 1/2" socket spanner set in foam insert

811.0167

IPCS  
167



3/8" socket spanner set in foam insert

811.0124

124 PCS



1/2" socket spanner and screwdriver bit set

811.0063

63 PCS



Screw spanner set in foam insert

811.0050

50 PCS



Spanner and impact socket set in foam insert

811.1055

55 PCS



Screwdriver and spanner set in foam insert

811.1032

32 PCS



Hammer, chisel and file set in foam insert

811.0021

21 PCS

P 10

P 15

P 20

P 25

P 30

P 35

P 40

P 45

Single inserts

Individual parts

Accessories

811.3024

**M** Screwdriver set

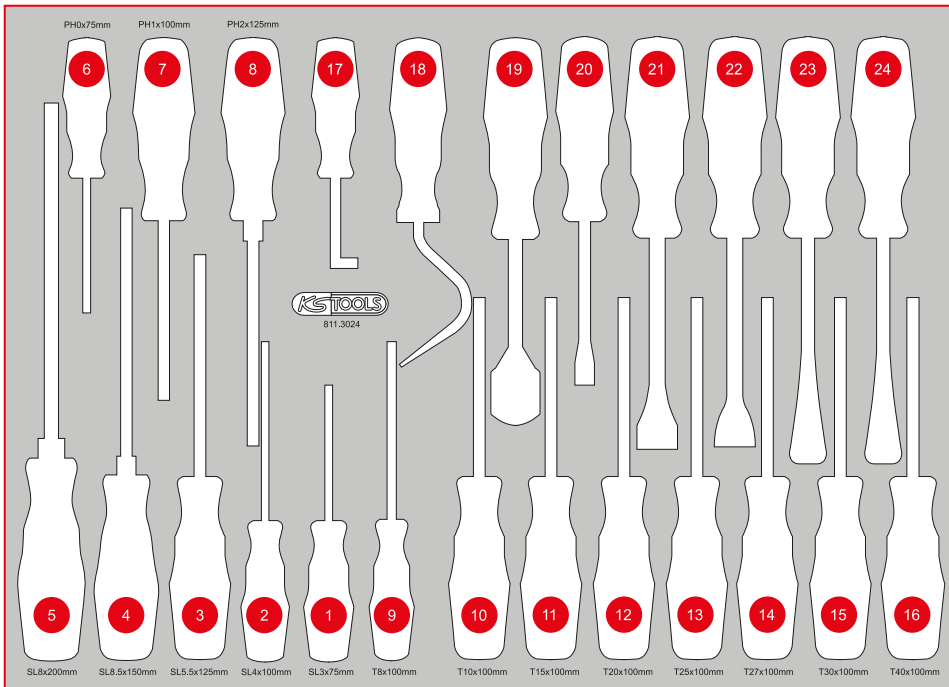

Pos.	Code	Description	pcs
1	159.1002	ERGOTORQUEplus screwdriver for slotted screws, 3 mm, 155 mm	1
2	159.1004	ERGOTORQUEplus screwdriver for slotted screws, 4 mm, 180 mm	1
3	159.1006	ERGOTORQUEplus screwdriver for slotted screws, 5,5 mm, 230 mm	1
4	159.1011	ERGOTORQUEplus screwdriver for slotted screws, 8 mm, 315 mm	1
5	159.1009	ERGOTORQUEplus screwdriver for slotted screws, 6,5 mm, 255 mm	1
6	159.1027	ERGOTORQUEplus screwdriver for screws PH, PH0, 155 mm	1
7	159.1029	ERGOTORQUEplus screwdriver for screws PH, PH1, 205 mm	1
8	159.1022	ERGOTORQUEplus screwdriver for screws PH, PH2, 230 mm	1
9	159.1030	ERGOTORQUEplus screwdriver, Torx, T8	1
10	159.1032	ERGOTORQUEplus screwdriver, Torx, T10	1
11	159.1033	ERGOTORQUEplus screwdriver, Torx, T15	1
12	159.1034	ERGOTORQUEplus screwdriver, Torx, T20	1
13	159.1035	ERGOTORQUEplus screwdriver, Torx, T25	1
14	159.1036	ERGOTORQUEplus screwdriver, Torx, T27	1
15	159.1037	ERGOTORQUEplus screwdriver, Torx, T30	1
16	159.1038	ERGOTORQUEplus screwdriver, Torx, T40	1
17	550.1048	Hook, 90° offset	1
18	550.1073	Hook, large, sickle	1
19	907.2222	Gasket scraper, 25 x 200 mm	1
20	140.2371	Clip remover short, length 245 mm, opening 4 mm	1
21	140.2616	Clip remover short, length 240 mm, opening 7,5 mm	1
22	140.2615	Clip remover short, length 240 mm, opening 9 mm	1
23	140.2617	Clip remover short, length 240 mm, opening 5 mm	1
24	140.2373	Clip remover short, length 245 mm, opening 10 mm	1

# M 1/4" + 1/2" socket spanner set



568 x 398



P10



P10TC



P15



P20



P30



P35



P45



Pos.	Code	Description	pcs	Pos.	Code	Description	pcs	Pos.	Code	Description	pcs
1	911.1308	1/2" Bit socket hexagon, short, 8 mm	1	29	911.1379	1/2" Bit socket Torx tamperproof, TB60	1	58	917.2402	1/4" Torx E Socket, deep, E5	1
2	911.1309	1/2" Bit socket hexagon, short, 9 mm	1	30	911.1380	1/2" Bit socket Torx tamperproof, TB70	1	59	917.2403	1/4" Torx E Socket, deep, E6	1
3	911.1310	1/2" Bit socket hexagon, short, 10 mm	1	31	911.4515	Bit socket for RIBE screws, M9, length 55 mm	1	60	917.2404	1/4" Torx E Socket, deep, E7	1
4	911.1312	1/2" Bit socket hexagon, short, 12 mm	1	32	911.4516	Bit socket for RIBE screws, M10, Length 55 mm	1	61	917.2405	1/4" Torx E Socket, deep, E8	1
5	911.1314	1/2" Bit socket hexagon, short, 14 mm	1	33	911.4551	Bit socket for RIBE screws, M10.1, Length 55 mm	1	62	917.2406	1/4" Torx E Socket, deep, E10	1
6	911.1317	1/2" Bit socket hexagon, short, 17 mm	1	34	911.4517	Bit socket for RIBE screws, M12, Length 55 mm	1	63	917.1525	1/4" Hexagonal socket, deep, 4 mm	1
7	911.1365	1/2" Bit socket Torx, T40	1	35	911.4518	Bit socket for RIBE screws, M13, Length 55 mm	1	64	917.1526	1/4" Hexagonal socket, deep, 4,5 mm	1
8	911.1366	1/2" Bit socket Torx, T45	1	36	911.4519	Bit socket for RIBE screws, M14, Length 55 mm	1	65	917.1527	1/4" Hexagonal socket, deep, 5 mm	1
9	911.1367	1/2" Bit socket Torx, T50	1	37	917.1210	1/2" Hexagonal socket, 10 mm	1	66	917.1528	1/4" Hexagonal socket, deep, 5,5 mm	1
10	911.1368	1/2" Bit socket Torx, T55	1	38	917.1211	1/2" Hexagonal socket, 11 mm	1	67	917.1426	1/4" Hexagonal socket, deep, 6 mm	1
11	911.1369	1/2" Bit socket Torx, T60	1	39	917.1212	1/2" Hexagonal socket, 12 mm	1	68	917.1427	1/4" Hexagonal socket, deep, 7 mm	1
12	911.1370	1/2" Bit socket Torx, T70	1	40	917.1213	1/2" Hexagonal socket, 13 mm	1	69	917.1428	1/4" Hexagonal socket, deep, 8 mm	1
13	911.1313	1/2" Bit socket spline (XZN), M9, 55 mm	1	41	917.1214	1/2" Hexagonal socket, 14 mm	1	70	917.1429	1/4" Hexagonal socket, deep, 9 mm	1
14	911.1343	1/2" Bit socket spline (XZN), M10, 55 mm	1	42	917.1215	1/2" Hexagonal socket, 15 mm	1	71	917.1430	1/4" Hexagonal socket, deep, 10 mm	1
15	911.1344	1/2" Bit socket spline (XZN), M12, 55 mm	1	43	917.1216	1/2" Hexagonal socket, 16 mm	1	72	917.1431	1/4" Hexagonal socket, deep, 11 mm	1
16	911.1345	1/2" Bit socket spline (XZN), M14, 55 mm	1	44	917.1217	1/2" Hexagonal socket, 17 mm	1	73	917.1432	1/4" Hexagonal socket, deep, 12 mm	1
17	911.1346	1/2" Bit socket spline (XZN), M16, 55 mm	1	45	917.1218	1/2" Hexagonal socket, 18 mm	1	74	917.1433	1/4" Hexagonal socket, deep, 13 mm	1
18	911.1348	1/2" Bit socket spline (XZN) tamperproof, M16, 55 mm	1	46	917.1219	1/2" Hexagonal socket, 19 mm	1	75	911.1436	1/4" Bit socket hexagon, 3 mm	1
19	911.4336	1/2" Torx E Socket, E14	1	47	917.1220	1/2" Hexagonal socket, 20 mm	1	76	911.1437	1/4" Bit socket hexagon, 4 mm	1
20	911.4322	1/2" Torx E Socket, E16	1	48	917.1221	1/2" Hexagonal socket, 21 mm	1	77	911.1438	1/4" Bit socket hexagon, 5 mm	1
21	911.4323	1/2" Torx E Socket, E18	1	49	917.1222	1/2" Hexagonal socket, 22 mm	1	78	911.14385	1/4" Bit socket hexagon, 5,5 mm	1
22	911.4324	1/2" Torx E Socket, E20	1	50	917.1223	1/2" Hexagonal socket, 23 mm	1	79	911.1439	1/4" Bit socket hexagon, 6 mm	1
23	911.4325	1/2" Torx E Socket, E22	1	51	917.1224	1/2" Hexagonal socket, 24 mm	1	80	911.1440	1/4" Bit socket hexagon, 7 mm	1
24	911.4326	1/2" Torx E Socket, E24	1	52	917.1343	1/2" Hexagonal socket, 26 mm	1	81	911.1441	1/4" Bit socket hexagon, 8 mm	1
25	911.1375	1/2" Bit socket Torx tamperproof, TB40	1	53	917.1227	1/2" Hexagonal socket, 27 mm	1	82	917.1454	1/4" Bit socket hexagon, 9 mm	1
26	911.1376	1/2" Bit socket Torx tamperproof, TB45	1	54	917.1344	1/2" Hexagonal socket, 28 mm	1	83	917.1452	1/4" Bit socket hexagon, 10 mm	1
27	911.1377	1/2" Bit socket Torx tamperproof, TB50	1	55	917.1230	1/2" Hexagonal socket, 30 mm	1	84	917.1584	1/4" RIBE Socket M4S	1
28	911.1378	1/2" Bit socket Torx tamperproof, TB55	1	56	917.1232	1/2" Hexagonal socket, 32 mm	1	85	917.1585	1/4" RIBE Socket M5S	1
				57	917.2401	1/4" Torx E Socket, deep, E4	1	86	917.1586	1/4" RIBE Socket M6S	1

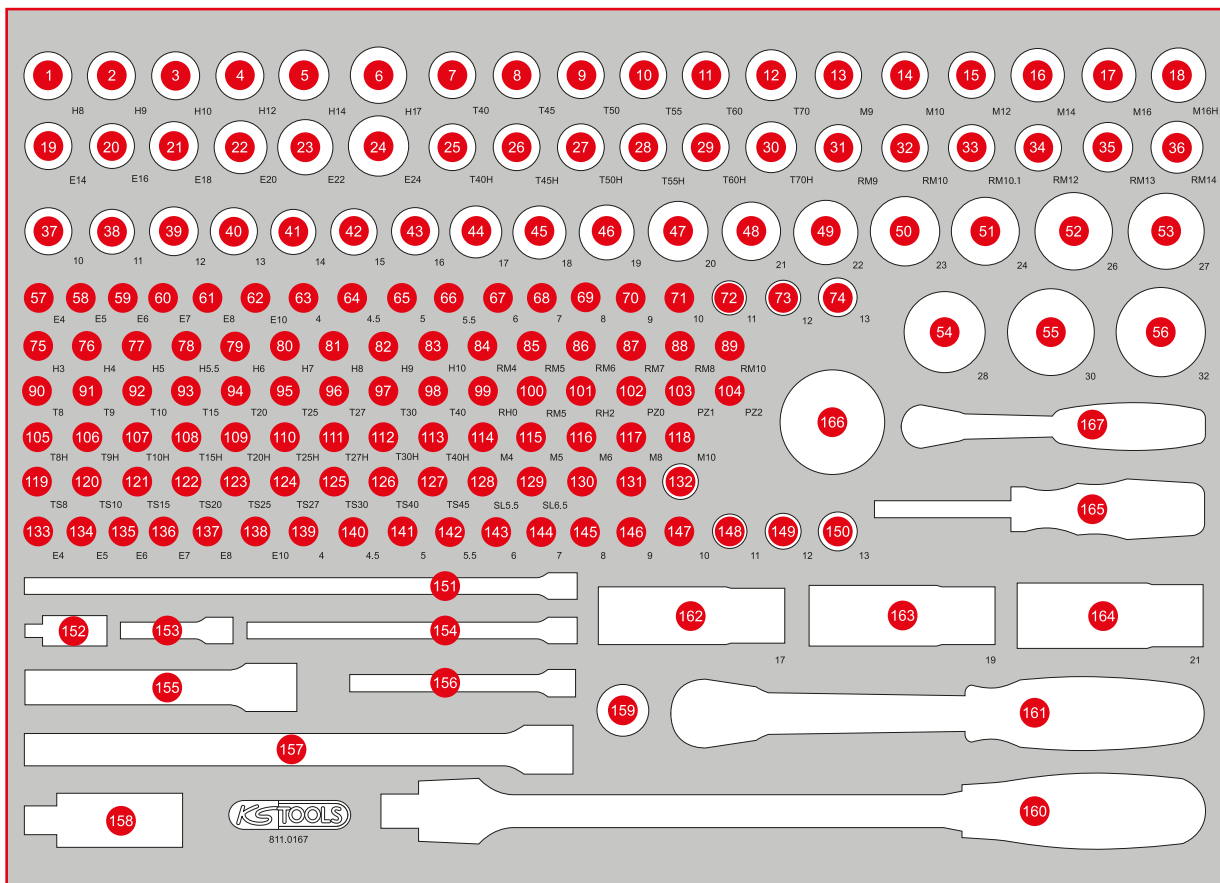

Pos.	Code	Description	pcs	Pos.	Code	Description	pcs	Pos.	Code	Description	pcs
87	917.1587	1/4" RIBE Socket M7S	1	116	917.1543	1/4" Bit socket spline (XZN), M6	1	145	917.1408	1/4" Hexagonal socket, 8 mm	1
88	917.1588	1/4" RIBE Socket M8S	1	117	917.1545	1/4" Bit socket spline (XZN), M8	1	146	917.1409	1/4" Hexagonal socket, 9 mm	1
89	917.1590	1/4" RIBE Socket M10S	1	118	917.1546	1/4" Bit socket spline (XZN), M10	1	147	917.1410	1/4" Hexagonal socket, 10 mm	1
90	911.1448	1/4" Bit socket Torx, T8	1	119	917.1578	1/4" Torx Plus bit socket 8IPR	1	148	917.1411	1/4" Hexagonal socket, 11 mm	1
91	911.1478	1/4" Bit socket Torx, T9	1	120	911.1701	1/4" Bit socket five star tamperproof, TS10	1	149	917.1412	1/4" Hexagonal socket, 12 mm	1
92	911.1442	1/4" Bit socket Torx, T10	1	121	911.1702	1/4" Bit socket five star tamperproof, TS15	1	150	917.1413	1/4" Hexagonal socket, 13 mm	1
93	911.1443	1/4" Bit socket Torx, T15	1	122	911.1703	1/4" Bit socket five star tamperproof, TS20	1	151	911.1543	1/4" Wobble extension with hexagon drive, 250 mm	1
94	911.1444	1/4" Bit socket Torx, T20	1	123	911.1704	1/4" Bit socket five star tamperproof, TS25	1	152	911.1450	1/4" Universal joint	1
95	911.1445	1/4" Bit socket Torx, T25	1	124	911.1705	1/4" Bit socket five star tamperproof, TS27	1	153	911.1423	1/4" Extension with hexagon drive, 50 mm	1
96	911.1449	1/4" Bit socket Torx, T27	1	125	911.1706	1/4" Bit socket five star tamperproof, TS30	1	154	911.1451	1/4" Extension with hexagon drive, 150 mm	1
97	911.1446	1/4" Bit socket Torx, T30	1	126	911.1707	1/4" Bit socket five star tamperproof, TS40	1	155	911.1202	1/2" Extensions, 125 mm	1
98	911.1447	1/4" Bit socket Torx, T40	1	127	911.1708	1/4" Bit socket five star tamperproof, TS45	1	156	911.1424	1/4" Extension with hexagon drive, 100 mm	1
99	911.1482	1/4" Bit socket, PH0	1	128	911.1419	1/4" Bit socket slot, 5,5 mm	1	157	911.1203	1/2" Extensions, 250 mm	1
100	911.1415	1/4" Bit socket, PH1	1	129	917.1421	1/4" Bit socket slot, 6,5 mm	1	158	911.1250	1/2" Universal joint	1
101	911.1416	1/4" Bit socket, PH2	1	130	911.0101	1/4" socket with magnet	1	159	911.1207	3/8" Sliding adaptor, 3/8" F x 1/2" M	1
102	911.1483	1/4" Bit socket, PZ0	1	131	911.1494	Adaptor, 1/4" Mx3/8" F	1	160	917.1455	1/2" Flexi head drive handle	1
103	911.1401	1/4" Bit socket, PZ1	1	132	911.3897	3/8" Reducing adaptor, 3/8" F x 1/4" M	1	161	920.1290	1/2" SlimPOWER Reversible ratchet, 72 teeth	1
104	911.1402	1/4" Bit socket, PZ2	1	133	911.4313	1/4" Torx E Socket, E4	1	162	515.0992	SlimPOWER 1/2" Alloy rim impact socket, 17 mm	1
105	911.1461	1/4" Bit socket Torx tamperproof, TB8	1	134	911.4314	1/4" Torx E Socket, E5	1	163	515.0993	SlimPOWER 1/2" Alloy rim impact socket, 19 mm	1
106	911.1485	1/4" Bit socket Torx tamperproof, TB9	1	135	911.4315	1/4" Torx E Socket, E6	1	164	515.0994	SlimPOWER 1/2" Alloy rim impact socket, 21 mm	1
107	911.1462	1/4" Bit socket Torx tamperproof, TB10	1	136	911.4316	1/4" Torx E Socket, E7	1	165	911.1434	1/4" Square drive screwdriver, 150 mm	1
108	911.1463	1/4" Bit socket Torx tamperproof, TB15	1	137	911.4317	1/4" Torx E Socket, E8	1	166	914.1410	Mini hand reversible ratchet, 1/4", 72 teeth	1
109	911.1464	1/4" Bit socket Torx tamperproof, TB20	1	138	911.4332	1/4" Torx E Socket, E10	1	167	920.1490	1/4" SlimPOWER Reversible ratchet, 72 teeth	1
110	911.1465	1/4" Bit socket Torx tamperproof, TB25	1	139	917.1404	1/4" Hexagonal socket, 4 mm	1				
111	911.1466	1/4" Bit socket Torx tamperproof, TB27	1	140	917.14045	1/4" Hexagonal socket, 4,5 mm	1				
112	911.1467	1/4" Bit socket Torx tamperproof, TB30	1	141	917.1405	1/4" Hexagonal socket, 5 mm	1				
113	911.1468	1/4" Bit socket Torx tamperproof, TB40	1	142	917.14055	1/4" Hexagonal socket, 5,5 mm	1				
114	917.1541	1/4" Bit socket spline (XZN), M4	1	143	917.1406	1/4" Hexagonal socket, 6 mm	1				
115	917.1542	1/4" Bit socket spline (XZN), M5	1	144	917.1407	1/4" Hexagonal socket, 7 mm	1				

# M 3/8" Socket spanner set



568 x 398



P10



P10TC



P15



P20



P30



P35



P45

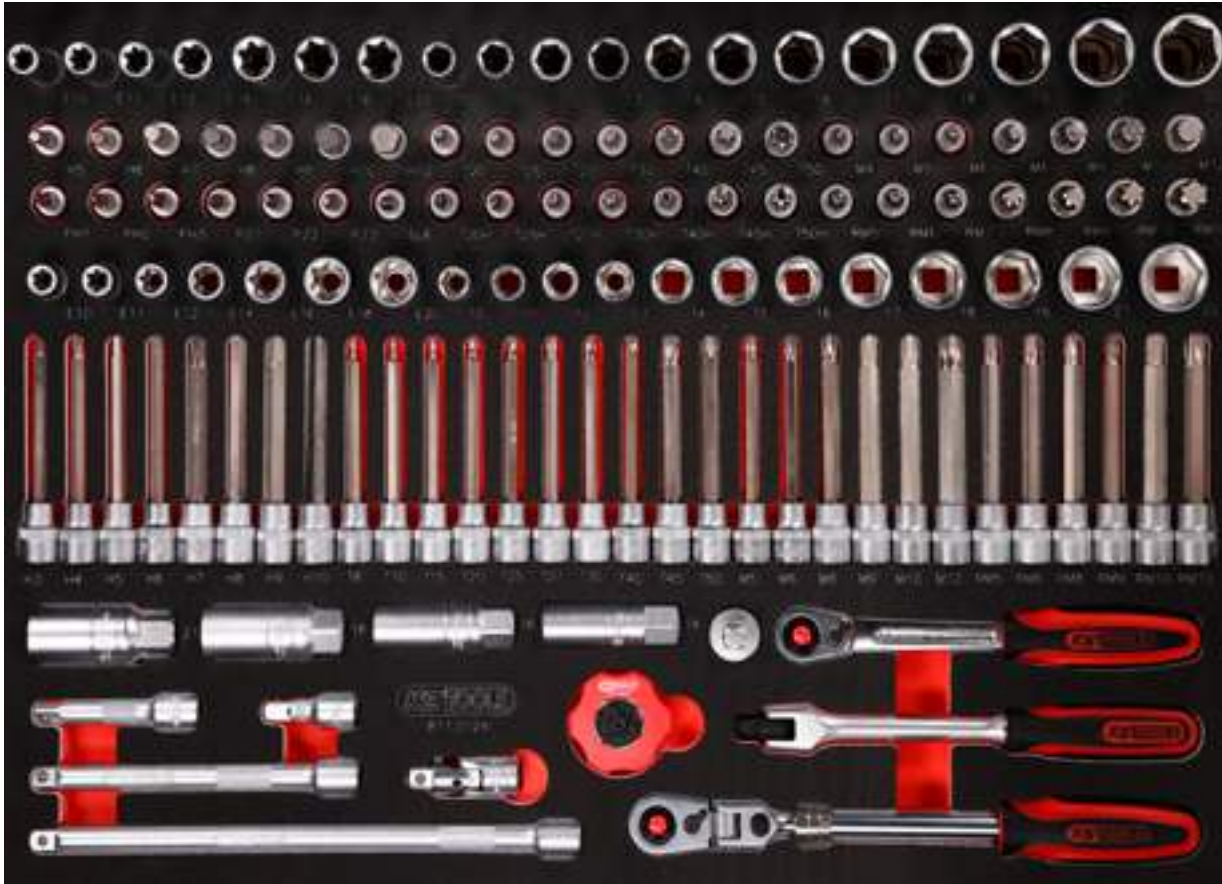

Pos.	Code	Description	pcs	Pos.	Code	Description	pcs	Pos.	Code	Description	pcs
1	914.3820	3/8" SlimPOWER Telescopic reversible ratchet, 72 teeth	1	21	917.1594	3/8" Bit socket hexagon, long, 9 mm	1	43	917.3935	3/8" RIBE® Bit socket, long, M10	1
2	917.3939	3/8" Flexi head drive handle	1	22	911.1566	3/8" Bit socket hexagon, long, 10 mm	1	44	917.3936	3/8" RIBE® Bit socket, long, M12	1
3	920.3890	3/8" SlimPOWER Reversible ratchet, 72 teeth	1	23	917.1576	3/8" Bit socket Torx, long, T8	1	45	911.4318	3/8" Torx E Socket, E10	1
4	914.3810	Mini hand reversible ratchet, 3/8", 72 teeth	1	24	917.1577	3/8" Bit socket Torx, long, T10	1	46	911.4319	3/8" Torx E Socket, E11	1
5	911.3826	3/8" Sliding / reducing adaptor, 1/2"F x 3/8"M	1	25	917.1579	3/8" Bit socket Torx, long, T15	1	47	911.4320	3/8" Torx E Socket, E12	1
6	911.3990	3/8" Special spark plug socket, thin-walled 14 mm	1	26	911.1551	3/8" Bit socket Torx, long, T20	1	48	911.4321	3/8" Torx E Socket, E14	1
7	911.3804	3/8" Spark plug socket, 16 mm	1	27	911.1552	3/8" Bit socket Torx, long, T25	1	49	911.4343	3/8" Torx E Socket, E16	1
8	911.3823	3/8" Spark plug socket, 18 mm	1	28	911.1553	3/8" Bit socket Torx, long, T27	1	50	911.4344	3/8" Torx E Socket, E18	1
9	911.3805	3/8" Spark plug socket, 21 mm	1	29	911.1554	3/8" Bit socket Torx, long, T30	1	51	911.4345	3/8" Torx E Socket, E20	1
10	911.3850	3/8" Universal joint	1	30	911.1555	3/8" Bit socket Torx, long, T40	1	52	917.3810	3/8" Hexagonal socket, 10 mm	1
11	911.3852	3/8" Extension with knurling, 45 mm	1	31	911.1556	3/8" Bit socket Torx, long, T45	1	53	917.3811	3/8" Hexagonal socket, 11 mm	1
12	911.3801	3/8" Extension with knurling, 75 mm	1	32	911.1557	3/8" Bit socket Torx, long, T50	1	54	917.3812	3/8" Hexagonal socket, 12 mm	1
13	911.3802	3/8" Extension with knurling, 150 mm	1	33	917.3904	XZN spline bit socket, 3/8", M5, long	1	55	917.3813	3/8" Hexagonal socket, 13 mm	1
14	911.3803	3/8" Extension with knurling, 250 mm	1	34	917.3905	XZN spline bit socket, 3/8", M6, long	1	56	917.3814	3/8" Hexagonal socket, 14 mm	1
15	917.1593	3/8" Bit socket hexagon, long, 3 mm	1	35	917.3906	XZN spline bit socket, 3/8", M8, long	1	57	917.3815	3/8" Hexagonal socket, 15 mm	1
16	911.1561	3/8" Bit socket hexagon, long, 4 mm	1	36	917.3907	XZN spline bit socket, 3/8", M9, long	1	58	917.3816	3/8" Hexagonal socket, 16 mm	1
17	911.1562	3/8" Bit socket hexagon, long, 5 mm	1	37	917.3908	XZN spline bit socket, 3/8", M10, long	1	59	917.3817	3/8" Hexagonal socket, 17 mm	1
18	911.1563	3/8" Bit socket hexagon, long, 6 mm	1	38	917.3909	XZN spline bit socket, 3/8", M12, long	1	60	917.3818	3/8" Hexagonal socket, 18 mm	1
19	911.1564	3/8" Bit socket hexagon, long, 7 mm	1	39	917.3930	3/8" RIBE® Bit socket, long, M5	1	61	917.3819	3/8" Hexagonal socket, 19 mm	1
20	911.1565	3/8" Bit socket hexagon, long, 8 mm	1	40	917.3931	3/8" RIBE® Bit socket, long, M6	1	62	917.3821	3/8" Hexagonal socket, 21 mm	1
				41	917.3933	3/8" RIBE® Bit socket, long, M8	1	63	917.3822	3/8" Hexagonal socket, 22 mm	1
				42	917.3934	3/8" RIBE® Bit socket, long, M9	1	64	911.3875	3/8" Bit socket, PH1	1

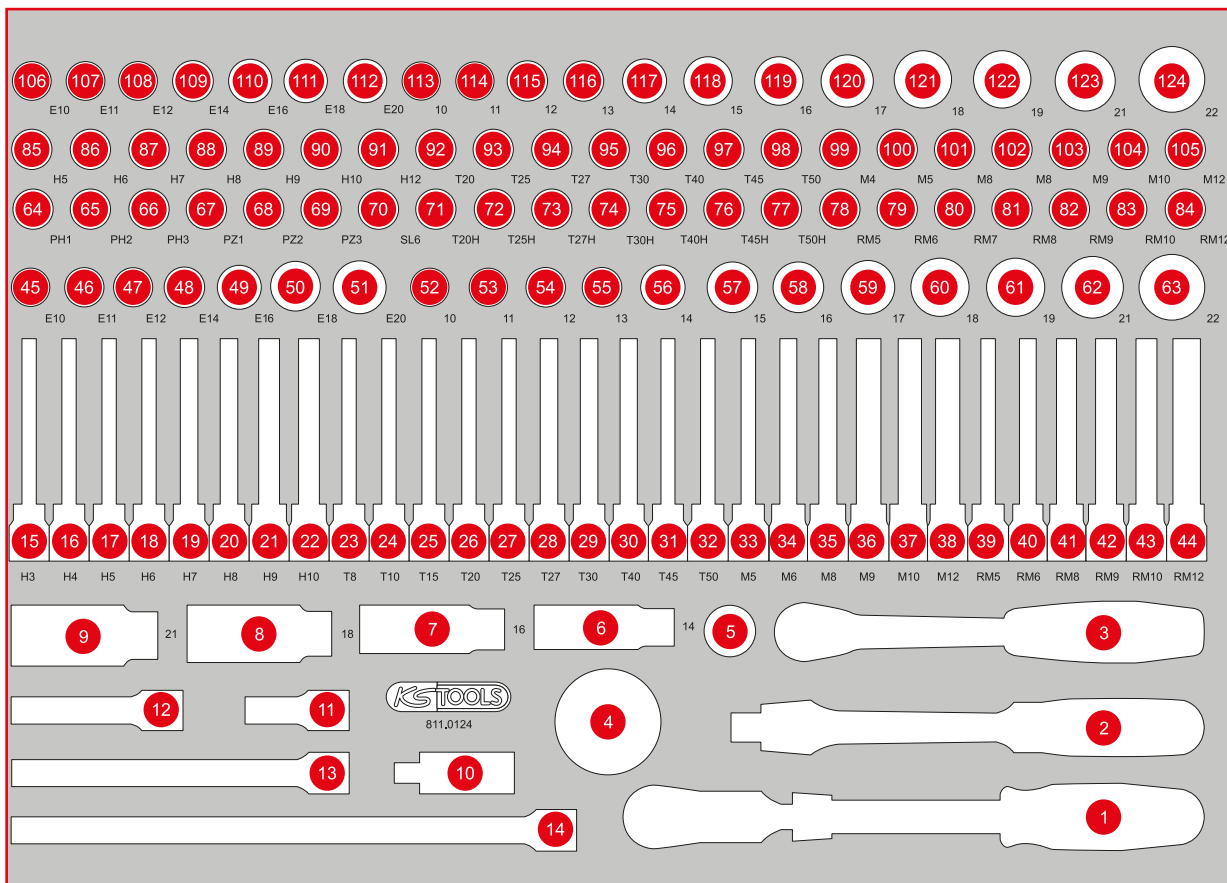

Pos.	Code	Description	pcs	Pos.	Code	Description	pcs	Pos.	Code	Description	pcs
65	911.3876	3/8" Bit socket, PH2	1	87	911.3867	3/8" Bit socket hexagon, 7 mm	1	109	911.4394	3/8" Torx E socket, E14, long	1
66	911.3877	3/8" Bit socket, PH3	1	88	911.3868	3/8" Bit socket hexagon, 8 mm	1	110	911.4396	3/8" Torx E socket, E16, long	1
67	911.3881	3/8" Bit socket, PZ1	1	89	917.3969	3/8" Bit socket hexagon, 9 mm	1	111	911.4398	3/8" Torx E socket, E18, long	1
68	911.3882	3/8" Bit socket, PZ2	1	90	917.3857	3/8" Bit socket hexagon, 10 mm	1	112	911.4399	3/8" Torx E socket, E20, long	1
69	911.3883	3/8" Bit socket, PZ3	1	91	911.3862	3/8" Bit socket hexagon, 12 mm	1	113	917.3830	3/8" Hexagonal socket, deep, 10 mm	1
70	911.3943	3/8" Bit socket slot 6 mm	1	92	911.3870	3/8" Bit socket Torx, T20	1	114	917.3831	3/8" Hexagonal socket, deep, 11 mm	1
71	911.3962	3/8" Bit socket Torx tamperproof, TB20	1	93	911.3871	3/8" Bit socket Torx, T25	1	115	917.3832	3/8" Hexagonal socket, deep, 12 mm	1
72	911.3963	3/8" Bit socket Torx tamperproof, TB25	1	94	911.3872	3/8" Bit socket Torx, T27	1	116	917.3833	3/8" Hexagonal socket, deep, 13 mm	1
73	911.3964	3/8" Bit socket Torx tamperproof, TB27	1	95	911.3873	3/8" Bit socket Torx, T30	1	117	917.3834	3/8" Hexagonal socket, deep, 14 mm	1
74	911.3965	3/8" Bit socket Torx tamperproof, TB30	1	96	911.3874	3/8" Bit socket Torx, T40	1	118	917.3835	3/8" Hexagonal socket, deep, 15 mm	1
75	911.3966	3/8" Bit socket Torx tamperproof, TB40	1	97	911.3885	3/8" Bit socket Torx, T45	1	119	917.3836	3/8" Hexagonal socket, deep, 16 mm	1
76	911.3967	3/8" Bit socket Torx tamperproof, TB45	1	98	911.3884	3/8" Bit socket Torx, T50	1	120	917.3837	3/8" Hexagonal socket, deep, 17 mm	1
77	911.3968	3/8" Bit socket Torx tamperproof, TB50	1	99	911.3918	3/8" Bit socket spline (XZN), M4	1	121	917.3838	3/8" Hexagonal socket, deep, 18 mm	1
78	917.3922	3/8" RIBE® Bit socket, M5	1	100	911.3915	3/8" Bit socket spline (XZN), M5	1	122	917.3839	3/8" Hexagonal socket, deep, 19 mm	1
79	917.3923	3/8" RIBE® Bit socket, M6	1	101	911.3916	3/8" Bit socket spline (XZN), M6	1	123	917.3841	3/8" Hexagonal socket, deep, 21 mm	1
80	917.3924	3/8" RIBE® Bit socket, M7	1	102	911.3917	3/8" Bit socket spline (XZN), M8	1	124	917.3842	3/8" Hexagonal socket, deep, 22 mm	1
81	917.3925	3/8" RIBE® Bit socket, M8	1	103	917.3901	3/8" Bit socket spline (XZN), M9	1				
82	917.3926	3/8" RIBE® Bit socket, M9	1	104	911.3920	3/8" Bit socket spline (XZN), M10	1				
83	917.3927	3/8" RIBE® Bit socket, M10	1	105	917.3903	3/8" Bit socket spline (XZN), M12	1				
84	917.3928	3/8" RIBE® Bit socket, M12	1	106	911.4390	3/8" Torx E socket, E10, long	1				
85	911.3865	3/8" Bit socket hexagon, 5 mm	1	107	911.4391	3/8" Torx E socket, E11, long	1				
86	911.3866	3/8" Bit socket hexagon, 6 mm	1	108	911.4392	3/8" Torx E socket, E12, long	1				

**M** 1/2" Socket spanner and screwdriver bit set

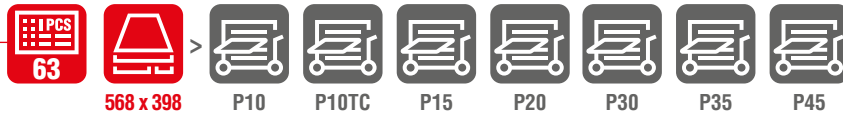

Pos.	Code	Description	pcs	Pos.	Code	Description	pcs	Pos.	Code	Description	pcs
1	917.1240	1/2" Hexagonal socket, deep, 10 mm	1	12	917.1259	1/2" Hexagonal socket, deep, 21 mm	1	23	911.4431	1/2" Torx E Socket, deep, E24	1
2	917.1241	1/2" Hexagonal socket, deep, 11 mm	1	13	917.1252	1/2" Hexagonal socket, deep, 22 mm	1	24	917.1337	1/2" Hexagonal socket, deep, 26 mm	1
3	917.1242	1/2" Hexagonal socket, deep, 12 mm	1	14	917.1315	1/2" Hexagonal socket, deep, 23 mm	1	25	917.1254	1/2" Hexagonal socket, deep, 27 mm	1
4	917.1243	1/2" Hexagonal socket, deep, 13 mm	1	15	917.1257	1/2" Hexagonal socket, deep, 24 mm	1	26	917.1338	1/2" Hexagonal socket, deep, 28 mm	1
5	917.1244	1/2" Hexagonal socket, deep, 14 mm	1	16	911.4423	1/2" Torx E Socket, 78 mm long, E10	1	27	917.1255	1/2" Hexagonal socket, deep, 30 mm	1
6	917.1245	1/2" Hexagonal socket, deep, 15 mm	1	17	911.4424	1/2" Torx E Socket, deep, E11	1	28	917.1256	1/2" Hexagonal socket, deep, 32 mm	1
7	917.1246	1/2" Hexagonal socket, deep, 16 mm	1	18	911.4425	1/2" Torx E Socket, 78 mm, E12	1	29	917.1296	1/2" Bit socket Torx tamperproof, long, TB30	1
8	917.1247	1/2" Hexagonal socket, deep, 17 mm	1	19	911.4426	1/2" Torx E Socket, 78 mm, E14	1	30	917.1297	1/2" Bit socket Torx tamperproof, long, TB40	1
9	917.1248	1/2" Hexagonal socket, deep, 18 mm	1	20	911.4427	1/2" Torx E Socket, 78 mm, E16	1	31	917.1298	1/2" Bit socket Torx tamperproof, long, TB45	1
10	917.1249	1/2" Hexagonal socket, deep, 19 mm	1	21	911.4428	1/2" Torx E Socket, 78 mm, E18	1	32	917.1299	1/2" Bit socket Torx tamperproof, long, TB50	1
11	917.1258	1/2" Hexagonal socket, deep, 20 mm	1	22	911.4429	1/2" Torx E Socket, 78 mm, E20	1	33	917.1251	1/2" Bit socket Torx tamperproof, long, TB55	1

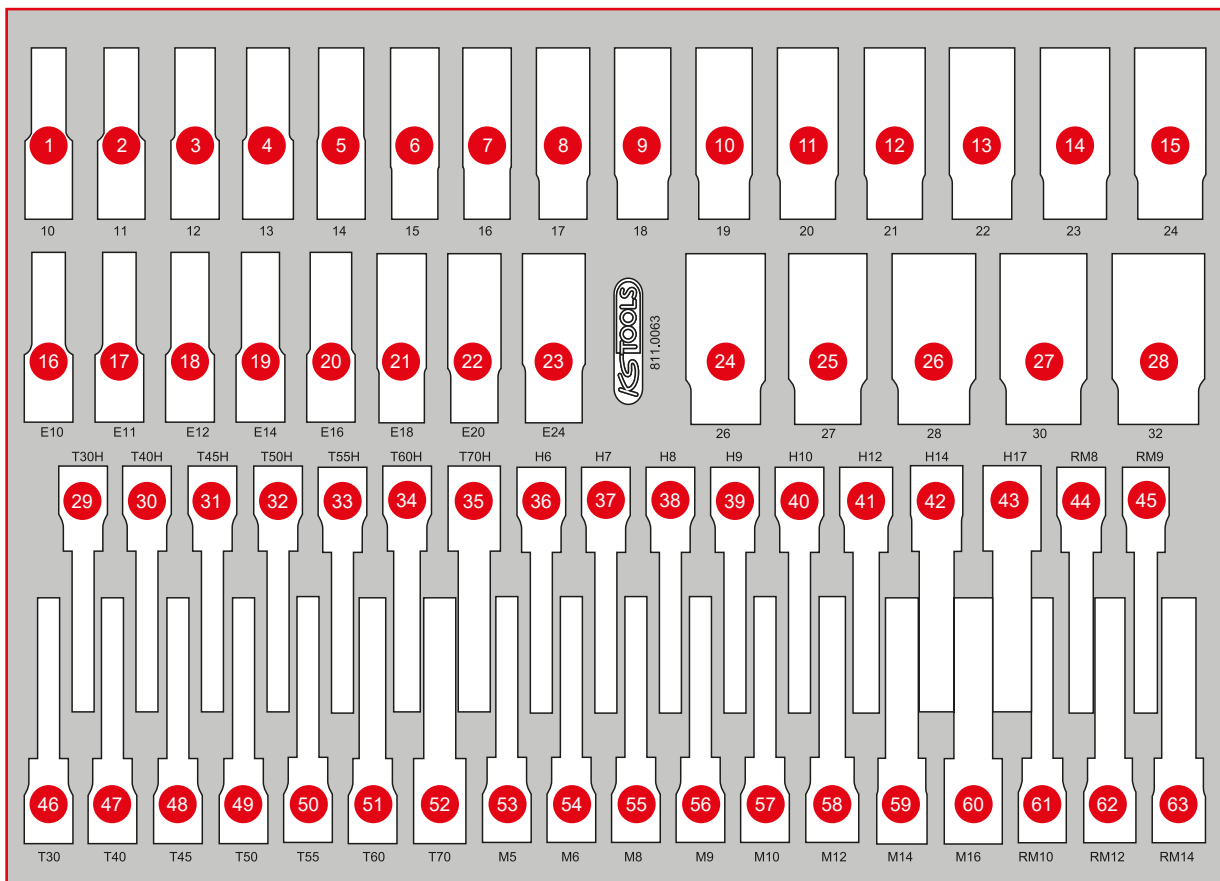

Pos.	Code	Description	pcs	Pos.	Code	Description	pcs	Pos.	Code	Description	pcs
34	917.1253	1/2" Bit socket Torx tamperproof, long, TB60	1	45	911.1925	1/2" Bit socket RIBE, M9, 110 mm	1	56	911.1359	1/2" Bit socket spline (XZN), M9, 110 mm	1
35	917.1304	1/2" Bit socket Torx tamperproof, long, TB70	1	46	911.1524	1/2" Bit socket Torx, long, T30	1	57	911.1353	1/2" Bit socket spline (XZN), M10, 110 mm	1
36	911.1326	1/2" Bit socket hexagon, long, 6 mm	1	47	911.1525	1/2" Bit socket Torx, long, T40	1	58	911.1354	1/2" Bit socket spline (XZN), M12, 110 mm	1
37	911.1327	1/2" Bit socket hexagon, long, 7 mm	1	48	911.1526	1/2" Bit socket Torx, long, T45	1	59	911.1355	1/2" Bit socket spline (XZN), M14, 110 mm	1
38	911.1328	1/2" Bit socket hexagon, long, 8 mm	1	49	911.1527	1/2" Bit socket Torx, long, T50	1	60	911.1356	1/2" Bit socket spline (XZN), M16, 110 mm	1
39	911.1329	1/2" Bit socket hexagon, long, 9 mm	1	50	911.1528	1/2" Bit socket Torx, long, T55	1	61	911.1926	1/2" Bit socket RIBE, M10, 110 mm	1
40	911.1330	1/2" Bit socket hexagon, long, 10 mm	1	51	911.1529	1/2" Bit socket Torx, long, T60	1	62	911.1995	1/2" Bit socket RIBE, M12, 110 mm	1
41	911.1332	1/2" Bit socket hexagon, long, 12 mm	1	52	911.1517	1/2" Bit socket Torx, long, T70	1	63	911.1997	1/2" Bit socket RIBE, M14, 110 mm	1
42	917.1332	1/2" Bit socket hexagon, long, 14 mm	1	53	911.1350	1/2" Bit socket spline (XZN), M5, 110 mm	1				
43	911.1337	1/2" Bit socket hexagon, long, 17 mm	1	54	911.1351	1/2" Bit socket spline (XZN), M6, 110 mm	1				
44	911.1924	1/2" Bit socket RIBE, M8, 110 mm	1	55	911.1352	1/2" Bit socket spline (XZN), M8, 110 mm	1				

811.0050

**M** Screw spanner set

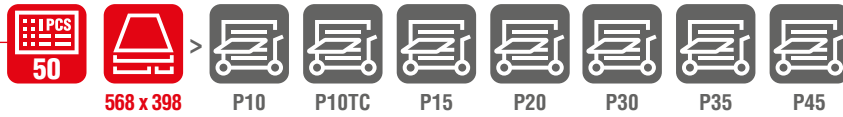

Pos.	Code	Description	pcs	Pos.	Code	Description	pcs	Pos.	Code	Description	pcs
1	517.0606	Combination spanners, offset, 6 mm	1	11	517.0623	Combination spanners, offset, 23 mm	1	21	503.4617	GEARplus reversing combination ratcheting spanner, 17 mm	1
2	517.0607	Combination spanners, offset, 7 mm	1	12	517.0622	Combination spanners, offset, 22 mm	1	22	503.4616	GEARplus reversing combination ratcheting spanner, 16 mm	1
3	517.0608	Combination spanners, offset, 8 mm	1	13	517.0621	Combination spanners, offset, 21 mm	1	23	503.4615	GEARplus reversing combination ratcheting spanner, 15 mm	1
4	517.0609	Combination spanners, offset, 9 mm	1	14	517.0620	Combination spanners, offset, 20 mm	1	24	503.4614	GEARplus reversing combination ratcheting spanner, 14 mm	1
5	517.0610	Combination spanners, offset, 10 mm	1	15	517.0619	Combination spanners, offset, 19 mm	1	25	503.4608	GEARplus reversing combination ratcheting spanner, 8 mm	1
6	517.0611	Combination spanners, offset, 11 mm	1	16	517.0618	Combination spanners, offset, 18 mm	1	26	503.4609	GEARplus reversing combination ratcheting spanner, 9 mm	1
7	517.0612	Combination spanners, offset, 12 mm	1	17	517.0617	Combination spanners, offset, 17 mm	1				
8	517.0613	Combination spanners, offset, 13 mm	1	18	517.0616	Combination spanners, offset, 16 mm	1				
9	517.0614	Combination spanners, offset, 14 mm	1	19	517.0615	Combination spanners, offset, 15 mm	1				
10	517.0624	Combination spanners, offset, 24 mm	1	20	503.4619	GEARplus reversing combination ratcheting spanner, 19 mm	1				

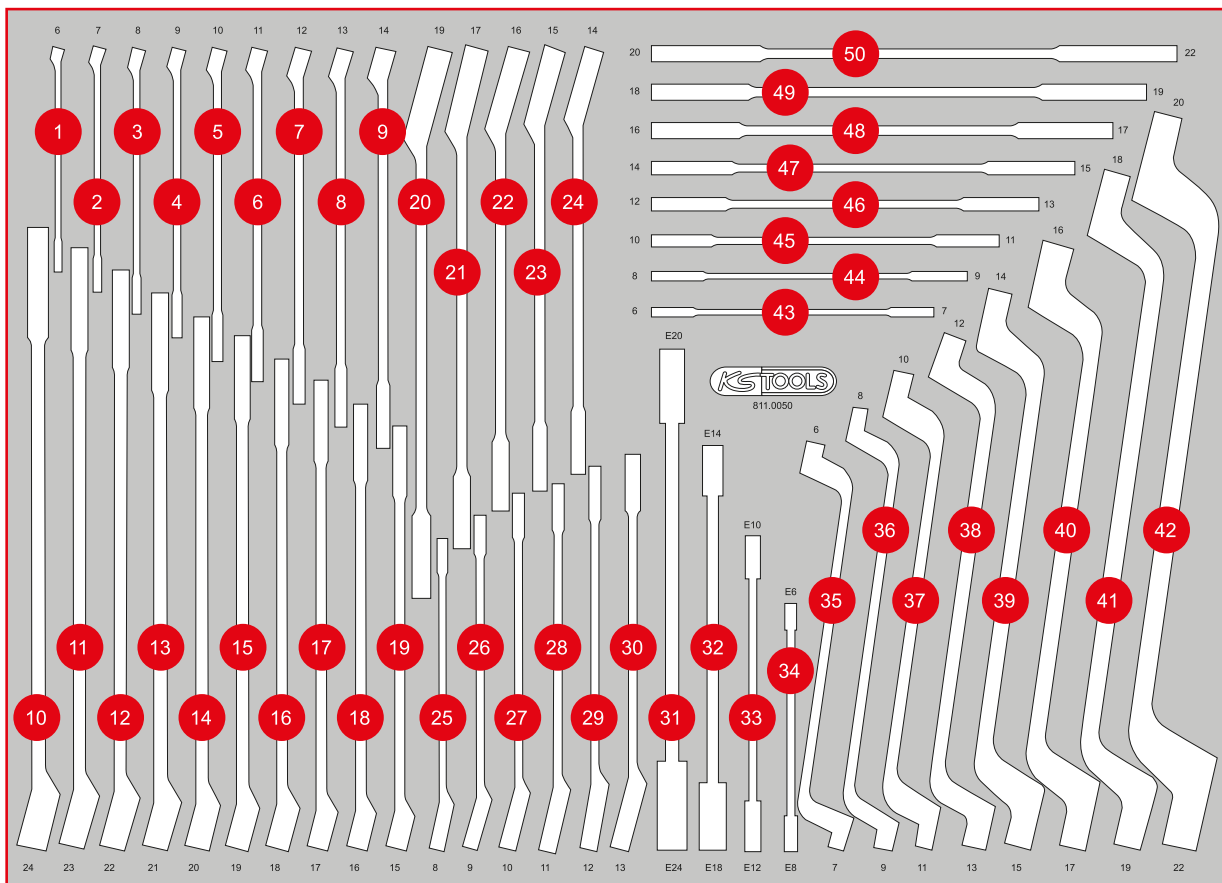

Pos.	Code	Description	pcs	Pos.	Code	Description	pcs	Pos.	Code	Description	pcs
27	503.4610	GEARplus reversing combination ratcheting spanner, 10 mm	1	33	911.0373	Double ring spanner for Torx E profile, E10 x E12	1	42	517.0813	Double ring spanner, offset, 20 x 22 mm	1
28	503.4611	GEARplus reversing combination ratcheting spanner, 11 mm	1	34	911.0371	Double ring spanner for Torx E profile, E6 x E8	1	43	517.0701	Double open ended spanners, 6 x 7 mm	1
29	503.4612	GEARplus reversing combination ratcheting spanner, 12 mm	1	35	517.0801	Double ring spanner, offset, 6 x 7 mm	1	44	517.0702	Double open ended spanners, 8 x 9 mm	1
30	503.4613	GEARplus reversing combination ratcheting spanner, 13 mm	1	36	517.0802	Double ring spanner, offset, 8 x 9 mm	1	45	517.0704	Double open ended spanners, 10 x 11 mm	1
31	911.0376	Double ring spanner for Torx E profile, E20 x E24	1	37	517.0804	Double ring spanner, offset, 10 x 11 mm	1	46	517.0707	Double open ended spanners, 12 x 13 mm	1
32	911.0374	Double ring spanner for Torx E profile, E14 x E18	1	38	517.0807	Double ring spanner, offset, 12 x 13 mm	1	47	517.0709	Double open ended spanners, 14 x 15 mm	1
				39	517.0809	Double ring spanner, offset, 14 x 15 mm	1	48	517.0710	Double open ended spanners, 16 x 17 mm	1
				40	517.0810	Double ring spanner, offset, 16 x 17 mm	1	49	517.0712	Double open ended spanners, 18 x 19 mm	1
				41	517.0812	Double ring spanner, offset, 18 x 19 mm	1	50	517.0714	Double open ended spanners, 20 x 22 mm	1



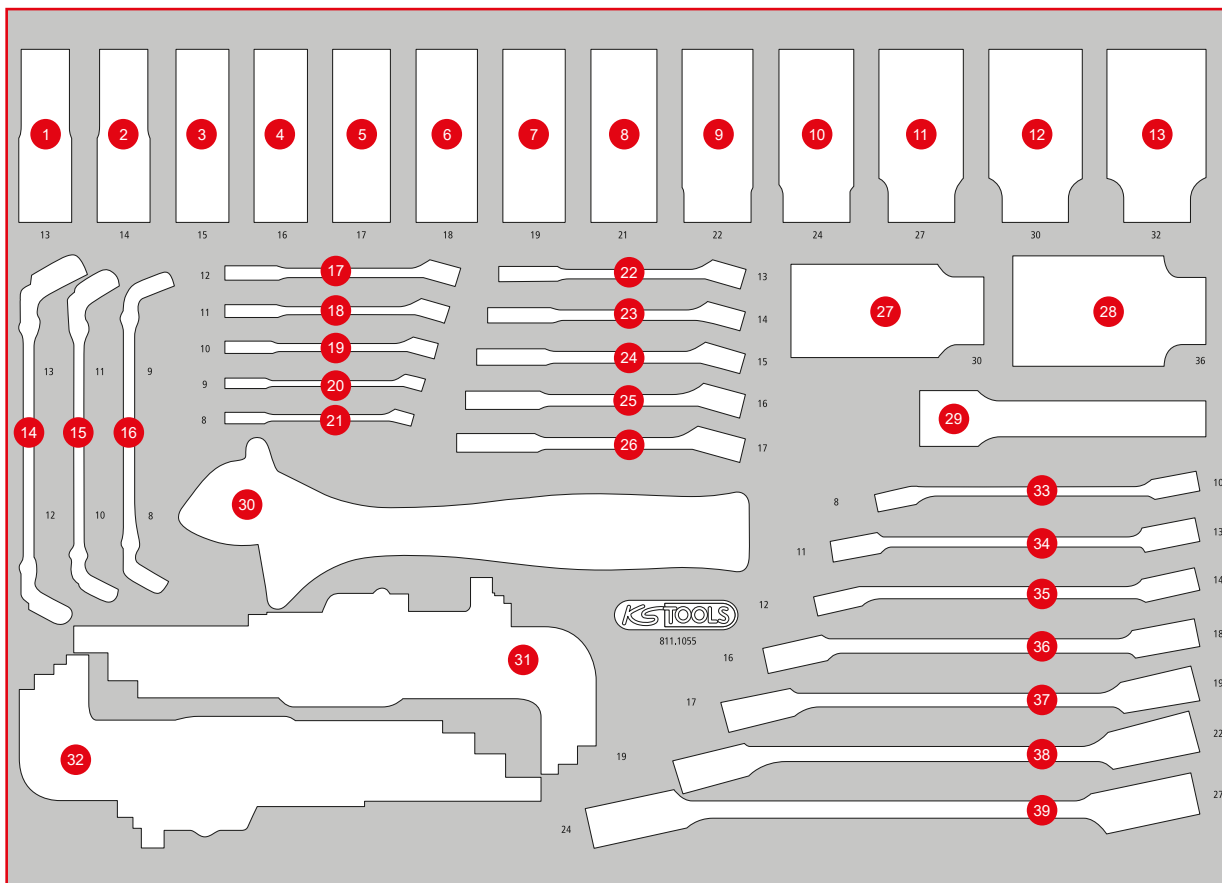

Pos.	Code	Description	pcs	Pos.	Code	Description	pcs	Pos.	Code	Description	pcs
21	518.0007	CHROMEplus Combination spanner, stubby, 8 mm	1	26	518.0017	CHROMEplus Combination spanner, stubby, 17 mm	1	32	151.5210	Ball head Torx angled socket wrench set, extra long, 9 pcs	9
22	518.0013	CHROMEplus Combination spanner, stubby, 13 mm	1	27	150.1705	Special drive shaft impact socket, 1/2", 30 mm	1	33	517.0252	Open double ring spanner, offset, 8 x 10 mm	1
23	518.0014	CHROMEplus Combination spanner, stubby, 14 mm	1	28	150.1707	Special drive shaft impact socket, 1/2", 36 mm	1	34	517.9244	Open double ring spanner, offset, 11 x 13 mm	1
24	518.0015	CHROMEplus Combination spanner, stubby, 15 mm	1	29	515.1135	1/2" Impact extension, 125 mm	1	35	517.0258	Open double ring spanner, offset, 12 x 14 mm	1
25	518.0016	CHROMEplus Combination spanner, stubby, 16 mm	1	30	577.0251	Adjustable spanner with dual component comfort grip handle, 28 mm	1	36	517.0263	Open double ring spanner, offset, 16 x 18 mm	1
				31	151.4420	Ball ended hexagon key wrench set, extra long, 9 pcs	9	37	517.0264	Open double ring spanner, offset, 17 x 19 mm	1
								38	517.0266	Open double ring spanner, offset, 19 x 22 mm	1
								39	517.0268	Open double ring spanner, offset, 24 x 27 mm	1

811.1032

**M** Screwdriver and spanner set

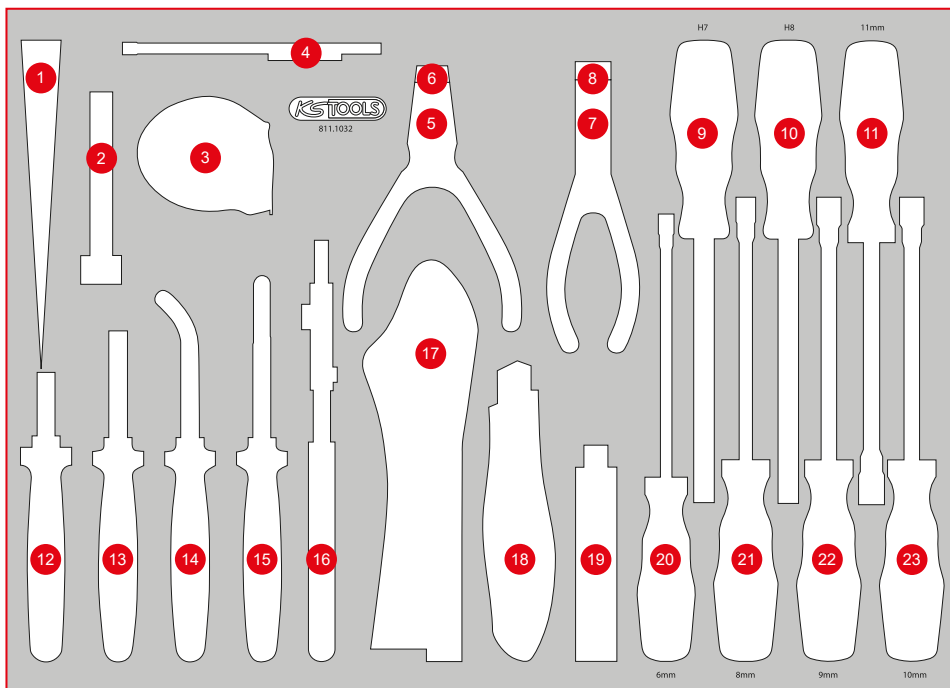
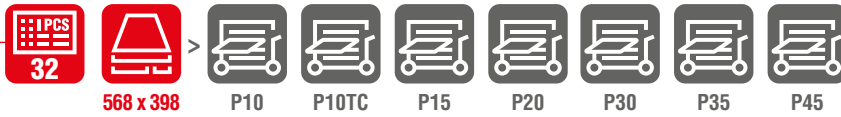

Pos.	Code	Description	pcs
1	911.8138	Trim plastic wedge, 195 x 3 0 mm	1
2	300.0600	Feeler gauge, 20 Blades, 0,05 - 1 mm	1
3	300.0114	Tape measure with locking device and belt clip, black red, 5 m, 19 mm	1
4	550.1001	2 in1 Telescopic solenoid holder with washer jet cleaning and setting tool, 150 - 675 mm	1
5	500.1029	Circlip pliers for external circlips, 160 mm	1
6	500.1026	Circlip pliers for external circlips, angled, 160 mm	1
7	500.1035	Circlip pliers for internal circlips, 160 mm	1
8	500.1032	Circlip pliers for internal circlips, angled, 160 mm	1
9	159.1127	ERGOTORQUEplus Socket screwdriver, 7 mm	1
10	911.1128	ERGOTORQUE Socket screwdriver, 8 mm	1
11	159.1209	ERGOTORQUEplus Socket screwdriver, 11 mm	1
12	115.1012	ERGOTORQUE diagonal side cutter, 160 mm	1
13	115.1021	ERGOTORQUE combination pliers, 180 mm	1
14	115.1019	ERGOTORQUE bent nose pliers serrated, 210 mm	1
15	115.1024	ERGOTORQUE long nose pliers serrated cutter, 200 mm	1
16	115.2010	Water pump pliers, 240 mm	1
17	115.1033	Self grip wrench, 220 mm	1
18	907.2135	Universal snap off blade knife 18 mm	1
19	907.2166	Snap off blades 0,5 x 18 x 100 mm, dispenser with 10 pieces	10
20	159.1204	ERGOTORQUEplus Socket screwdriver, 6 mm	1
21	159.1206	ERGOTORQUEplus Socket screwdriver, 8 mm	1
22	159.1207	ERGOTORQUEplus Socket screwdriver, 9 mm	1
23	159.1208	ERGOTORQUEplus Socket screwdriver, 10 mm	1

811.0021

**M** Hammer, chisel and file set



Pos.	Code	Description	pcs
1	140.5252	Recoil free soft faced Hammer, 400 g	1
2	142.1402	Fitters Hammer, fiberglas handle, 400 g	1
3	142.5101	Club Hammer, fiberglas handle, 1000 g	1
4	156.0242	Cross chisel, octagon, 7 mm	1
5	156.0234	Pin punch, Ø 6 mm, cylindrical shaft	1
6	156.0233	Pin punch, Ø 5 mm, cylindrical shaft	1
7	156.0232	Pin punch, cylindrical shaft, 4 mm	1
8	156.0231	Pin punch, cylindrical shaft, 3 mm	1
9	300.0510	Pocket vernier calliper 0-150 mm, 235 mm	1
10	157.0405	Tri-bastard file, form C, cut 2, 200 mm	1
11	157.0960	Brake saddle file, extra narrow, 270 mm	1
12	157.0205	Round file, form F, cut 2, 200 mm	1
13	156.0243	Centre punch, octagon 10 mm	1
14	156.0238	Punch, Ø 4 mm, conical	1
15	156.0237	Punch, Ø 3 mm, conical	1
16	156.0252	Flat chisel, octagon, 12 mm	1
17	156.0253	Flat chisel, octagon, 16 mm	1
18	156.0254	Flat chisel, octagon, 18 mm	1
19	156.0241	Flat chisel, octagon, 20 mm	1
20	201.2335	Steel wire brake saddle brush, 2-row, straight	1
21	300.0104	Flexible steel rule, 300 mm	1

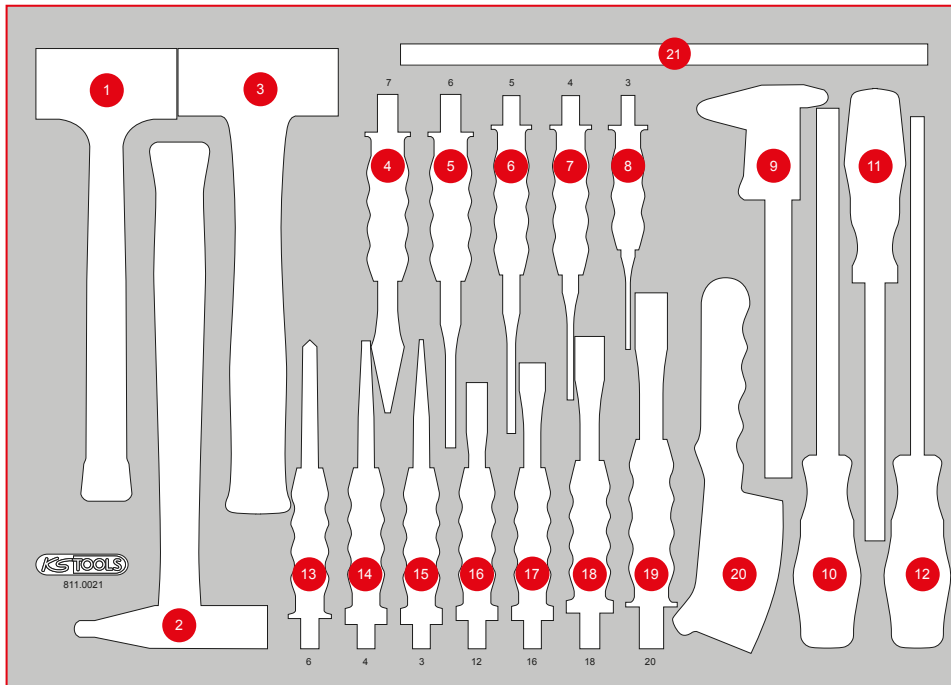

# P10

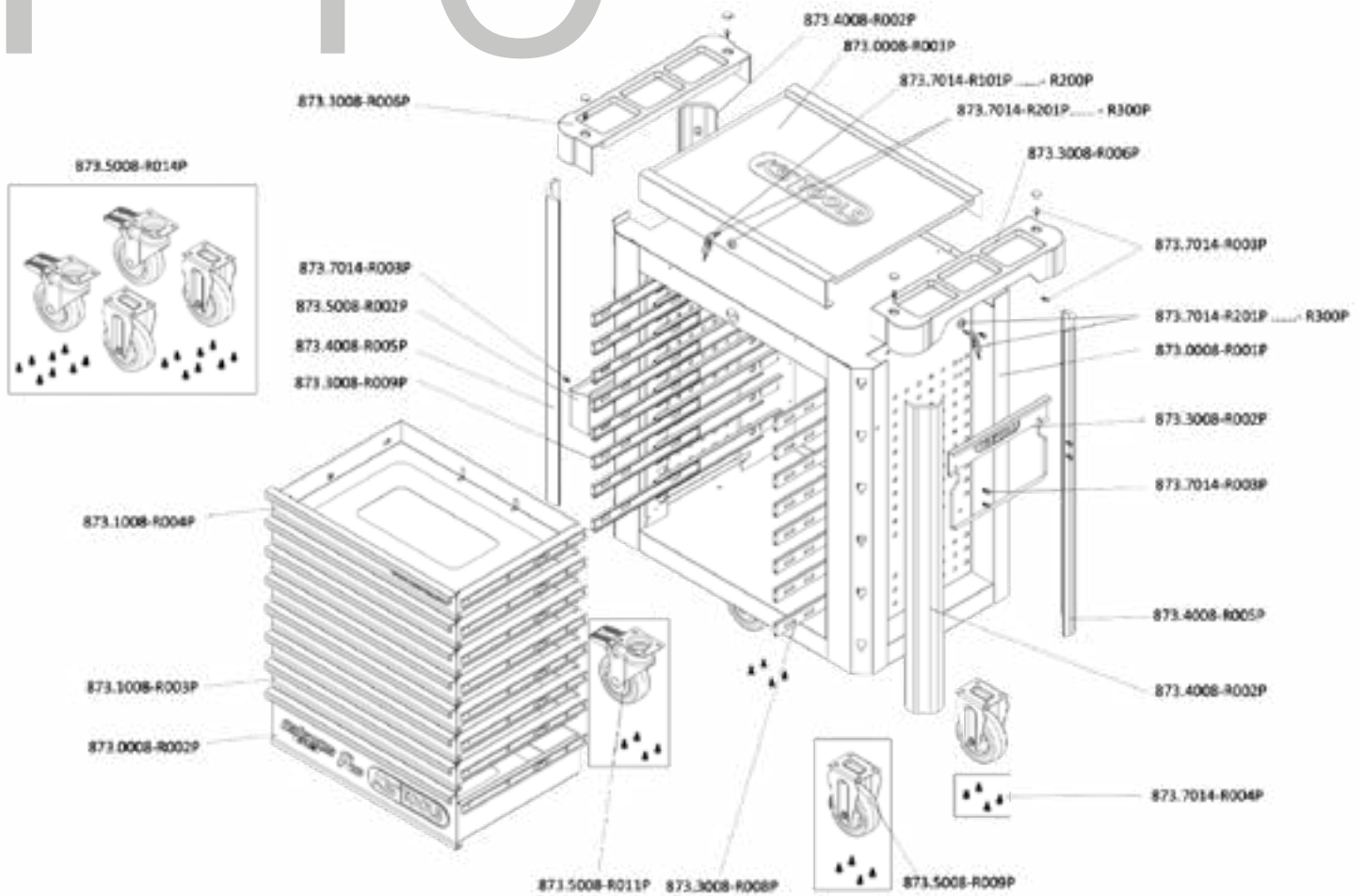

## INDIVIDUAL PARTS LIST

Item No.	Description	Amount
873.7014-R101P...	Replacement key for PERFORMANCEplus workshop trolley lock number xyz	2
873.7014-R201P...	Lock with 2 keys for PERFORMANCEplus workshop trolley lock number xyz	2
873.0008-R001P	Body with handle	1
873.0008-R002P	Compartment with logo and ball-bearing guide, 568x398x145 mm	1
873.0008-R003P	Stainless steel worktop	1
873.1008-R003P	Compartment with ball-bearing guide, for workshop trolley P10/P10TC/P15, 568x398x65 mm	6
873.1008-R004P	Compartment with website and ball-bearing guide, for workshop trolley P10/P15, 568x398x65 mm	1
873.3008-R002P	Paper roll holder for PERFORMANCEplus workshop trolley	1
873.3008-R006P	Storage for work surface	2
873.3008-R008P	Full extension (with ball-bearing guide) with automatic retraction	8
873.3008-R009P	Full extension (with ball-bearing guide) with automatic retraction	8
873.4008-R002P	Plastic bumpers	2
873.4008-R005P	Plastic bumpers	2
873.5008-R002P	Can holder for PERFORMANCEplus workshop trolley	1
873.5008-R009P	Fixed castors for PERFORMANCEplus workshop trolley, incl. screws	2
873.5008-R011P	Swivel castors with brakes, for PERFORMANCEplus workshop trolley, incl. screws	2
873.5008-R014P	Roller set for PERFORMANCEplus workshop trolley, incl. screws	1
873.7014-R003P	M6x12 screws for PERFORMANCEplus workshop trolley accessories	14
873.7014-R004P	M8 screws for PERFORMANCEplus workshop trolley rollers (16 pcs.)	1



**873.7014-R101P...R200P**  
Replacement key for lock number xyz



**873.7014-R201P...R300P**  
Lock with 2 keys for lock number xyz



**873.3008-R008P**  
Full extension (with ball-bearing guide) with automatic retraction, right



**873.3008-R009P**  
Full extension (with ball-bearing guide) with automatic retraction, left



**873.5008-R009P**  
Fixed castors, incl. screws



**873.5008-R011P**  
Swivel castors with brakes, incl. screws

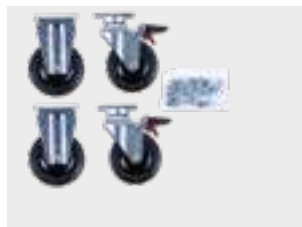

**873.5008-R014P**  
Roller set, incl. screws



**873.0008-R003P**  
Stainless steel work surface



**873.3008-R006P**  
Storage for work surface, including screw cover, usable on both sides



**873.1008-R004P**  
Compartment with website and ball-bearing guide, 568x398x65 mm



**873.1008-R003P**  
Compartment with ball-bearing guide, 568x398x65 mm



**873.0008-R002P**  
Compartment with logo and ball-bearing guide, 568x398x145 mm



**873.5008-R002P**  
Can holder, 310 mm



**873.3008-R002P**  
Paper roll holder, 320 mm



**873.4008-R005P**  
Plastic bumpers, front left, back right



**873.4008-R002P**  
Plastic bumpers, front right, back left



**873.7014-R004P**  
M8 screws (16 pcs.)



**873.7014-R003P**  
M6x12 screw (1 pcs.)



**873.0008-R001P**  
Body with handle



A thousand great parts for tough guys!

