

# P15

**workshop tool trolley**  
with 284 tools for 6 drawers  
**815.6284**

# THE COMPACT HEAVYWEIGHT

# P15



**Workshop trolley P15**  
with 8 compartments  
873.1008



**DUO Lock** Brilliant locking system



**Eight drawers** each load capacity up to 50 kg



Stable **ball bearing**



**Plastic Surface**

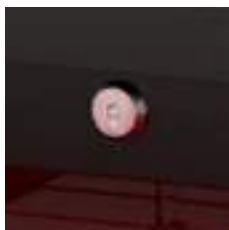

**Lock** lockable



**Anti-static castors** with brakes



Integrated **corner protection**



**Paper roll holder** included



**Can holder** included

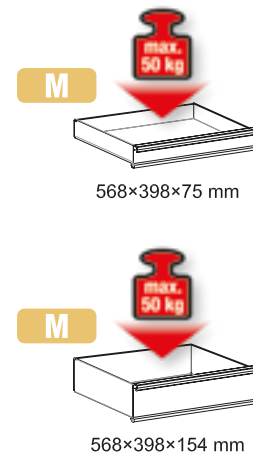
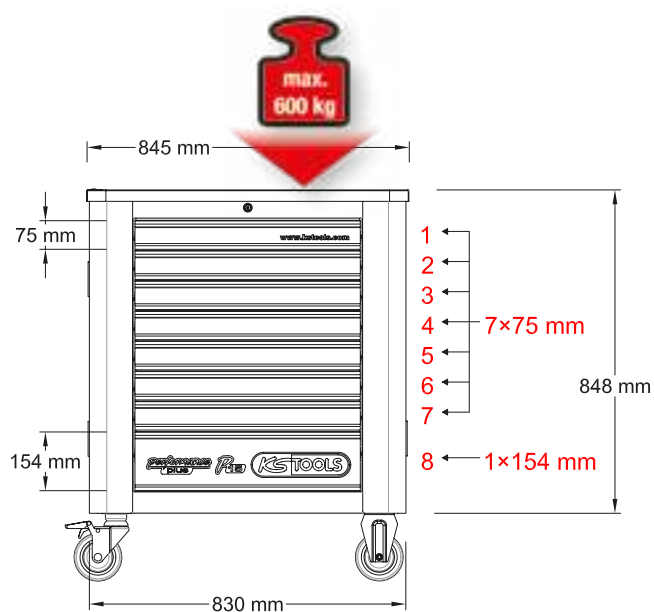

# P15 workshop tool trolley set with 284 tools for 6 drawers

815.6284



M

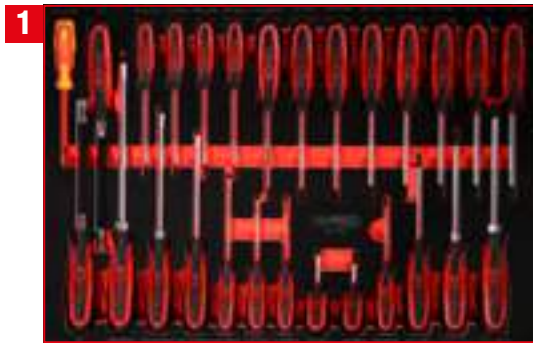

Screwdriver set in foam insert

811.0027

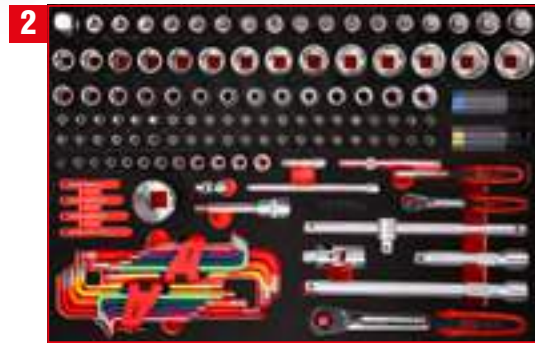

1/4" + 1/2" socket spanner set in foam insert

811.1137



Screw spanner set in foam insert

811.0046



Screw spanner set in foam insert

811.1024



Pliers and file set in foam insert

811.0019



Hammer and chisel set in foam insert

811.0022

811.0027

**M** Screwdriver set

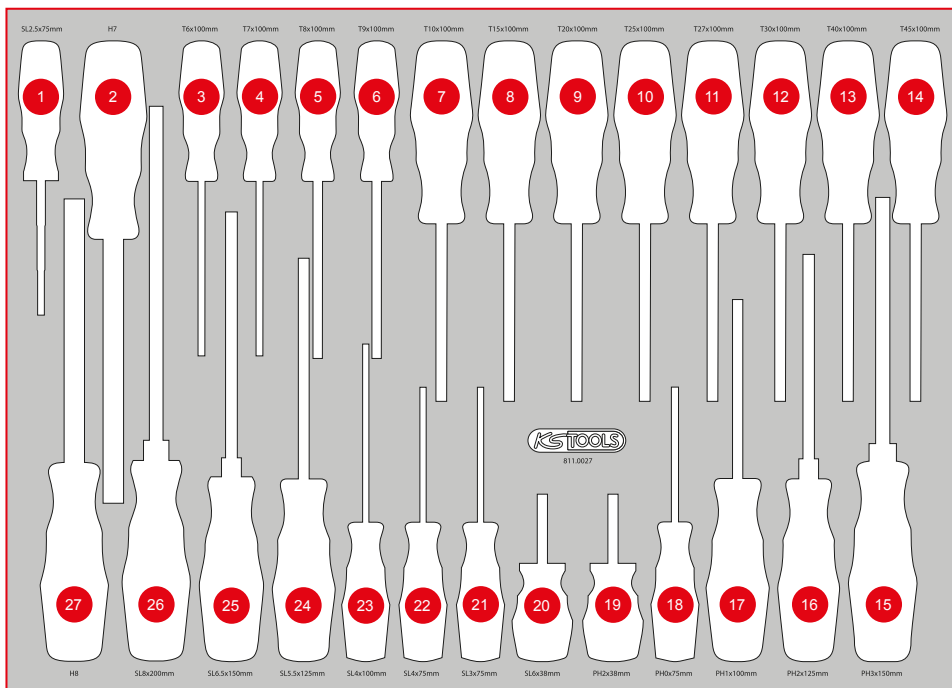
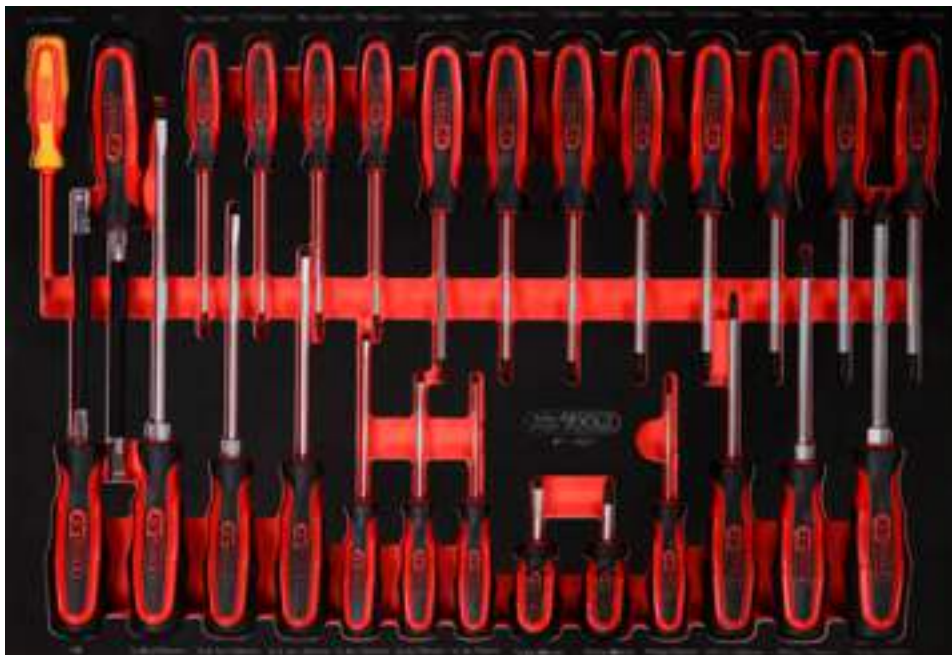

| Pos. | Code     | Description   | pcs |
|------|----------|---|-----|
| 1    | 117.0502 | ERGOTORQUE VDE slot screwdriver, 2,5 mm                       | 1   |
| 2    | 159.1127 | ERGOTORQUEplus Socket screwdriver, 7 mm                       | 1   |
| 3    | 159.1134 | ERGOTORQUEplus screwdriver, Torx, T6                          | 1   |
| 4    | 159.1135 | ERGOTORQUEplus screwdriver, Torx, T7                          | 1   |
| 5    | 159.1030 | ERGOTORQUEplus screwdriver, Torx, T8                          | 1   |
| 6    | 159.1031 | ERGOTORQUEplus screwdriver, Torx, T9                          | 1   |
| 7    | 159.1032 | ERGOTORQUEplus screwdriver, Torx, T10                         | 1   |
| 8    | 159.1033 | ERGOTORQUEplus screwdriver, Torx, T15                         | 1   |
| 9    | 159.1034 | ERGOTORQUEplus screwdriver, Torx, T20                         | 1   |
| 10   | 159.1035 | ERGOTORQUEplus screwdriver, Torx, T25                         | 1   |
| 11   | 159.1036 | ERGOTORQUEplus screwdriver, Torx, T27                         | 1   |
| 12   | 159.1037 | ERGOTORQUEplus screwdriver, Torx, T30                         | 1   |
| 13   | 159.1038 | ERGOTORQUEplus screwdriver, Torx, T40                         | 1   |
| 14   | 159.1136 | ERGOTORQUEplus screwdriver, Torx, T45                         | 1   |
| 15   | 159.2128 | ERGOTORQUEplus Socket screwdriver, 8 mm                       | 1   |
| 16   | 159.1011 | ERGOTORQUEplus screwdriver for slotted screws, 8 mm, 315 mm   | 1   |
| 17   | 159.1009 | ERGOTORQUEplus screwdriver for slotted screws, 6,5 mm, 255 mm | 1   |
| 18   | 159.1006 | ERGOTORQUEplus screwdriver for slotted screws, 5,5 mm, 230 mm | 1   |
| 19   | 159.1004 | ERGOTORQUEplus screwdriver for slotted screws, 4 mm, 180 mm   | 1   |
| 20   | 159.1003 | ERGOTORQUEplus screwdriver for slotted screws, 4 mm, 155 mm   | 1   |
| 21   | 159.1002 | ERGOTORQUEplus screwdriver for slotted screws, 3 mm, 155 mm   | 1   |
| 22   | 159.1001 | ERGOTORQUEplus screwdriver for slotted screws, 6 mm, stubby   | 1   |
| 23   | 159.1026 | ERGOTORQUEplus screwdriver for screws PH, PH2, stubby         | 1   |
| 24   | 159.1027 | ERGOTORQUEplus screwdriver for screws PH, PH0, 155 mm         | 1   |
| 25   | 159.1029 | ERGOTORQUEplus screwdriver for screws PH, PH1, 205 mm         | 1   |
| 26   | 159.1022 | ERGOTORQUEplus screwdriver for screws PH, PH2, 230 mm         | 1   |
| 27   | 159.1024 | ERGOTORQUEplus screwdriver for screws PH, PH3, 265 mm         | 1   |

811.1137

**M** 1/4" + 1/2" socket spanner set



| Pos. | Code     | Description                              | pcs | Pos. | Code     | Description                  | pcs | Pos. | Code     | Description                   | pcs |
|------|----------|--|-----|------|----------|------------------------------|-----|------|----------|-------------------------------|-----|
| 1    | 911.1234 | Adaptor, 1/2" F x 3/4" M                 | 1   | 22   | 917.1220 | 1/2" Hexagonal socket, 20 mm | 1   | 43   | 911.4322 | 1/2" Torx E Socket, E16       | 1   |
| 2    | 911.1341 | 1/2" Bit socket spline (XZN), M6, 55 mm  | 1   | 23   | 917.1221 | 1/2" Hexagonal socket, 21 mm | 1   | 44   | 911.4323 | 1/2" Torx E Socket, E18       | 1   |
| 3    | 911.1342 | 1/2" Bit socket spline (XZN), M8, 55 mm  | 1   | 24   | 917.1222 | 1/2" Hexagonal socket, 22 mm | 1   | 45   | 911.4324 | 1/2" Torx E Socket, E20       | 1   |
| 4    | 911.1343 | 1/2" Bit socket spline (XZN), M10, 55 mm | 1   | 25   | 917.1223 | 1/2" Hexagonal socket, 23 mm | 1   | 46   | 911.4326 | 1/2" Torx E Socket, E24       | 1   |
| 5    | 911.1365 | 1/2" Bit socket Torx, T40                | 1   | 26   | 917.1224 | 1/2" Hexagonal socket, 24 mm | 1   | 47   | 911.1436 | 1/4" Bit socket hexagon, 3 mm | 1   |
| 6    | 911.1366 | 1/2" Bit socket Torx, T45                | 1   | 27   | 917.1342 | 1/2" Hexagonal socket, 25 mm | 1   | 48   | 911.1437 | 1/4" Bit socket hexagon, 4 mm | 1   |
| 7    | 911.1367 | 1/2" Bit socket Torx, T50                | 1   | 28   | 917.1343 | 1/2" Hexagonal socket, 26 mm | 1   | 49   | 911.1438 | 1/4" Bit socket hexagon, 5 mm | 1   |
| 8    | 911.1368 | 1/2" Bit socket Torx, T55                | 1   | 29   | 917.1227 | 1/2" Hexagonal socket, 27 mm | 1   | 50   | 911.1439 | 1/4" Bit socket hexagon, 6 mm | 1   |
| 9    | 911.1369 | 1/2" Bit socket Torx, T60                | 1   | 30   | 917.1344 | 1/2" Hexagonal socket, 28 mm | 1   | 51   | 911.1440 | 1/4" Bit socket hexagon, 7 mm | 1   |
| 10   | 911.1305 | 1/2" Bit socket hexagon, short, 5 mm     | 1   | 31   | 917.1230 | 1/2" Hexagonal socket, 30 mm | 1   | 52   | 911.1441 | 1/4" Bit socket hexagon, 8 mm | 1   |
| 11   | 911.1306 | 1/2" Bit socket hexagon, short, 6 mm     | 1   | 32   | 917.1232 | 1/2" Hexagonal socket, 32 mm | 1   | 53   | 911.4407 | 1/4" Bit socket Torx, T6      | 1   |
| 12   | 911.1307 | 1/2" Bit socket hexagon, short, 7 mm     | 1   | 33   | 917.1216 | 1/2" Hexagonal socket, 16 mm | 1   | 54   | 911.4362 | 1/4" Bit socket Torx, T7      | 1   |
| 13   | 911.1308 | 1/2" Bit socket hexagon, short, 8 mm     | 1   | 34   | 917.1215 | 1/2" Hexagonal socket, 15 mm | 1   | 55   | 911.1448 | 1/4" Bit socket Torx, T8      | 1   |
| 14   | 911.1310 | 1/2" Bit socket hexagon, short, 10 mm    | 1   | 35   | 917.1214 | 1/2" Hexagonal socket, 14 mm | 1   | 56   | 911.1478 | 1/4" Bit socket Torx, T9      | 1   |
| 15   | 911.1312 | 1/2" Bit socket hexagon, short, 12 mm    | 1   | 36   | 917.1213 | 1/2" Hexagonal socket, 13 mm | 1   | 57   | 911.1442 | 1/4" Bit socket Torx, T10     | 1   |
| 16   | 911.1314 | 1/2" Bit socket hexagon, short, 14 mm    | 1   | 37   | 917.1212 | 1/2" Hexagonal socket, 12 mm | 1   | 58   | 911.1443 | 1/4" Bit socket Torx, T15     | 1   |
| 17   | 911.1317 | 1/2" Bit socket hexagon, short, 17 mm    | 1   | 38   | 917.1211 | 1/2" Hexagonal socket, 11 mm | 1   | 59   | 911.1444 | 1/4" Bit socket Torx, T20     | 1   |
| 18   | 911.1319 | 1/2" Bit socket hexagon, short, 19 mm    | 1   | 39   | 917.1210 | 1/2" Hexagonal socket, 10 mm | 1   | 60   | 911.1445 | 1/4" Bit socket Torx, T25     | 1   |
| 19   | 917.1217 | 1/2" Hexagonal socket, 17 mm             | 1   | 40   | 911.4334 | 1/2" Torx E Socket, E11      | 1   | 61   | 911.1449 | 1/4" Bit socket Torx, T27     | 1   |
| 20   | 917.1218 | 1/2" Hexagonal socket, 18 mm             | 1   | 41   | 911.4335 | 1/2" Torx E Socket, E12      | 1   | 62   | 911.1446 | 1/4" Bit socket Torx, T30     | 1   |
| 21   | 917.1219 | 1/2" Hexagonal socket, 19 mm             | 1   | 42   | 911.4336 | 1/2" Torx E Socket, E14      | 1   | 63   | 911.1447 | 1/4" Bit socket Torx, T40     | 1   |

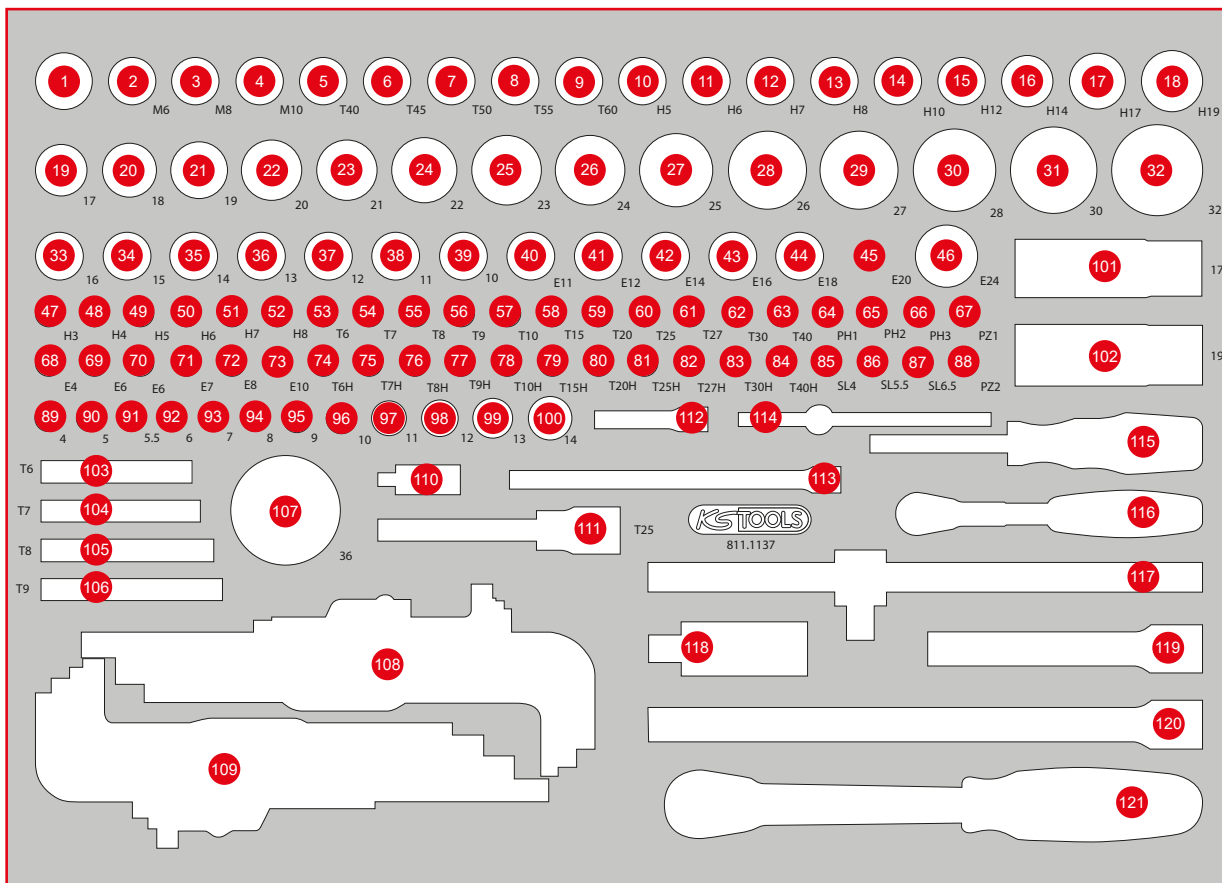

| Pos. | Code     | Description                            | pcs | Pos. | Code      | Description                                   | pcs | Pos. | Code     | Description   | pcs |
|------|----------|--|-----|------|-----------|---|-----|------|----------|---|-----|
| 64   | 911.1415 | 1/4" Bit socket, PH1                   | 1   | 85   | 911.1418  | 1/4" Bit socket slot, 4 mm                    | 1   | 106  | 151.2344 | Torx key wrench, short, T9                                      | 1   |
| 65   | 911.1416 | 1/4" Bit socket, PH2                   | 1   | 86   | 911.1419  | 1/4" Bit socket slot, 5,5 mm                  | 1   | 107  | 911.3548 | 3/4" 12 Point socket, short, 36 mm                              | 1   |
| 66   | 911.1417 | 1/4" Bit socket, PH3                   | 1   | 87   | 917.1421  | 1/4" Bit socket slot, 6,5 mm                  | 1   | 108  | 151.4530 | Ball ended Torx key wrench set, extra long and bent 108°, 9 pcs | 9   |
| 67   | 911.1401 | 1/4" Bit socket, PZ1                   | 1   | 88   | 911.1402  | 1/4" Bit socket, PZ2                          | 1   | 109  | 151.4420 | Ball ended hexagon key wrench set, extra long, 9 pcs            | 9   |
| 68   | 911.4313 | 1/4" Torx E Socket, E4                 | 1   | 89   | 917.1404  | 1/4" Hexagonal socket, 4 mm                   | 1   | 110  | 911.1450 | 1/4" Universal joint  | 1   |
| 69   | 911.4314 | 1/4" Torx E Socket, E5                 | 1   | 90   | 917.1405  | 1/4" Hexagonal socket, 5 mm                   | 1   | 111  | 918.1643 | 1/2" CHROMEplus Bit socket Torx, long, T25                      | 1   |
| 70   | 911.4315 | 1/4" Torx E Socket, E6                 | 1   | 91   | 917.14055 | 1/4" Hexagonal socket, 5,5 mm                 | 1   | 112  | 911.1423 | 1/4" Extension with hexagon drive, 50 mm                        | 1   |
| 71   | 911.4316 | 1/4" Torx E Socket, E7                 | 1   | 92   | 917.1406  | 1/4" Hexagonal socket, 6 mm                   | 1   | 113  | 911.1451 | 1/4" Extension with hexagon drive, 150 mm                       | 1   |
| 72   | 911.4317 | 1/4" Torx E Socket, E8                 | 1   | 93   | 917.1407  | 1/4" Hexagonal socket, 7 mm                   | 1   | 114  | 911.1425 | Sliding T-bar, 1/4", 110 mm                                     | 1   |
| 73   | 911.4332 | 1/4" Torx E Socket, E10                | 1   | 94   | 917.1408  | 1/4" Hexagonal socket, 8 mm                   | 1   | 115  | 911.1434 | 1/4" Square drive screwdriver, 150 mm                           | 1   |
| 74   | 917.1456 | 1/4" Bit socket Torx tamperproof, TB6  | 1   | 95   | 917.1409  | 1/4" Hexagonal socket, 9 mm                   | 1   | 116  | 920.1490 | 1/4" SlimPOWER Reversible ratchet, 72 teeth                     | 1   |
| 75   | 917.1457 | 1/4" Bit socket Torx tamperproof, TB7  | 1   | 96   | 917.1410  | 1/4" Hexagonal socket, 10 mm                  | 1   | 117  | 911.1204 | Sliding T-bar, 1/2", 250 mm                                     | 1   |
| 76   | 911.1461 | 1/4" Bit socket Torx tamperproof, TB8  | 1   | 97   | 917.1411  | 1/4" Hexagonal socket, 11 mm                  | 1   | 118  | 911.1250 | 1/2" Universal joint  | 1   |
| 77   | 911.1485 | 1/4" Bit socket Torx tamperproof, TB9  | 1   | 98   | 917.1412  | 1/4" Hexagonal socket, 12 mm                  | 1   | 119  | 911.1202 | 1/2" Extensions, 125 mm   | 1   |
| 78   | 911.1462 | 1/4" Bit socket Torx tamperproof, TB10 | 1   | 99   | 917.1413  | 1/4" Hexagonal socket, 13 mm                  | 1   | 120  | 911.1203 | 1/2" Extensions, 250 mm   | 1   |
| 79   | 911.1463 | 1/4" Bit socket Torx tamperproof, TB15 | 1   | 100  | 917.1414  | 1/4" Hexagonal socket, 14 mm                  | 1   | 121  | 920.1290 | 1/2" SlimPOWER Reversible ratchet, 72 teeth                     | 1   |
| 80   | 911.1464 | 1/4" Bit socket Torx tamperproof, TB20 | 1   | 101  | 515.0992  | SlimPOWER 1/2" Alloy rim impact socket, 17 mm | 1   |      |          |   |     |
| 81   | 911.1465 | 1/4" Bit socket Torx tamperproof, TB25 | 1   | 102  | 515.0993  | SlimPOWER 1/2" Alloy rim impact socket, 19 mm | 1   |      |          |   |     |
| 82   | 911.1466 | 1/4" Bit socket Torx tamperproof, TB27 | 1   | 103  | 151.2341  | Torx key wrench, short, T6                    | 1   |      |          |   |     |
| 83   | 911.1467 | 1/4" Bit socket Torx tamperproof, TB30 | 1   | 104  | 151.2342  | Torx key wrench, short, T7                    | 1   |      |          |   |     |
| 84   | 911.1468 | 1/4" Bit socket Torx tamperproof, TB40 | 1   | 105  | 151.2343  | Torx key wrench, short, T8                    | 1   |      |          |   |     |

811.0046

**M** Screw spanner set



| Pos. | Code     | Description                         | pcs | Pos. | Code     | Description                         | pcs | Pos. | Code     | Description                                       | pcs |
|------|----------|-------------------------------------|-----|------|----------|-------------------------------------|-----|------|----------|---|-----|
| 1    | 517.0606 | Combination spanners, offset, 6 mm  | 1   | 10   | 517.0615 | Combination spanners, offset, 15 mm | 1   | 19   | 911.0371 | Double ring spanner for Torx E profile, E6 x E8   | 1   |
| 2    | 517.0607 | Combination spanners, offset, 7 mm  | 1   | 11   | 517.0616 | Combination spanners, offset, 16 mm | 1   | 20   | 911.0373 | Double ring spanner for Torx E profile, E10 x E12 | 1   |
| 3    | 517.0608 | Combination spanners, offset, 8 mm  | 1   | 12   | 517.0617 | Combination spanners, offset, 17 mm | 1   | 21   | 911.0374 | Double ring spanner for Torx E profile, E14 x E18 | 1   |
| 4    | 517.0609 | Combination spanners, offset, 9 mm  | 1   | 13   | 517.0618 | Combination spanners, offset, 18 mm | 1   | 22   | 911.0376 | Double ring spanner for Torx E profile, E20 x E24 | 1   |
| 5    | 517.0610 | Combination spanners, offset, 10 mm | 1   | 14   | 517.0619 | Combination spanners, offset, 19 mm | 1   | 23   | 920.0406 | ULTIMATEplus Double ring ended spanner, 6 x 7 mm  | 1   |
| 6    | 517.0611 | Combination spanners, offset, 11 mm | 1   | 15   | 517.0621 | Combination spanners, offset, 21 mm | 1   | 24   | 920.0408 | ULTIMATEplus Double ring ended spanner, 8 x 9 mm  | 1   |
| 7    | 517.0612 | Combination spanners, offset, 12 mm | 1   | 16   | 517.0622 | Combination spanners, offset, 22 mm | 1   |      |          |   |     |
| 8    | 517.0613 | Combination spanners, offset, 13 mm | 1   | 17   | 517.0624 | Combination spanners, offset, 24 mm | 1   |      |          |   |     |
| 9    | 517.0614 | Combination spanners, offset, 14 mm | 1   | 18   | 517.0627 | Combination spanners, offset, 27 mm | 1   |      |          |   |     |

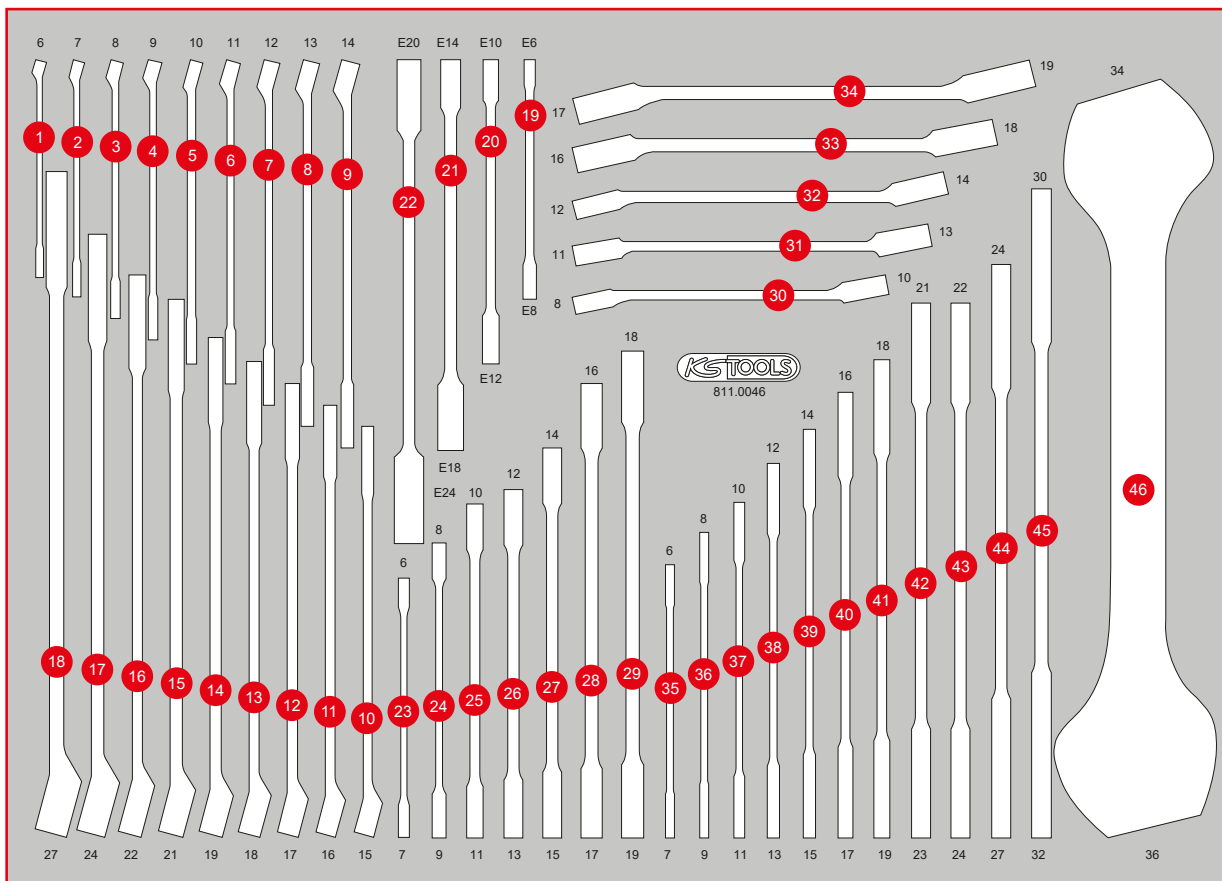

| Pos. | Code     | Description  | pcs | Pos. | Code     | Description                                  | pcs | Pos. | Code     | Description                            | pcs |
|------|----------|--|-----|------|----------|--|-----|------|----------|--|-----|
| 25   | 920.0410 | ULTIMATEplus Double ring ended spanner, 10 x 11 mm | 1   | 30   | 517.0252 | Open double ring spanner, offset, 8 x 10 mm  | 1   | 39   | 517.0709 | Double open ended spanners, 14 x 15 mm | 1   |
| 26   | 920.0412 | ULTIMATEplus Double ring ended spanner, 12 x 13 mm | 1   | 31   | 517.9244 | Open double ring spanner, offset, 11 x 13 mm | 1   | 40   | 517.0710 | Double open ended spanners, 16 x 17 mm | 1   |
| 27   | 920.0414 | ULTIMATEplus Double ring ended spanner, 14 x 15 mm | 1   | 32   | 517.0258 | Open double ring spanner, offset, 12 x 14 mm | 1   | 41   | 517.0712 | Double open ended spanners, 18 x 19 mm | 1   |
| 28   | 920.0416 | ULTIMATEplus Double ring ended spanner, 16 x 17 mm | 1   | 33   | 517.0263 | Open double ring spanner, offset, 16 x 18 mm | 1   | 42   | 517.0715 | Double open ended spanners, 21 x 23 mm | 1   |
| 29   | 920.0418 | ULTIMATEplus Double ring ended spanner, 18 x 19 mm | 1   | 34   | 517.0264 | Open double ring spanner, offset, 17 x 19 mm | 1   | 43   | 517.0736 | Double open ended spanners, 22 x 24 mm | 1   |
|      |          |  |     | 35   | 517.0701 | Double open ended spanners, 6 x 7 mm         | 1   | 44   | 517.0716 | Double open ended spanners, 24 x 27 mm | 1   |
|      |          |  |     | 36   | 517.0702 | Double open ended spanners, 8 x 9 mm         | 1   | 45   | 517.0718 | Double open ended spanners, 30 x 32 mm | 1   |
|      |          |  |     | 37   | 517.0704 | Double open ended spanners, 10 x 11 mm       | 1   | 46   | 517.0773 | Double open ended spanners, 34 x 36 mm | 1   |
|      |          |  |     | 38   | 517.0707 | Double open ended spanners, 12 x 13 mm       | 1   |      |          |  |     |

811.1024

**M** Screw spanner set

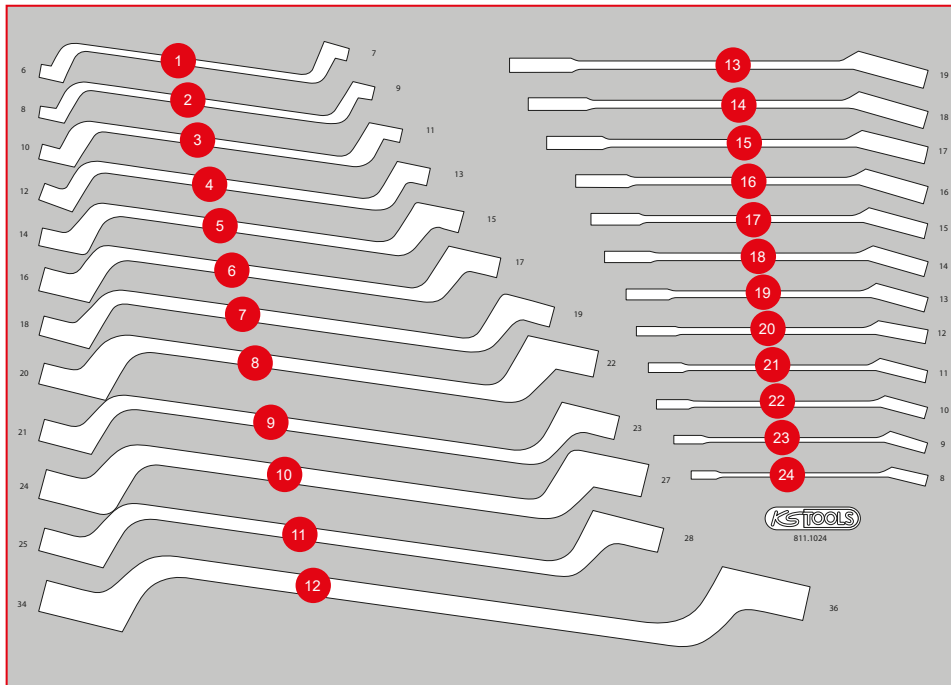
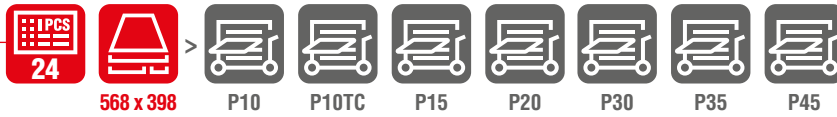

| Pos. | Code     | Description  | pcs |
|------|----------|--|-----|
| 1    | 517.0801 | Double ring spanner, offset, 6 x 7 mm                    | 1   |
| 2    | 517.0802 | Double ring spanner, offset, 8 x 9 mm                    | 1   |
| 3    | 517.0804 | Double ring spanner, offset, 10 x 11 mm                  | 1   |
| 4    | 517.0807 | Double ring spanner, offset, 12 x 13 mm                  | 1   |
| 5    | 517.0809 | Double ring spanner, offset, 14 x 15 mm                  | 1   |
| 6    | 517.0810 | Double ring spanner, offset, 16 x 17 mm                  | 1   |
| 7    | 517.0812 | Double ring spanner, offset, 18 x 19 mm                  | 1   |
| 8    | 517.0813 | Double ring spanner, offset, 20 x 22 mm                  | 1   |
| 9    | 517.0815 | Double ring spanner, offset, 21 x 23 mm                  | 1   |
| 10   | 517.0816 | Double ring spanner, offset, 24 x 27 mm                  | 1   |
| 11   | 517.0857 | Double ring spanner, offset, 25 x 28 mm                  | 1   |
| 12   | 517.0818 | Double ring spanner, offset, 30 x 32 mm                  | 1   |
| 13   | 503.4619 | GEARplus reversing combination ratcheting spanner, 19 mm | 1   |
| 14   | 503.4618 | GEARplus reversing combination ratcheting spanner, 18 mm | 1   |
| 15   | 503.4617 | GEARplus reversing combination ratcheting spanner, 17 mm | 1   |
| 16   | 503.4616 | GEARplus reversing combination ratcheting spanner, 16 mm | 1   |
| 17   | 503.4615 | GEARplus reversing combination ratcheting spanner, 15 mm | 1   |
| 18   | 503.4614 | GEARplus reversing combination ratcheting spanner, 14 mm | 1   |
| 19   | 503.4613 | GEARplus reversing combination ratcheting spanner, 13 mm | 1   |
| 20   | 503.4612 | GEARplus reversing combination ratcheting spanner, 12 mm | 1   |
| 21   | 503.4611 | GEARplus reversing combination ratcheting spanner, 11 mm | 1   |
| 22   | 503.4610 | GEARplus reversing combination ratcheting spanner, 10 mm | 1   |
| 23   | 503.4609 | GEARplus reversing combination ratcheting spanner, 9 mm  | 1   |
| 24   | 503.4608 | GEARplus reversing combination ratcheting spanner, 8 mm  | 1   |

811.0019

**M** Pliers and file set



| Pos. | Code     | Description   | pcs |
|------|----------|---|-----|
| 1    | 157.0405 | Tri-bastard file, form C, cut 2, 200 mm                               | 1   |
| 2    | 157.0105 | Halfround file, form E, cut 2, 20 mm                                  | 1   |
| 3    | 157.0005 | Flat file, form B, cut 2, 200 mm                                      | 1   |
| 4    | 157.0205 | Round file, form F, cut 2, 200 mm                                     | 1   |
| 5    | 907.2166 | Snap off blades 0,5 x1 8 x 100 mm, dispenser with 10 pieces           | 10  |
| 6    | 300.0114 | Tape measure with locking device and belt clip, black red, 5 m, 19 mm | 1   |
| 7    | 300.0510 | Pocket vernier calliper 0-150 mm, 235 mm                              | 1   |
| 8    | 300.0600 | Feeler gauge, 20 Blades, 0,05-1 mm                                    | 1   |
| 9    | 907.2135 | Universal snap off blade knife 18 mm                                  | 1   |
| 10   | 115.1033 | Self grip wrench, 220 mm  | 1   |
| 11   | 115.2010 | Water pump pliers, 240 mm   | 1   |
| 12   | 500.1026 | Circlip pliers for external circlips, angled, 160 mm                  | 1   |
| 13   | 500.1029 | Circlip pliers for external circlips, 160 mm                          | 1   |
| 14   | 500.1032 | Circlip pliers for internal circlips, angled, 160 mm                  | 1   |
| 15   | 500.1035 | Circlip pliers for internal circlips, 160 mm                          | 1   |
| 16   | 115.1012 | ERGOTORQUE diagonal side cutter, 160 mm                               | 1   |
| 17   | 115.1021 | ERGOTORQUE combination pliers, 180 mm                                 | 1   |
| 18   | 115.1019 | ERGOTORQUE bent nose pliers serrated, 210 mm                          | 1   |
| 19   | 115.1024 | ERGOTORQUE long nose pliers serrated cutter, 200 mm                   | 1   |

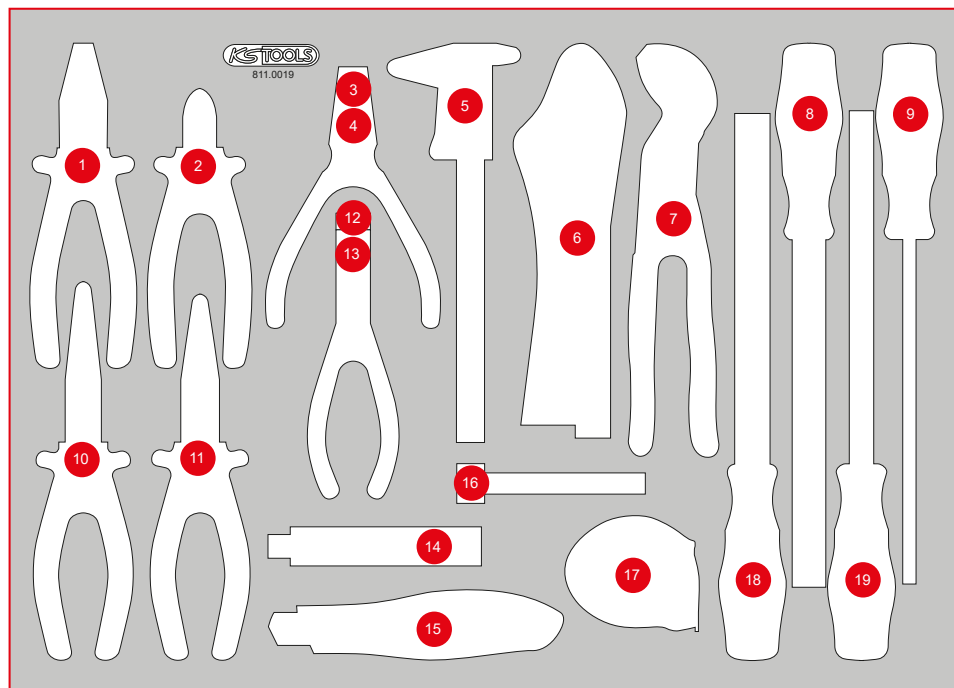

811.0022

**M** Hammer and chisel set



| Pos. | Code     | Description   | pcs |
|------|----------|---|-----|
| 1    | 911.8138 | Trim plastic wedge, 195 x 30 mm   | 1   |
| 2    | 140.5252 | Recoil free soft faced Hammer, 400 g  | 1   |
| 3    | 142.1402 | Fitters Hammer, fiberglas handle, 400 g   | 1   |
| 4    | 142.5101 | Club Hammer, fiberglas handle, 1000 g   | 1   |
| 5    | 550.1025 | Flexible magnet lifter, 510 mm, Øhead=15 mm   | 1   |
| 6    | 550.1001 | 2in1 Telescopic solenoid holder with washer jet cleaning and setting tool, 150 - 675 mm | 1   |
| 7    | 150.4370 | perfectLight torch 85 lumen   | 1   |
| 8    | 911.8146 | Tyre lever, 370 mm  | 1   |
| 9    | 201.2335 | Steel wire brake saddle brush, 2-row, straight 225 mm                                   | 1   |
| 10   | 156.0241 | Flat chisel, octagon, 20 mm   | 1   |
| 11   | 156.0254 | Flat chisel, octagon, 18 mm   | 1   |
| 12   | 156.0242 | Cross chisel, octagon, 7 mm   | 1   |
| 13   | 156.0243 | Centre punch, octagon 10 mm   | 1   |
| 14   | 156.0244 | Punch, Ø 5 mm, conical  | 1   |
| 15   | 156.0238 | Punch, Ø 4 mm, conical  | 1   |
| 16   | 156.0237 | Punch, Ø 3 mm, conical  | 1   |
| 17   | 156.0231 | Pin punch, Ø 3 mm, cylindrical shaft  | 1   |
| 18   | 156.0232 | Pin punch, Ø 4 mm, cylindrical shaft  | 1   |
| 19   | 156.0233 | Pin punch, Ø 5 mm, cylindrical shaft  | 1   |
| 20   | 156.0234 | Pin punch, Ø 6 mm, cylindrical shaft  | 1   |
| 21   | 156.0235 | Pin punch, Ø 8 mm, cylindrical shaft  | 1   |
| 22   | 907.2232 | Gasket scraper, 25 x 200 mm   | 1   |

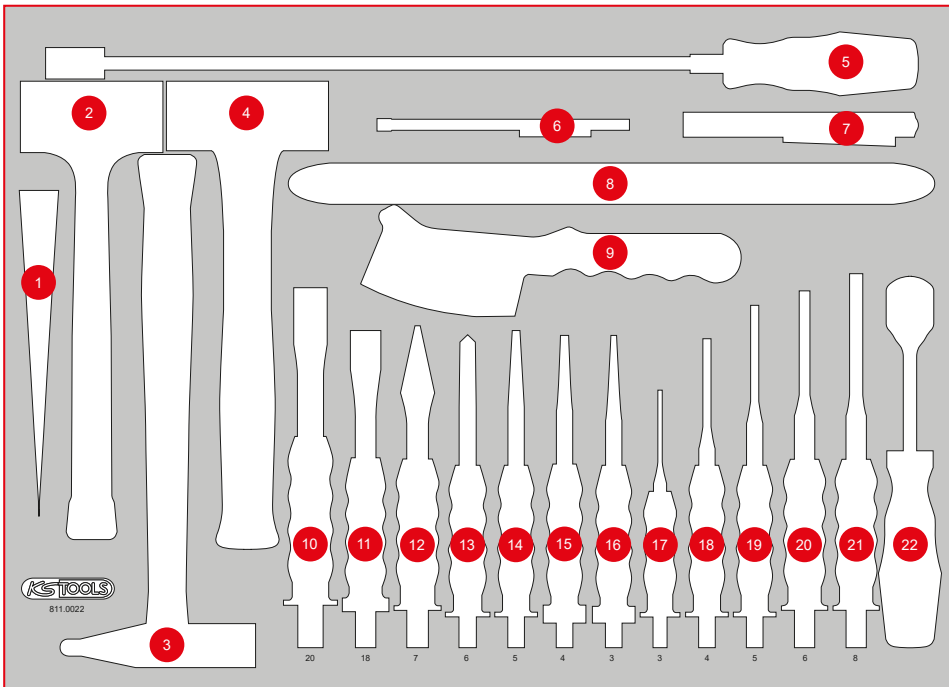

# P15

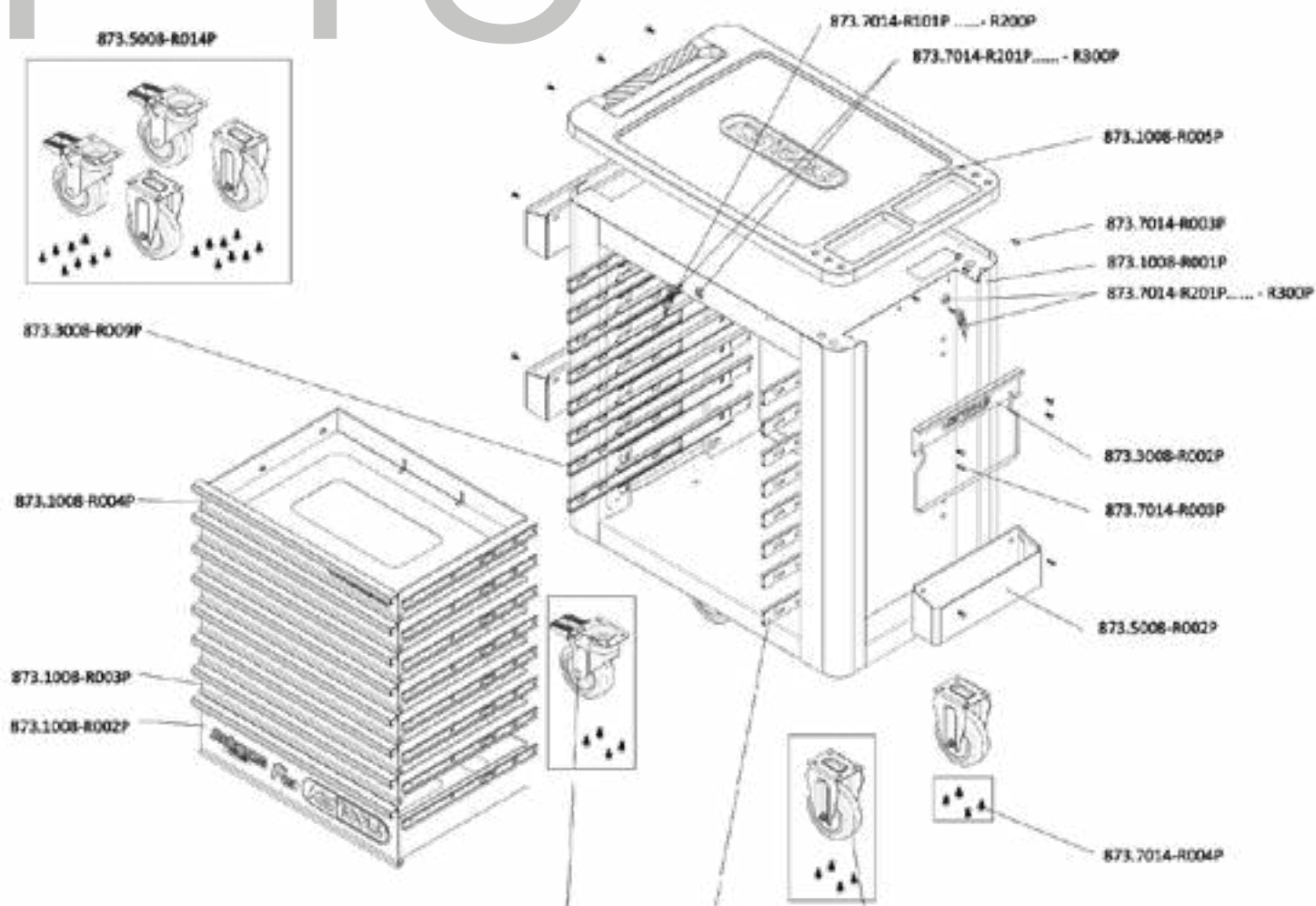

## INDIVIDUAL PARTS LIST

| Art.-Nr.          | Description  | amount |
|-------------------|--|--------|
| 873.7014-R101P... | Replacement key for PERFORMANCEplus workshop trolley lock number xyz                         | 2      |
| 873.7014-R201P... | Lock with 2 keys for PERFORMANCEplus workshop trolley lock number xyz                        | 2      |
| 873.1008-R001P    | Body of workshop trolley   | 1      |
| 873.1008-R002P    | Compartment with logo and ball-bearing guide, 568x398x145 mm                                 | 1      |
| 873.1008-R003P    | Compartment with ball-bearing guide, for workshop trolley P10/P10TC/P15, 568x398x65 mm       | 6      |
| 873.1008-R004P    | Compartment with website and ball-bearing guide, for workshop trolley P10/P15, 568x398x65 mm | 1      |
| 873.1008-R005P    | Plastic work surface with handle   | 1      |
| 873.3008-R002P    | Paper roll holder for PERFORMANCEplus workshop trolley P10/P15/P25                           | 1      |
| 873.3008-R008P    | Full extension (with ball-bearing guide) with automatic retraction                           | 8      |
| 873.3008-R009P    | Full extension (with ball-bearing guide) with automatic retraction                           | 8      |
| 873.5008-R002P    | Can holder for PERFORMANCEplus workshop trolley P10/P15/P25/P35                              | 3      |
| 873.5008-R009P    | Fixed castors for PERFORMANCEplus workshop trolley, incl. screws                             | 2      |
| 873.5008-R011P    | Swivel castors with brakes, for PERFORMANCEplus workshop trolley, incl. screws               | 2      |
| 873.5008-R014P    | Roller set for PERFORMANCEplus workshop trolley, incl. screws                                | 1      |
| 873.7014-R003P    | M6x12 screw (1 pcs.) for PERFORMANCEplus workshop trolley accessories                        | 16     |
| 873.7014-R004P    | M8 screws for PERFORMANCEplus workshop trolley rollers (16 pcs.)                             | 1      |



**873.7014-R101P...R200P**  
Replacement key for lock number xyz



**873.7014-R201P...R300P**  
Lock with 2 keys, lock number xyz



**873.3008-R008P**  
Full extension (with ball-bearing guide) with automatic retraction, right



**873.3008-R009P**  
Full extension (with ball-bearing guide) with automatic retraction, left



**873.5008-R009P**  
Fixed castors, incl. screws



**873.5008-R011P**  
Swivel castors with brakes, incl. screws



**873.5008-R014P**  
Roller set, incl. screws



**873.1008-R005P**  
Plastic work surface with handle



**873.1008-R004P**  
Compartment with website and ball-bearing guide, 568x398x65 mm



**873.1008-R003P**  
Compartment with ball-bearing guide, 568x398x65 mm



**873.1008-R002P**  
Compartment with logo and ball-bearing guide, 568x398x145 mm



**873.5008-R002P**  
Can holder including screws, W = 310 mm



**873.3008-R002P**  
Paper roll holder including screws, W= 320 mm



**873.7014-R004P**  
M8 screws (16 pcs.)



**873.7014-R003P**  
M6x12 screw (1 pcs.)



**873.1008-R001P**  
Body of workshop trolley



The only thing that can't be replaced is the quality!