

P15

workshop tool trolley
with 338 tools for 6 drawers
815.6338

THE COMPACT HEAVYWEIGHT

P15



Workshop trolley P15
with 8 compartments
873.1008



DUO Lock Brilliant locking system



Eight drawers each load capacity up to 50 kg



Stable **ball bearing**



Plastic Surface

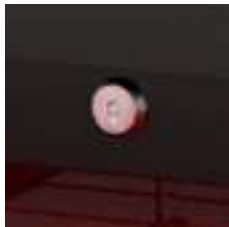

Lock lockable



Anti-static castors with brakes



Integrated **corner protection**



Paper roll holder included



Can holder included

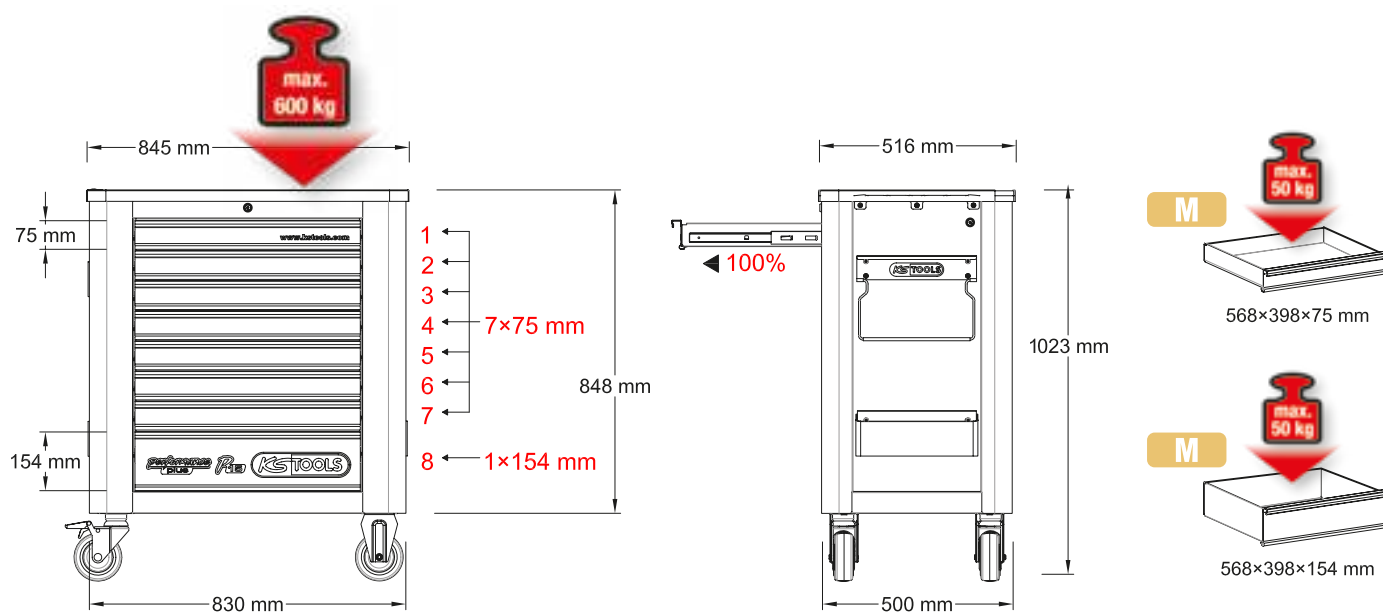

P15 workshop tool trolley set with 338 tools for 6 drawers

815.6338



Screwdriver set in foam insert

811.1027



1/4" + 3/8" socket spanner set in foam insert

811.1142



1/2" socket spanner set in foam insert

811.0066



Screw spanner set in foam insert

811.2041



Pliers and angle spanner set in foam insert

811.0045



Hammer and chisel set in foam insert

811.1017

811.1027

M Screwdriver set

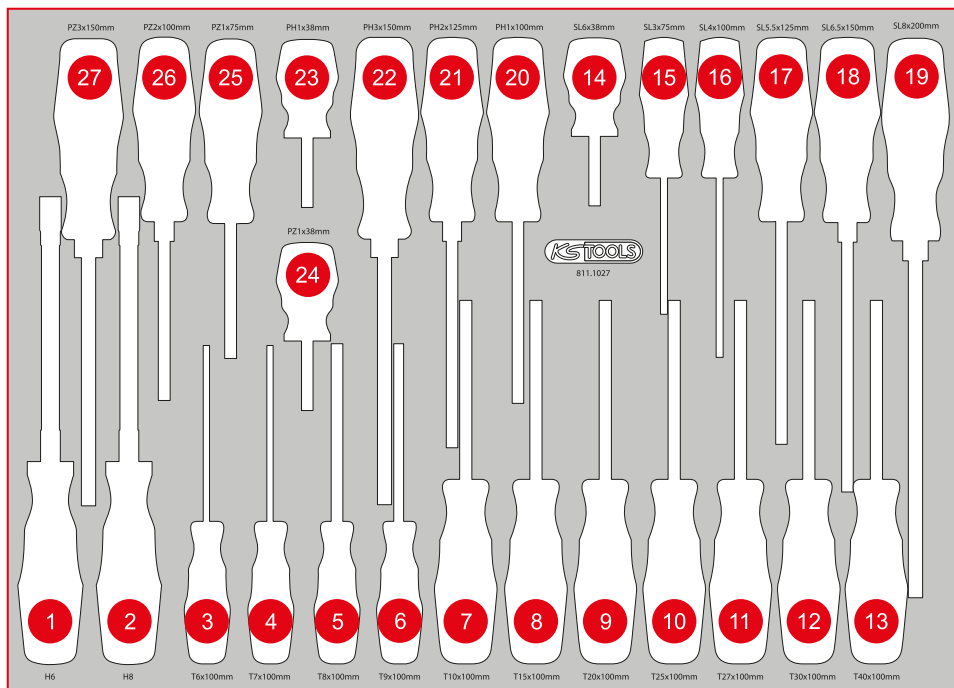
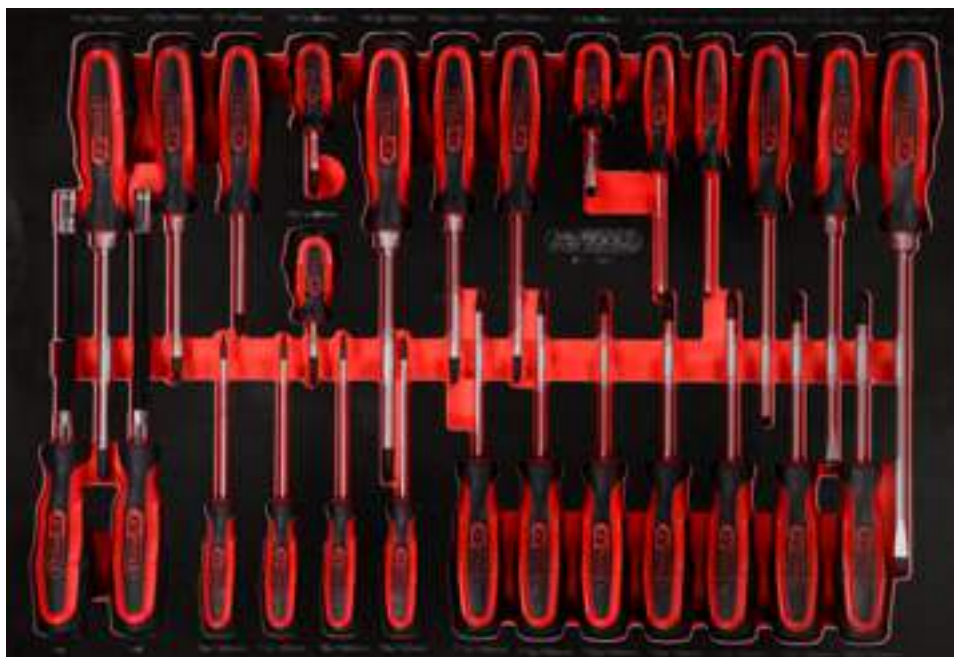

Pos.	Code	Description	pcs
1	159.1126	ERGOTORQUEplus Socket screwdriver, 6 mm	1
2	159.2128	ERGOTORQUEplus Socket screwdriver, 8 mm	1
3	159.1134	ERGOTORQUEplus screwdriver, Torx, T6	1
4	159.1135	ERGOTORQUEplus screwdriver, Torx, T7	1
5	159.1030	ERGOTORQUEplus screwdriver, Torx, T8	1
6	159.1031	ERGOTORQUEplus screwdriver, Torx, T9	1
7	159.1032	ERGOTORQUEplus screwdriver, Torx, T10	1
8	159.1033	ERGOTORQUEplus screwdriver, Torx, T15	1
9	159.1034	ERGOTORQUEplus screwdriver, Torx, T20	1
10	159.1035	ERGOTORQUEplus screwdriver, Torx, T25	1
11	159.1036	ERGOTORQUEplus screwdriver, Torx, T27	1
12	159.1037	ERGOTORQUEplus screwdriver, Torx, T30	1
13	159.1038	ERGOTORQUEplus screwdriver, Torx, T40	1
14	159.1001	ERGOTORQUEplus screwdriver for slotted screws, 6 mm, stubby	1
15	159.1002	ERGOTORQUEplus screwdriver for slotted screws, 4 mm, 180 mm	1
16	159.1004	ERGOTORQUEplus screwdriver for slotted screws, 5,5 mm, 230 mm	1
17	159.1006	ERGOTORQUEplus screwdriver for slotted screws, 6,5 mm, 255 mm	1
18	159.1009	ERGOTORQUEplus screwdriver for slotted screws, 8 mm, 315 mm	1
19	159.1011	ERGOTORQUEplus screwdriver for slotted screws, 8 mm, 315 mm	1
20	159.1029	ERGOTORQUEplus screwdriver, Torx, PH1, 205 mm	1
21	159.1022	ERGOTORQUEplus screwdriver, Torx, PH2, 230 mm	1
22	159.1024	ERGOTORQUEplus screwdriver, Torx, PH3, 265 mm	1
23	159.1141	ERGOTORQUEplus screwdriver for screws PH, PH1, stubby	1
24	159.1143	ERGOTORQUEplus screwdriver for screws PZ, PZ1, stubby	1
25	159.1040	ERGOTORQUEplus screwdriver for screws PZ, PZ1, 180 mm	1
26	159.1041	ERGOTORQUEplus screwdriver for screws PZ, PZ2, 205 mm	1
27	159.1044	ERGOTORQUEplus screwdriver for screws PZ, PZ3, 265 mm	1

M 1/4" + 3/8" socket spanner set

568 x 398



P10



P10TC



P15



P20



P30



P35



P45



Pos.	Code	Description	pcs	Pos.	Code	Description	pcs	Pos.	Code	Description	pcs
1	917.4807	3/8" Hexagonal socket, deep, 7 mm	1	25	911.3865	3/8" Bit socket hexagon, 5 mm	1	49	917.3808	3/8" Hexagonal socket, 8 mm	1
2	917.3828	3/8" Hexagonal socket, deep, 8 mm	1	26	911.38655	3/8" Bit socket hexagon, 5,5 mm	1	50	917.3809	3/8" Hexagonal socket, 9 mm	1
3	917.3829	3/8" Hexagonal socket, deep, 9 mm	1	27	911.3866	3/8" Bit socket hexagon, 6 mm	1	51	917.3810	3/8" Hexagonal socket, 10 mm	1
4	917.3830	3/8" Hexagonal socket, deep, 10 mm	1	28	911.3867	3/8" Bit socket hexagon, 7 mm	1	52	917.3811	3/8" Hexagonal socket, 11 mm	1
5	917.3831	3/8" Hexagonal socket, deep, 11 mm	1	29	911.3868	3/8" Bit socket hexagon, 8 mm	1	53	917.3812	3/8" Hexagonal socket, 12 mm	1
6	917.3832	3/8" Hexagonal socket, deep, 12 mm	1	30	917.3969	3/8" Bit socket hexagon, 9 mm	1	54	917.3813	3/8" Hexagonal socket, 13 mm	1
7	917.3833	3/8" Hexagonal socket, deep, 13 mm	1	31	917.3857	3/8" Bit socket hexagon, 10 mm	1	55	917.3814	3/8" Hexagonal socket, 14 mm	1
8	917.3834	3/8" Hexagonal socket, deep, 14 mm	1	32	911.3918	3/8" Bit socket spline (XZN), M4	1	56	917.3815	3/8" Hexagonal socket, 15 mm	1
9	917.3835	3/8" Hexagonal socket, deep, 15 mm	1	33	911.3915	3/8" Bit socket spline (XZN), M5	1	57	917.3816	3/8" Hexagonal socket, 16 mm	1
10	917.3836	3/8" Hexagonal socket, deep, 16 mm	1	34	911.3916	3/8" Bit socket spline (XZN), M6	1	58	917.3817	3/8" Hexagonal socket, 17 mm	1
11	917.3837	3/8" Hexagonal socket, deep, 17 mm	1	35	911.3917	3/8" Bit socket spline (XZN), M8	1	59	917.3818	3/8" Hexagonal socket, 18 mm	1
12	917.3838	3/8" Hexagonal socket, deep, 18 mm	1	36	917.3901	3/8" Bit socket spline (XZN), M9	1	60	917.3819	3/8" Hexagonal socket, 19 mm	1
13	917.3839	3/8" Hexagonal socket, deep, 19 mm	1	37	911.3920	3/8" Bit socket spline (XZN), M10	1	61	917.3820	3/8" Hexagonal socket, 20 mm	1
14	917.3840	3/8" Hexagonal socket, deep, 20 mm	1	38	917.3903	3/8" Bit socket spline (XZN), M12	1	62	917.3821	3/8" Hexagonal socket, 21 mm	1
15	917.3841	3/8" Hexagonal socket, deep, 21 mm	1	39	911.3869	3/8" Bit socket Torx, T15	1	63	917.3822	3/8" Hexagonal socket, 22 mm	1
16	917.4851	3/8" 12-edge socket with joint, 10 mm	1	40	911.3870	3/8" Bit socket Torx, T20	1	64	911.4339	3/8" Torx E Socket, E5	1
17	917.4852	3/8" 12-edge socket with joint, 11 mm	1	41	911.3871	3/8" Bit socket Torx, T25	1	65	911.4340	3/8" Torx E Socket, E6	1
18	917.4853	3/8" 12-edge socket with joint, 12 mm	1	42	911.3872	3/8" Bit socket Torx, T27	1	66	911.4341	3/8" Torx E Socket, E7	1
19	917.4854	3/8" 12-edge socket with joint, 13 mm	1	43	911.3873	3/8" Bit socket Torx, T30	1	67	911.4342	3/8" Torx E Socket, E8	1
20	917.4855	3/8" 12-edge socket with joint, 14 mm	1	44	911.3874	3/8" Bit socket Torx, T40	1	68	911.4318	3/8" Torx E Socket, E10	1
21	917.4856	3/8" 12-edge socket with joint, 15 mm	1	45	911.3885	3/8" Bit socket Torx, T45	1	69	911.4319	3/8" Torx E Socket, E11	1
22	917.4857	3/8" 12-edge socket with joint, 16 mm	1	46	911.3884	3/8" Bit socket Torx, T50	1	70	911.4320	3/8" Torx E Socket, E12	1
23	911.3863	3/8" Bit socket hexagon, 3 mm	1	47	911.3888	3/8" Bit socket Torx, T55	1	71	911.4321	3/8" Torx E Socket, E14	1
24	911.3864	3/8" Bit socket hexagon, 4 mm	1	48	917.3807	3/8" Hexagonal socket, 7 mm	1	72	917.1448	1/4" Hexagonal socket, deep, 14 mm	1

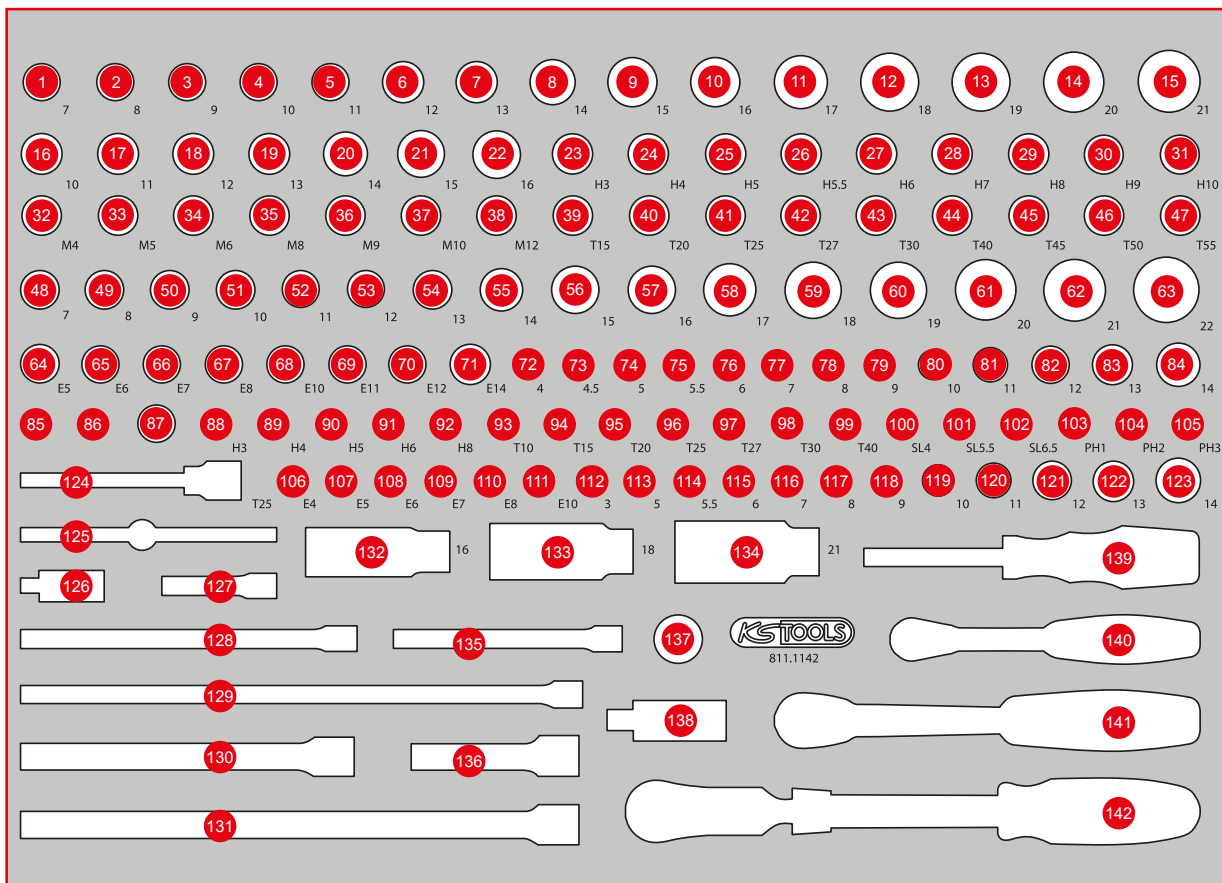

Pos.	Code	Description	pcs	Pos.	Code	Description	pcs	Pos.	Code	Description	pcs
73	917.1525	1/4" Hexagonal socket, deep, 4 mm	1	97	911.1449	1/4" Bit socket Torx, T27	1	121	917.1412	1/4" Hexagonal socket, 12 mm	1
74	917.1526	1/4" Hexagonal socket, deep, 4,5 mm	1	98	911.1446	1/4" Bit socket Torx, T30	1	122	917.1413	1/4" Hexagonal socket, 13 mm	1
75	917.1527	1/4" Hexagonal socket, deep, 5 mm	1	99	911.1447	1/4" Bit socket Torx, T40	1	123	917.1414	1/4" Hexagonal socket, 14 mm	1
76	917.1528	1/4" Hexagonal socket, deep, 5,5 mm	1	100	911.1418	1/4" Bit socket slot, 4 mm	1	124	911.1552	3/8" Bit socket Torx, long, T25	1
77	917.1426	1/4" Hexagonal socket, deep, 6 mm	1	101	911.1419	1/4" Bit socket slot, 5,5 mm	1	125	911.1425	Sliding T-bar, 1/4", 110 mm	1
78	917.1427	1/4" Hexagonal socket, deep, 7 mm	1	102	917.1421	1/4" Bit socket slot, 6,5 mm	1	126	911.1450	1/4" Universal joint	1
79	917.1428	1/4" Hexagonal socket, deep, 8 mm	1	103	911.1415	1/4" Bit socket, PH1	1	127	911.1423	1/4" Extension with hexagon drive, 50 mm	1
80	917.1429	1/4" Hexagonal socket, deep, 9 mm	1	104	911.1416	1/4" Bit socket, PH2	1	128	911.1451	1/4" Extension with hexagon drive, 150 mm	1
81	917.1430	1/4" Hexagonal socket, deep, 10 mm	1	105	911.1417	1/4" Bit socket, PH3	1	129	911.1504	1/4" Extension with hexagon drive, 250 mm	1
82	917.1431	1/4" Hexagonal socket, deep, 11 mm	1	106	911.4313	1/4" Torx E Socket, E4	1	130	911.3802	3/8" Extension with knurling, 150 mm	1
83	917.1432	1/4" Hexagonal socket, deep, 12 mm	1	107	911.4314	1/4" Torx E Socket, E5	1	131	911.3803	3/8" Extension with knurling, 250 mm	1
84	917.1433	1/4" Hexagonal socket, deep, 13 mm	1	108	911.4315	1/4" Torx E Socket, E6	1	132	911.3804	3/8" Spark plug socket, 16 mm	1
85	911.0101	1/4" socket with magnet	1	109	911.4316	1/4" Torx E Socket, E7	1	133	911.3823	3/8" Spark plug socket, 18 mm	1
86	911.1494	1/4" Adaptor, 1/4"F x 3/8"M	1	110	911.4317	1/4" Torx E Socket, E8	1	134	911.3805	3/8" Spark plug socket, 21 mm	1
87	911.3897	3/8" Reducing adaptor, 3/8"F x 1/4"M	1	111	911.4332	1/4" Torx E Socket, E10	1	135	911.1424	1/4" Extension with hexagon drive, 100 mm	1
88	911.1436	1/4" Bit socket hexagon, 3 mm	1	112	917.1445	1/4" Hexagonal socket, 3 mm	1	136	911.3801	3/8" Extension with knurling, 75 mm	1
89	911.1437	1/4" Bit socket hexagon, 4 mm	1	113	917.1405	1/4" Hexagonal socket, 5 mm	1	137	911.1233	1/2" Reducing adaptor, 1/2"F x 3/8"M	1
90	911.1438	1/4" Bit socket hexagon, 5 mm	1	114	917.14055	1/4" Hexagonal socket, 5,5 mm	1	138	911.3850	3/8" Universal joint	1
91	911.1439	1/4" Bit socket hexagon, 6 mm	1	115	917.1406	1/4" Hexagonal socket, 6 mm	1	139	911.1434	1/4" Square drive screwdriver, 150 mm	1
92	911.1441	1/4" Bit socket hexagon, 8 mm	1	116	917.1407	1/4" Hexagonal socket, 7 mm	1	140	920.1490	1/4" SlimPOWER Reversible ratchet, 72 teeth	1
93	911.1442	1/4" Bit socket Torx, T10	1	117	917.1408	1/4" Hexagonal socket, 8 mm	1	141	920.3890	3/8" SlimPOWER Reversible ratchet, 72 teeth	1
94	911.1443	1/4" Bit socket Torx, T15	1	118	917.1409	1/4" Hexagonal socket, 9 mm	1	142	914.3820	3/8" SlimPOWER Telescopic reversible ratchet, 72 teeth	1
95	911.1444	1/4" Bit socket Torx, T20	1	119	917.1410	1/4" Hexagonal socket, 10 mm	1				
96	911.1445	1/4" Bit socket Torx, T25	1	120	917.1411	1/4" Hexagonal socket, 11 mm	1				

811.0066

M 1/2" Socket spanner set

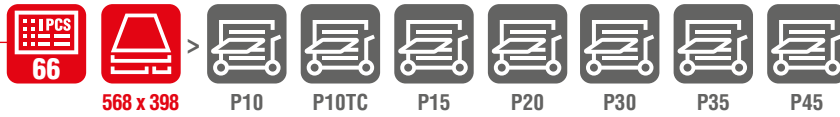

Pos.	Code	Description	pcs	Pos.	Code	Description	pcs	Pos.	Code	Description	pcs
1	911.1306	1/2" Bit socket hexagon, short, 6 mm	1	12	911.1363	1/2" Bit socket Torx, T27	1	23	911.4333	1/2" Torx E Socket, E10	1
2	911.1307	1/2" Bit socket hexagon, short, 7 mm	1	13	911.1364	1/2" Bit socket Torx, T30	1	24	911.4334	1/2" Torx E Socket, E11	1
3	911.1308	1/2" Bit socket hexagon, short, 8 mm	1	14	911.1365	1/2" Bit socket Torx, T40	1	25	911.4335	1/2" Torx E Socket, E12	1
4	911.1309	1/2" Bit socket hexagon, short, 9 mm	1	15	911.1366	1/2" Bit socket Torx, T45	1	26	911.4336	1/2" Torx E Socket, E14	1
5	911.1310	1/2" Bit socket hexagon, short, 10 mm	1	16	911.1367	1/2" Bit socket Torx, T50	1	27	911.4322	1/2" Torx E Socket, E16	1
6	911.1312	1/2" Bit socket hexagon, short, 12 mm	1	17	911.1368	1/2" Bit socket Torx, T55	1	28	911.4323	1/2" Torx E Socket, E18	1
7	911.1314	1/2" Bit socket hexagon, short, 14 mm	1	18	911.1369	1/2" Bit socket Torx, T60	1	29	911.4324	1/2" Torx E Socket, E20	1
8	911.1317	1/2" Bit socket hexagon, short, 17 mm	1	19	911.1374	1/2" Bit socket Torx tamperproof, TB30	1	30	911.4325	1/2" Torx E Socket, E22	1
9	911.1319	1/2" Bit socket hexagon, short, 19 mm	1	20	911.1375	1/2" Bit socket Torx tamperproof, TB40	1	31	911.4326	1/2" Torx E Socket, E24	1
10	911.1361	1/2" Bit socket Torx, T20	1	21	911.1376	1/2" Bit socket Torx tamperproof, TB45	1	32	911.3892	Adaptor, 3/8" Fx1/2" M	1
11	911.1362	1/2" Bit socket Torx, T25	1	22	911.1377	1/2" Bit socket Torx tamperproof, TB50	1	33	911.1233	Reducing adaptor, 1/2" F x 3/8" M	1

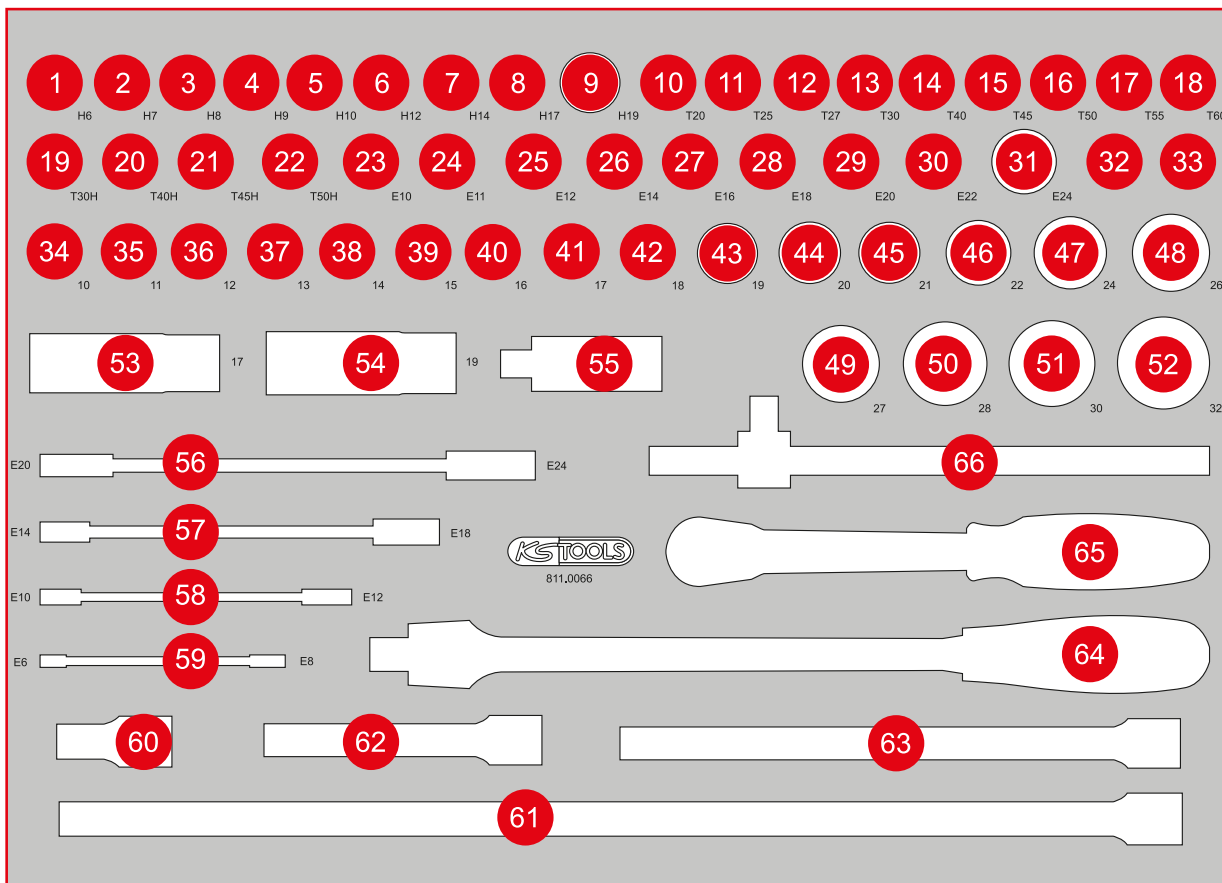

Pos.	Code	Description	pcs	Pos.	Code	Description	pcs	Pos.	Code	Description	pcs
34	917.1210	1/2" Hexagonal socket, 10 mm	1	45	917.1221	1/2" Hexagonal socket, 21 mm	1	56	911.0376	Double ring spanner for Torx E profile, E20 x E24	1
35	917.1211	1/2" Hexagonal socket, 11 mm	1	46	917.1222	1/2" Hexagonal socket, 22 mm	1	57	911.0374	Double ring spanner for Torx E profile, E14 x E18	1
36	917.1212	1/2" Hexagonal socket, 12 mm	1	47	917.1224	1/2" Hexagonal socket, 24 mm	1	58	911.0373	Double ring spanner for Torx E profile, E10 x E12	1
37	917.1213	1/2" Hexagonal socket, 13 mm	1	48	917.1343	1/2" Hexagonal socket, 26 mm	1	59	911.0371	Double ring spanner for Torx E profile, E6 x E8	1
38	917.1214	1/2" Hexagonal socket, 14 mm	1	49	917.1227	1/2" Hexagonal socket, 27 mm	1	60	911.1381	Wobble extension, 1/2", 50 mm	1
39	917.1215	1/2" Hexagonal socket, 15 mm	1	50	917.1344	1/2" Hexagonal socket, 28 mm	1	61	911.1836	Wobble extension, 1/2", 500 mm	1
40	917.1216	1/2" Hexagonal socket, 16 mm	1	51	917.1230	1/2" Hexagonal socket, 30 mm	1	62	911.1202	1/2" Extensions, 125 mm	1
41	917.1217	1/2" Hexagonal socket, 17 mm	1	52	917.1232	1/2" Hexagonal socket, 32 mm	1	63	911.1203	1/2" Extensions, 250 mm	1
42	917.1218	1/2" Hexagonal socket, 18 mm	1	53	515.0992	SlimPOWER 1/2" Alloy rim impact socket, 17 mm	1	64	917.1455	1/2" Flexi head drive handle	1
43	917.1219	1/2" Hexagonal socket, 19 mm	1	54	515.0993	SlimPOWER 1/2" Alloy rim impact socket, 19 mm	1	65	920.1290	1/2" SlimPOWER Reversible ratchet, 72 teeth	1
44	917.1220	1/2" Hexagonal socket, 20 mm	1	55	911.1250	1/2" Universal joint	1	66	911.1204	Sliding T-bar, 1/2", 250 mm	1

811.2041

M Screw spanner set



568 x 398

P10

P10TC

P15

P20

P30

P35

P45

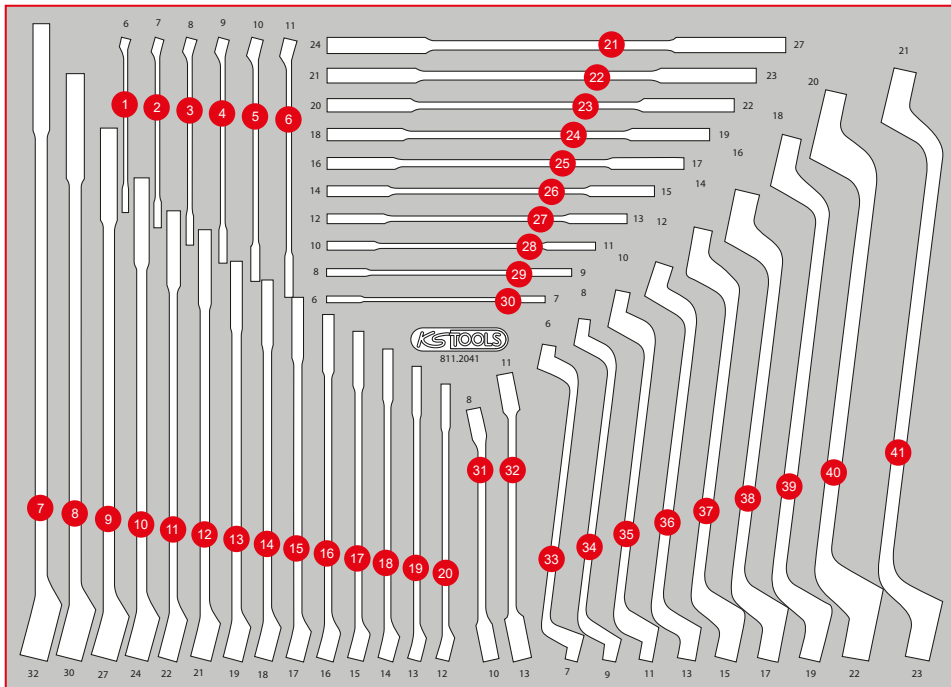

Pos.	Code	Description	pcs
1	517.0606	Combination spanners, offset, 6 mm	1
2	517.0607	Combination spanners, offset, 7 mm	1
3	517.0608	Combination spanners, offset, 8 mm	1
4	517.0609	Combination spanners, offset, 9 mm	1
5	517.0610	Combination spanners, offset, 10 mm	1
6	517.0611	Combination spanners, offset, 11 mm	1
7	517.0632	Combination spanners, offset, 32 mm	1
8	517.0630	Combination spanners, offset, 30 mm	1
9	517.0627	Combination spanners, offset, 27 mm	1
10	517.0624	Combination spanners, offset, 24 mm	1
11	517.0622	Combination spanners, offset, 22 mm	1
12	517.0621	Combination spanners, offset, 21 mm	1
13	517.0619	Combination spanners, offset, 19 mm	1
14	517.0618	Combination spanners, offset, 18 mm	1
15	517.0617	Combination spanners, offset, 17 mm	1
16	517.0616	Combination spanners, offset, 16 mm	1
17	517.0615	Combination spanners, offset, 15 mm	1
18	517.0614	Combination spanners, offset, 14 mm	1
19	517.0613	Combination spanners, offset, 13 mm	1
20	517.0612	Combination spanners, offset, 12 mm	1
21	517.0716	Double open ended spanners, 24 x 27 mm	1
22	517.0715	Double open ended spanners, 21 x 23 mm	1
23	517.0714	Double open ended spanners, 20 x 22 mm	1
24	517.0712	Double open ended spanners, 18 x 19 mm	1
25	517.0710	Double open ended spanners, 16 x 17 mm	1
26	517.0709	Double open ended spanners, 14 x 15 mm	1
27	517.0707	Double open ended spanners, 12 x 13 mm	1
28	517.0704	Double open ended spanners, 10 x 11 mm	1
29	517.0702	Double open ended spanners, 8 x 9 mm	1
30	517.0701	Double open ended spanners, 6 x 7 mm	1
31	517.0252	Open double ring spanner, offset, 8 x 10 mm	1
32	517.9244	Open double ring spanner, offset, 11 x 13 mm	1
33	517.0801	Double ring spanner, offset, 6 x 7 mm	1
34	517.0802	Double ring spanner, offset, 8 x 9 mm	1
35	517.0804	Double ring spanner, offset, 10 x 11 mm	1
36	517.0807	Double ring spanner, offset, 12 x 13 mm	1
37	517.0809	Double ring spanner, offset, 14 x 15 mm	1
38	517.0810	Double ring spanner, offset, 16 x 17 mm	1
39	517.0812	Double ring spanner, offset, 18 x 19 mm	1
40	517.0813	Double ring spanner, offset, 20 x 22 mm	1
41	517.0815	Double ring spanner, offset, 21 x 23 mm	1

811.0045

M Pliers and angle spanner set



Pos.	Code	Description	pcs
1	151.5210	Ball head Torx angled socket wrench set, extra long, 9 pcs	9
2	151.4420	Ball ended hexagon key wrench set, extra long, 9 pcs	9
3	115.1012	ERGOTORQUE diagonal side cutter, 160 mm	1
4	115.1021	ERGOTORQUE combination pliers, 180 mm	1
5	115.1024	ERGOTORQUE long nose pliers serrated cutter, 200 mm	1
6	907.2166	Snap off blades 0,5 x 18 x 100 mm, dispenser with 10 pieces	10
7	907.2135	Universal snap off blade knife 18 mm	1
8	115.1033	Self grip wrench, 220 mm	1
9	115.2010	Water pump pliers, 240 mm	1
10	500.1035	Circlip pliers for internal circlips, 160 mm	1
11	500.1032	Circlip pliers for internal circlips, angled, 160 mm	1
12	500.1029	Circlip pliers for external circlips, 160 mm	1
13	500.1026	Circlip pliers for external circlips, angled, 160 mm	1
14	151.2341	Torx key wrench, short, T6	1
15	151.2342	Torx key wrench, short, T7	1
16	151.2343	Torx key wrench, short, T8	1
17	151.2344	Torx key wrench, short, T9	1
18	550.1001	2in1 Telescopic solenoid holder with washer jet cleaning and setting tool, 150-675 mm	1
19	150.4370	perfectLight torch 85 lumen	1
20	550.1025	Flexible magnet lifter, 510 mm, Øhead=15 mm	1

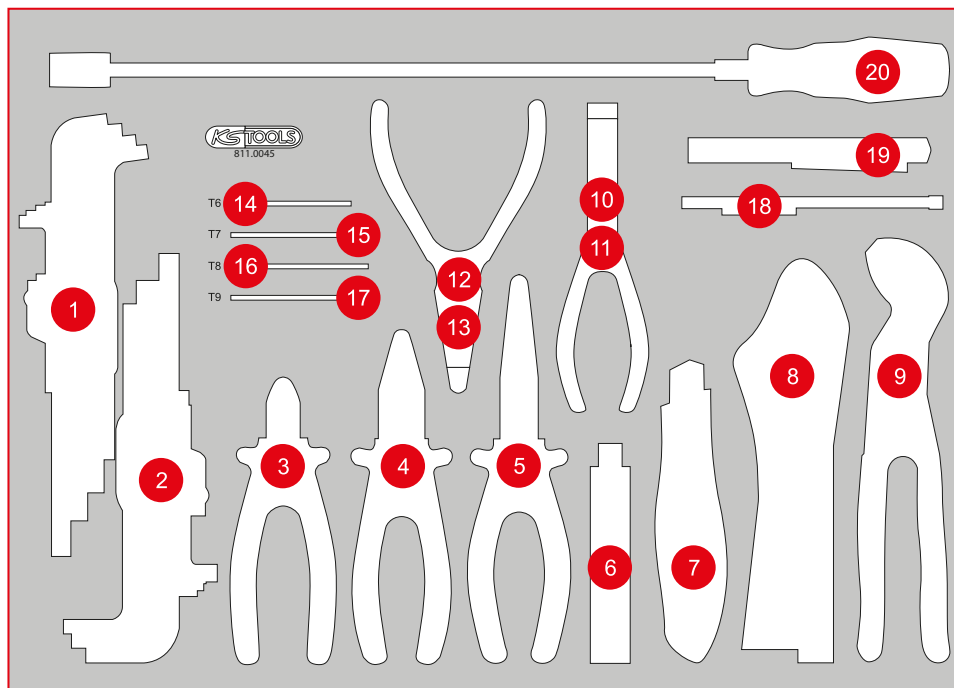

811.1017

M Hammer and chisel set



Pos.	Code	Description	pcs
1	150.1670	Test probe 6-24V DC with 5 m cable	1
2	911.8146	Tyre lever, 370 mm	1
3	156.0243	Centre punch, octagon 10 mm	1
4	156.0242	Cross chisel, octagon, 7 mm	1
5	156.0254	Flat chisel, octagon, 20 mm	1
6	156.0241	Flat chisel, octagon, 18 mm	1
7	156.0235	Pin punch, Ø 8 mm, cylindrical shaft	1
8	156.0234	Pin punch, Ø 6 mm, cylindrical shaft	1
9	156.0233	Pin punch, Ø 5 mm, cylindrical shaft	1
10	156.0232	Pin punch, Ø 4 mm, cylindrical shaft	1
11	156.0231	Pin punch, Ø 3 mm, cylindrical shaft	1
12	907.2222	Gasket scraper, 25 x 200 mm	1
13	201.2335	Steel wire brake saddle brush, 2-row, straight 225 mm	1
14	300.0114	Tape measure with locking device and belt clip, black red, 5 m, 19 mm	1
15	142.1402	Fitters Hammer, fiberglas handle, 400 g	1
16	140.5252	Recoil free soft faced Hammer, 400 g	1
17	911.8138	Trim plastic wedge, 195 x30 mm	1

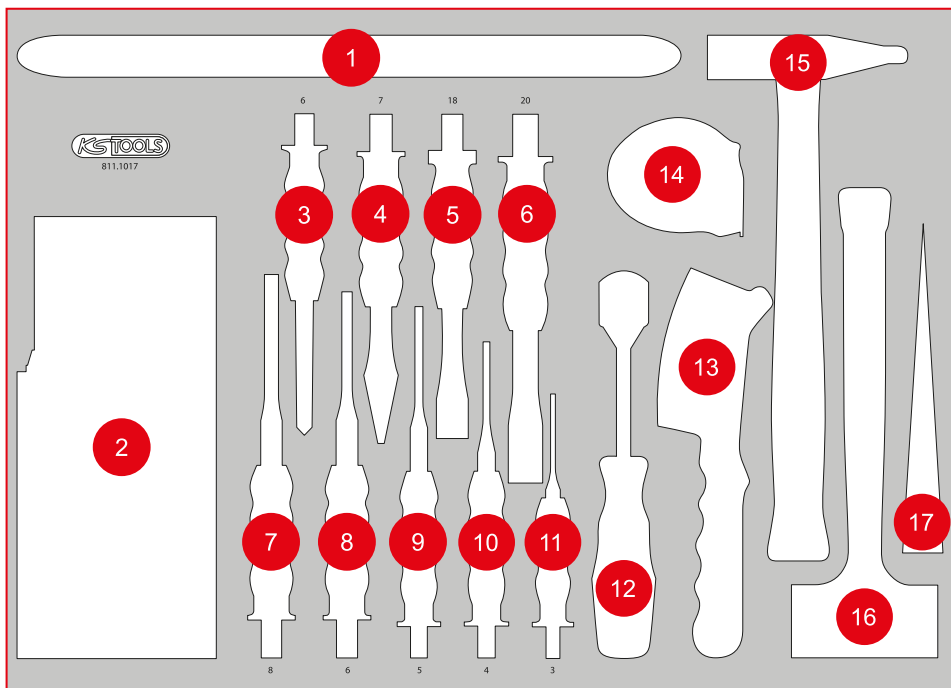

P15

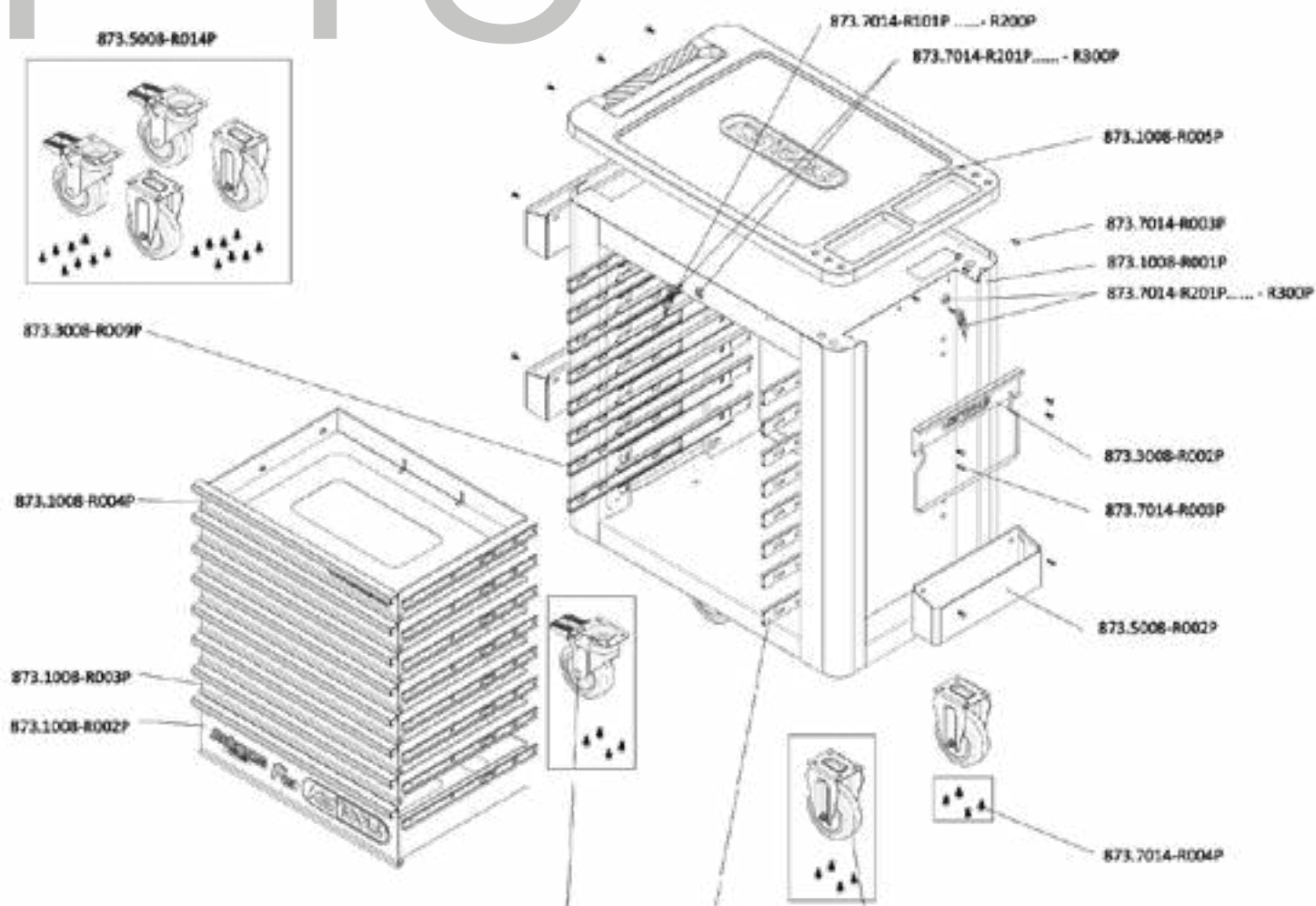

INDIVIDUAL PARTS LIST

Art.-Nr.	Description	amount
873.7014-R101P...	Replacement key for PERFORMANCEplus workshop trolley lock number xyz	2
873.7014-R201P...	Lock with 2 keys for PERFORMANCEplus workshop trolley lock number xyz	2
873.1008-R001P	Body of workshop trolley	1
873.1008-R002P	Compartment with logo and ball-bearing guide, 568x398x145 mm	1
873.1008-R003P	Compartment with ball-bearing guide, for workshop trolley P10/P10TC/P15, 568x398x65 mm	6
873.1008-R004P	Compartment with website and ball-bearing guide, for workshop trolley P10/P15, 568x398x65 mm	1
873.1008-R005P	Plastic work surface with handle	1
873.3008-R002P	Paper roll holder for PERFORMANCEplus workshop trolley P10/P15/P25	1
873.3008-R008P	Full extension (with ball-bearing guide) with automatic retraction	8
873.3008-R009P	Full extension (with ball-bearing guide) with automatic retraction	8
873.5008-R002P	Can holder for PERFORMANCEplus workshop trolley P10/P15/P25/P35	3
873.5008-R009P	Fixed castors for PERFORMANCEplus workshop trolley, incl. screws	2
873.5008-R011P	Swivel castors with brakes, for PERFORMANCEplus workshop trolley, incl. screws	2
873.5008-R014P	Roller set for PERFORMANCEplus workshop trolley, incl. screws	1
873.7014-R003P	M6x12 screw (1 pcs.) for PERFORMANCEplus workshop trolley accessories	16
873.7014-R004P	M8 screws for PERFORMANCEplus workshop trolley rollers (16 pcs.)	1



873.7014-R101P...R200P
Replacement key for lock number xyz



873.7014-R201P...R300P
Lock with 2 keys, lock number xyz



873.3008-R008P
Full extension (with ball-bearing guide) with automatic retraction, right



873.3008-R009P
Full extension (with ball-bearing guide) with automatic retraction, left



873.5008-R009P
Fixed castors, incl. screws



873.5008-R011P
Swivel castors with brakes, incl. screws



873.5008-R014P
Roller set, incl. screws



873.1008-R005P
Plastic work surface with handle



873.1008-R004P
Compartment with website and ball-bearing guide, 568x398x65 mm



873.1008-R003P
Compartment with ball-bearing guide, 568x398x65 mm



873.1008-R002P
Compartment with logo and ball-bearing guide, 568x398x145 mm



873.5008-R002P
Can holder including screws, W = 310 mm



873.3008-R002P
Paper roll holder including screws, W= 320 mm



873.7014-R004P
M8 screws (16 pcs.)



873.7014-R003P
M6x12 screw (1 pcs.)



873.1008-R001P
Body of workshop trolley



The only thing that can't be replaced is the quality!