

P15

workshop tool trolley
with 403 tools for 7 drawers
815.7403

THE COMPACT HEAVYWEIGHT

P15



Workshop trolley P15
with 8 compartments
873.1008



DUO Lock Brilliant locking system



Eight drawers each load capacity up to 50 kg



Stable **ball bearing**



Plastic Surface

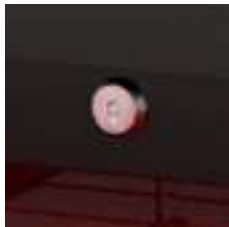

Lock lockable



Anti-static castors with brakes



Integrated **corner protection**



Paper roll holder included



Can holder included

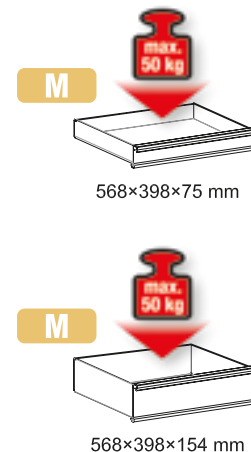
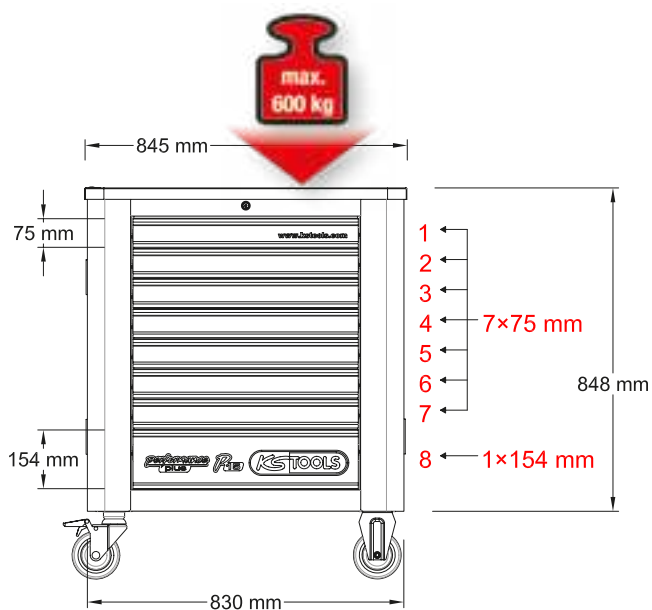

P15 workshop tool trolley set with 403 tools for 7 drawers

815.7403



IPCS
403

M

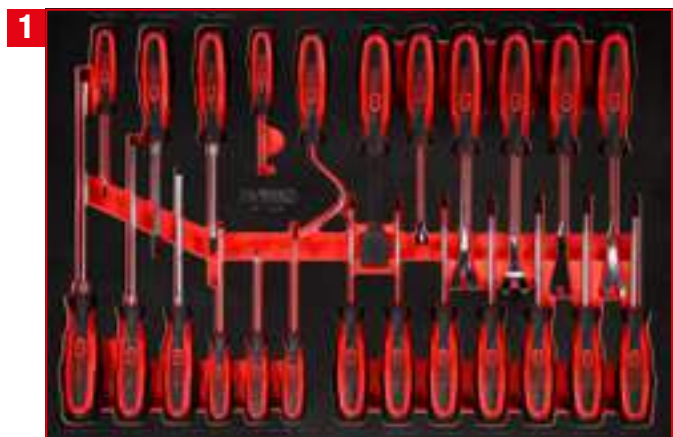

Screwdriver set in foam insert

811.3024

IPCS
24

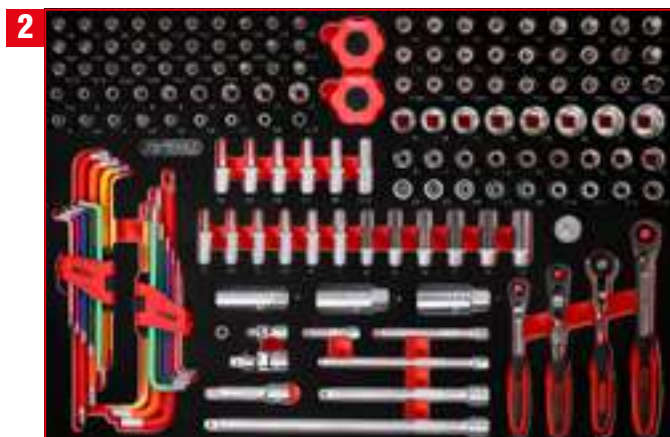

1/4" + 3/8" socket spanner set in foam insert

811.0156

IPCS
156

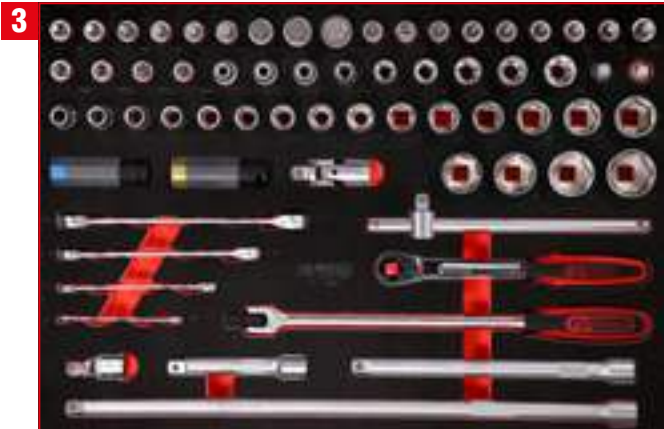

1/2" socket spanner set in foam insert

811.0066



1/2" socket spanner and screwdriver bit set

811.0063



Screw spanner set in foam insert

811.2041



Screwdriver and spanner set in foam insert

811.1032



Hammer, chisel and file set in foam insert

811.0021



811.3024

M Screwdriver set

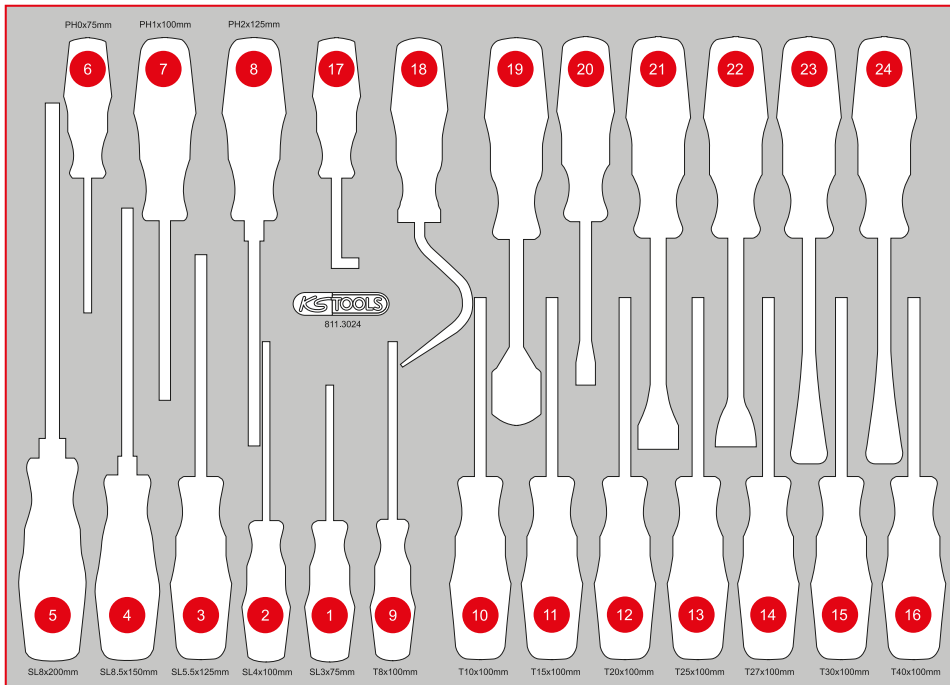

Pos.	Code	Description	pcs
1	159.1002	ERGOTORQUEplus screwdriver for slotted screws, 3 mm, 155 mm	1
2	159.1004	ERGOTORQUEplus screwdriver for slotted screws, 4 mm, 180 mm	1
3	159.1006	ERGOTORQUEplus screwdriver for slotted screws, 5,5 mm, 230 mm	1
4	159.1011	ERGOTORQUEplus screwdriver for slotted screws, 8 mm, 315 mm	1
5	159.1009	ERGOTORQUEplus screwdriver for slotted screws, 6,5 mm, 255 mm	1
6	159.1027	ERGOTORQUEplus screwdriver for screws PH, PH0, 155 mm	1
7	159.1029	ERGOTORQUEplus screwdriver for screws PH, PH1, 205 mm	1
8	159.1022	ERGOTORQUEplus screwdriver for screws PH, PH2, 230 mm	1
9	159.1030	ERGOTORQUEplus screwdriver, Torx, T8	1
10	159.1032	ERGOTORQUEplus screwdriver, Torx, T10	1
11	159.1033	ERGOTORQUEplus screwdriver, Torx, T15	1
12	159.1034	ERGOTORQUEplus screwdriver, Torx, T20	1
13	159.1035	ERGOTORQUEplus screwdriver, Torx, T25	1
14	159.1036	ERGOTORQUEplus screwdriver, Torx, T27	1
15	159.1037	ERGOTORQUEplus screwdriver, Torx, T30	1
16	159.1038	ERGOTORQUEplus screwdriver, Torx, T40	1
17	550.1048	Hook, 90° offset	1
18	550.1073	Hook, large, sickle	1
19	907.2222	Gasket scraper, 25 x 200 mm	1
20	140.2371	Clip remover short, length 245 mm, opening 4 mm	1
21	140.2616	Clip remover short, length 240 mm, opening 7,5 mm	1
22	140.2615	Clip remover short, length 240 mm, opening 9 mm	1
23	140.2617	Clip remover short, length 240 mm, opening 5 mm	1
24	140.2373	Clip remover short, length 245 mm, opening 10 mm	1

M 1/4" + 3/8" socket spanner set

Pos.	Code	Description	pcs	Pos.	Code	Description	pcs	Pos.	Code	Description	pcs
1	920.3890	3/8" SlimPOWER Reversible ratchet, 72 teeth	1	22	917.1527	1/4" Hexagonal socket, deep, 5 mm	1	46	917.1410	1/4" Hexagonal socket, 10 mm	1
2	914.1405	1/4" MODIFIX mini T-handle swivel head ratchet, 72 teeth	1	23	917.1528	1/4" Hexagonal socket, deep, 5,5 mm	1	47	917.1411	1/4" Hexagonal socket, 11 mm	1
3	914.1420	1/4" SlimPOWER telescopic-joint reversible ratchet, 72 teeth	1	24	917.1426	1/4" Hexagonal socket, deep, 6 mm	1	48	917.1412	1/4" Hexagonal socket, 12 mm	1
4	920.1490	1/4" SlimPOWER Reversible ratchet, 72 teeth	1	25	917.1427	1/4" Hexagonal socket, deep, 7 mm	1	49	917.1413	1/4" Hexagonal socket, 13 mm	1
5	911.1423	1/4" Extension with hexagon drive, 50 mm	1	26	917.1428	1/4" Hexagonal socket, deep, 8 mm	1	50	911.4313	1/4" Torx E Socket, E4	1
6	911.1424	1/4" Extension with hexagon drive, 100 mm	1	27	917.1429	1/4" Hexagonal socket, deep, 9 mm	1	51	911.4314	1/4" Torx E Socket, E5	1
7	911.1451	1/4" Extension with hexagon drive, 150 mm	1	28	917.1430	1/4" Hexagonal socket, deep, 10 mm	1	52	911.4315	1/4" Torx E Socket, E6	1
8	911.3801	3/8" Extension with knurling, 75 mm	1	29	917.1431	1/4" Hexagonal socket, deep, 11 mm	1	53	911.4316	1/4" Torx E Socket, E7	1
9	911.3802	3/8" Extension with knurling, 150 mm	1	30	917.1432	1/4" Hexagonal socket, deep, 12 mm	1	54	911.4317	1/4" Torx E Socket, E8	1
10	911.3803	3/8" Extension with knurling, 250 mm	1	31	917.1433	1/4" Hexagonal socket, deep, 13 mm	1	55	911.4332	1/4" Torx E Socket, E10	1
11	911.1450	1/4" Universal joint	1	32	917.2401	1/4" Torx E Socket, deep, E4	1	56	911.4407	1/4" Bit socket Torx, T6	1
12	911.3850	3/8" Universal joint	1	33	917.2402	1/4" Torx E Socket, deep, E5	1	57	911.4362	1/4" Bit socket Torx, T7	1
13	911.0101	1/4" socket with magnet	1	34	917.2403	1/4" Torx E Socket, deep, E6	1	58	911.1448	1/4" Bit socket Torx, T8	1
14	911.3804	3/8" Spark plug socket, 16 mm	1	35	917.2404	1/4" Torx E Socket, deep, E7	1	59	911.1478	1/4" Bit socket Torx, T9	1
15	911.3823	3/8" Spark plug socket, 18 mm	1	36	917.2405	1/4" Torx E Socket, deep, E8	1	60	911.1442	1/4" Bit socket Torx, T10	1
16	911.3805	3/8" Spark plug socket, 21 mm	1	37	917.2406	1/4" Torx E Socket, deep, E10	1	61	911.1443	1/4" Bit socket Torx, T15	1
17	911.3826	3/8" Sliding / reducing adaptor, 1/2" F x 3/8" M	1	38	917.1404	1/4" Hexagonal socket, 4 mm	1	62	911.1444	1/4" Bit socket Torx, T20	1
18	151.4530	Ball ended Torx key wrench set, extra long and bent 108°, 9 pcs	9	39	917.14045	1/4" Hexagonal socket, 4,5 mm	1	63	911.1445	1/4" Bit socket Torx, T25	1
19	151.4420	Ball ended hexagon key wrench set, extra long, 9 pcs	9	40	917.1405	1/4" Hexagonal socket, 5 mm	1	64	917.1456	1/4" Bit socket Torx tamperproof, TB6	1
20	917.1525	1/4" Hexagonal socket, deep, 4 mm	1	41	917.14055	1/4" Hexagonal socket, 5,5 mm	1	65	917.1457	1/4" Bit socket Torx tamperproof, TB7	1
21	917.1526	1/4" Hexagonal socket, deep, 4,5 mm	1	42	917.1406	1/4" Hexagonal socket, 6 mm	1	66	911.1461	1/4" Bit socket Torx tamperproof, TB8	1
				43	917.1407	1/4" Hexagonal socket, 7 mm	1	67	911.1485	1/4" Bit socket Torx tamperproof, TB9	1
				44	917.1408	1/4" Hexagonal socket, 8 mm	1	68	911.1462	1/4" Bit socket Torx tamperproof, TB10	1
				45	917.1409	1/4" Hexagonal socket, 9 mm	1	69	911.1463	1/4" Bit socket Torx tamperproof, TB15	1

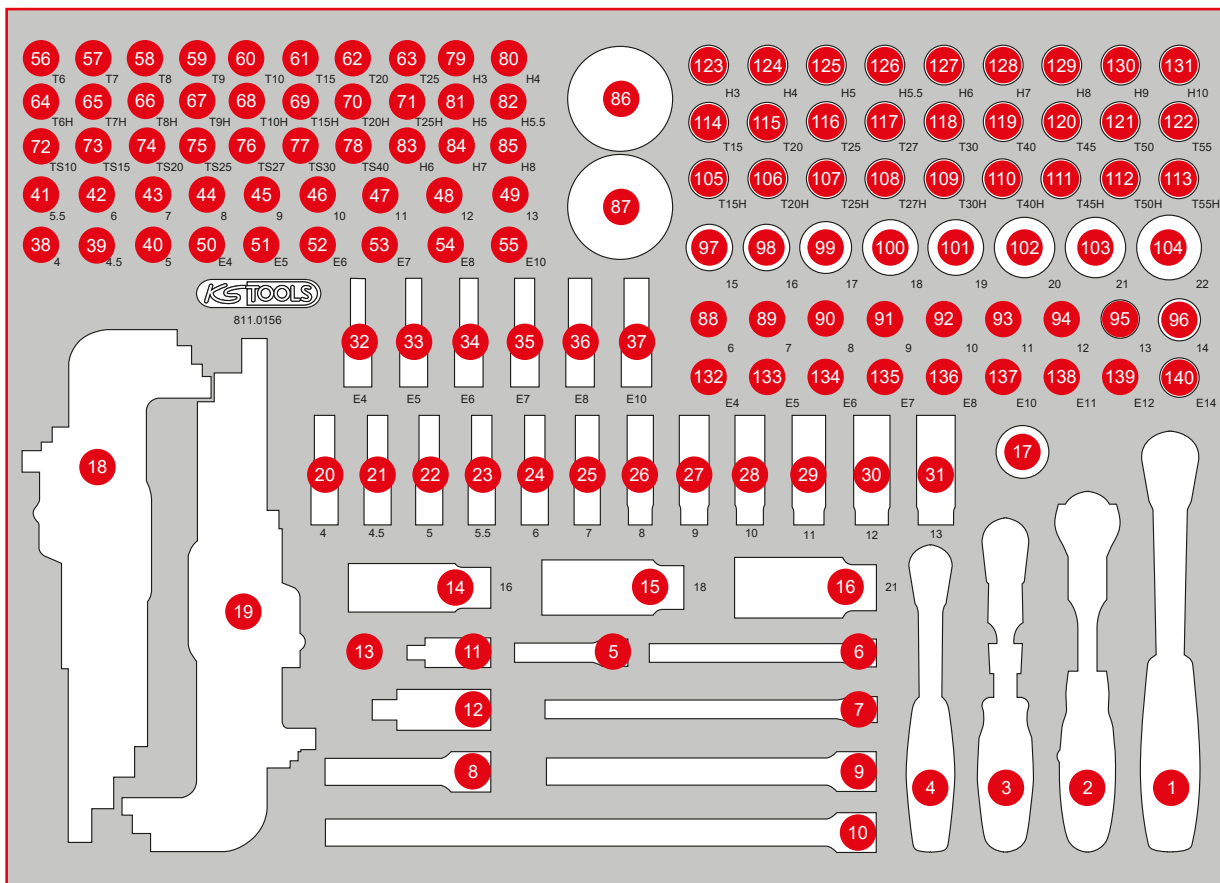

Pos.	Code	Description	pcs	Pos.	Code	Description	pcs	Pos.	Code	Description	pcs
70	911.1464	1/4" Bit socket Torx tamperproof, TB20	1	94	917.3812	3/8" Hexagonal socket, 12 mm	1	118	911.3873	3/8" Bit socket Torx, T30	1
71	911.1465	1/4" Bit socket Torx tamperproof, TB25	1	95	917.3813	3/8" Hexagonal socket, 13 mm	1	119	911.3874	3/8" Bit socket Torx, T40	1
72	911.1701	1/4" Bit socket five star tamperproof, TS10	1	96	917.3814	3/8" Hexagonal socket, 14 mm	1	120	911.3885	3/8" Bit socket Torx, T45	1
73	911.1702	1/4" Bit socket five star tamperproof, TS15	1	97	917.3815	3/8" Hexagonal socket, 15 mm	1	121	911.3884	3/8" Bit socket Torx, T50	1
74	911.1703	1/4" Bit socket five star tamperproof, TS20	1	98	917.3816	3/8" Hexagonal socket, 16 mm	1	122	911.3888	3/8" Bit socket Torx, T55	1
75	911.1704	1/4" Bit socket five star tamperproof, TS25	1	99	917.3817	3/8" Hexagonal socket, 17 mm	1	123	911.3863	3/8" Bit socket hexagon, 3 mm	1
76	911.1705	1/4" Bit socket five star tamperproof, TS27	1	100	917.3818	3/8" Hexagonal socket, 18 mm	1	124	911.3864	3/8" Bit socket hexagon, 4 mm	1
77	911.1706	1/4" Bit socket five star tamperproof, TS30	1	101	917.3819	3/8" Hexagonal socket, 19 mm	1	125	911.3865	3/8" Bit socket hexagon, 5 mm	1
78	911.1707	1/4" Bit socket five star tamperproof, TS40	1	102	917.3820	3/8" Hexagonal socket, 20 mm	1	126	911.38655	3/8" Bit socket hexagon, 5,5 mm	1
79	911.1436	1/4" Bit socket hexagon, 3 mm	1	103	917.3821	3/8" Hexagonal socket, 21 mm	1	127	911.3866	3/8" Bit socket hexagon, 6 mm	1
80	911.1437	1/4" Bit socket hexagon, 4 mm	1	104	917.3822	3/8" Hexagonal socket, 22 mm	1	128	911.3867	3/8" Bit socket hexagon, 7 mm	1
81	911.1438	1/4" Bit socket hexagon, 5 mm	1	105	911.3961	3/8" Bit socket Torx tamperproof, TB15	1	129	911.3868	3/8" Bit socket hexagon, 8 mm	1
82	911.14385	1/4" Bit socket hexagon, 5,5 mm	1	106	911.3962	3/8" Bit socket Torx tamperproof, TB20	1	130	917.3969	3/8" Bit socket hexagon, 9 mm	1
83	911.1439	1/4" Bit socket hexagon, 6 mm	1	107	911.3963	3/8" Bit socket Torx tamperproof, TB25	1	131	917.3857	3/8" Bit socket hexagon, 10 mm	1
84	911.1440	1/4" Bit socket hexagon, 7 mm	1	108	911.3964	3/8" Bit socket Torx tamperproof, TB27	1	132	911.4338	3/8" Torx E Socket, E4	1
85	911.1441	1/4" Bit socket hexagon, 8 mm	1	109	911.3965	3/8" Bit socket Torx tamperproof, TB30	1	133	911.4339	3/8" Torx E Socket, E5	1
86	914.1410	Mini hand reversible ratchet, 1/4", 72 teethh	1	110	911.3966	3/8" Bit socket Torx tamperproof, TB40	1	134	911.4340	3/8" Torx E Socket, E6	1
87	914.3810	Mini hand reversible ratchet, 3/8", 72 teethh	1	111	911.3967	3/8" Bit socket Torx tamperproof, TB45	1	135	911.4341	3/8" Torx E Socket, E7	1
88	917.3806	3/8" Hexagonal socket, 6 mm	1	112	911.3968	3/8" Bit socket Torx tamperproof, TB50	1	136	911.4342	3/8" Torx E Socket, E8	1
89	917.3807	3/8" Hexagonal socket, 7 mm	1	113	911.3969	3/8" Bit socket Torx tamperproof, TB55	1	137	911.4318	3/8" Torx E Socket, E10	1
90	917.3808	3/8" Hexagonal socket, 8 mm	1	114	911.3869	3/8" Bit socket Torx, T15	1	138	911.4319	3/8" Torx E Socket, E11	1
91	917.3809	3/8" Hexagonal socket, 9 mm	1	115	911.3870	3/8" Bit socket Torx, T20	1	139	911.4320	3/8" Torx E Socket, E12	1
92	917.3810	3/8" Hexagonal socket, 10 mm	1	116	911.3871	3/8" Bit socket Torx, T25	1	140	911.4321	3/8" Torx E Socket, E14	1
93	917.3811	3/8" Hexagonal socket, 11 mm	1	117	911.3872	3/8" Bit socket Torx, T27	1				

811.0066

M 1/2" Socket spanner set



Pos.	Code	Description	pcs	Pos.	Code	Description	pcs	Pos.	Code	Description	pcs
1	911.1306	1/2" Bit socket hexagon, short, 6 mm	1	12	911.1363	1/2" Bit socket Torx, T27	1	23	911.4333	1/2" Torx E Socket, E10	1
2	911.1307	1/2" Bit socket hexagon, short, 7 mm	1	13	911.1364	1/2" Bit socket Torx, T30	1	24	911.4334	1/2" Torx E Socket, E11	1
3	911.1308	1/2" Bit socket hexagon, short, 8 mm	1	14	911.1365	1/2" Bit socket Torx, T40	1	25	911.4335	1/2" Torx E Socket, E12	1
4	911.1309	1/2" Bit socket hexagon, short, 9 mm	1	15	911.1366	1/2" Bit socket Torx, T45	1	26	911.4336	1/2" Torx E Socket, E14	1
5	911.1310	1/2" Bit socket hexagon, short, 10 mm	1	16	911.1367	1/2" Bit socket Torx, T50	1	27	911.4322	1/2" Torx E Socket, E16	1
6	911.1312	1/2" Bit socket hexagon, short, 12 mm	1	17	911.1368	1/2" Bit socket Torx, T55	1	28	911.4323	1/2" Torx E Socket, E18	1
7	911.1314	1/2" Bit socket hexagon, short, 14 mm	1	18	911.1369	1/2" Bit socket Torx, T60	1	29	911.4324	1/2" Torx E Socket, E20	1
8	911.1317	1/2" Bit socket hexagon, short, 17 mm	1	19	911.1374	1/2" Bit socket Torx tamperproof, TB30	1	30	911.4325	1/2" Torx E Socket, E22	1
9	911.1319	1/2" Bit socket hexagon, short, 19 mm	1	20	911.1375	1/2" Bit socket Torx tamperproof, TB40	1	31	911.4326	1/2" Torx E Socket, E24	1
10	911.1361	1/2" Bit socket Torx, T20	1	21	911.1376	1/2" Bit socket Torx tamperproof, TB45	1	32	911.3892	Adaptor, 3/8" Fx1/2" M	1
11	911.1362	1/2" Bit socket Torx, T25	1	22	911.1377	1/2" Bit socket Torx tamperproof, TB50	1	33	911.1233	Reducing adaptor, 1/2" F x 3/8" M	1

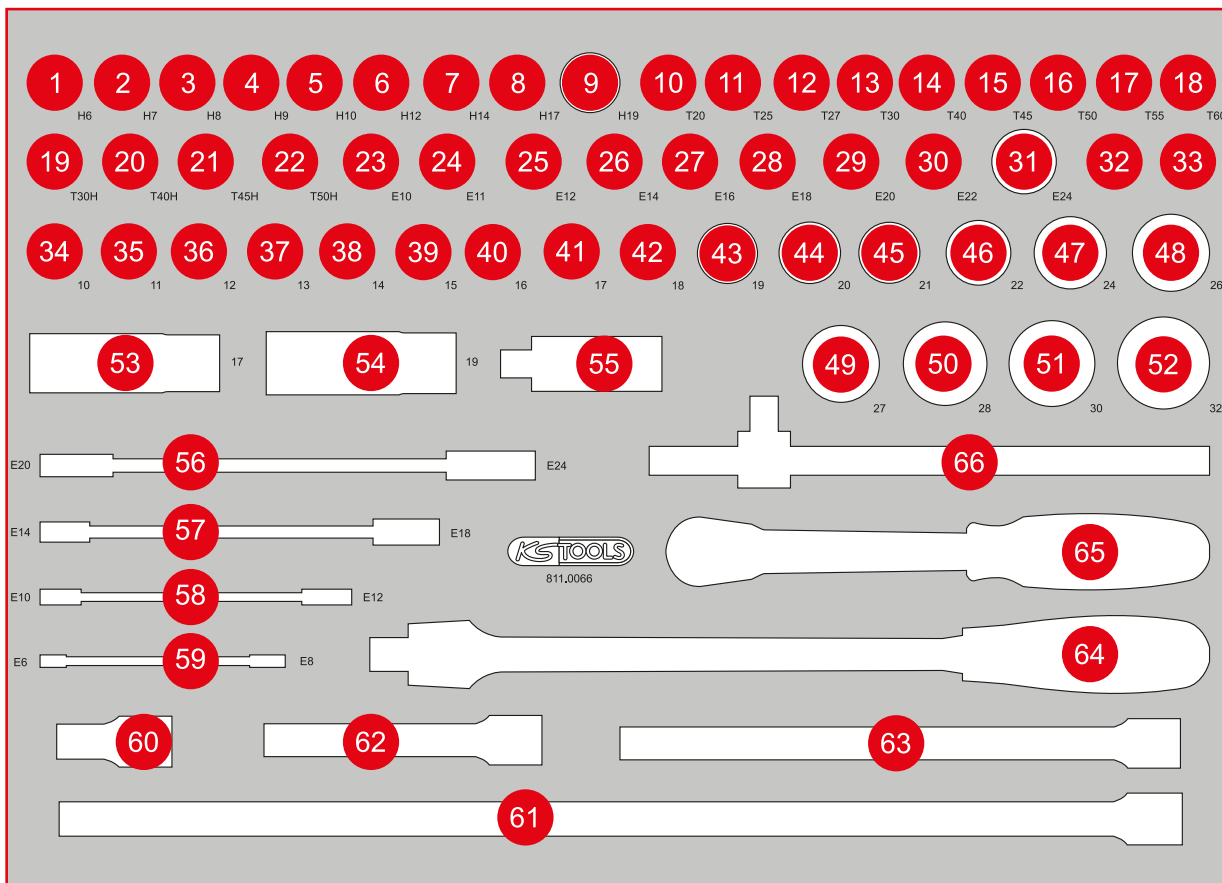

Pos.	Code	Description	pcs	Pos.	Code	Description	pcs	Pos.	Code	Description	pcs
34	917.1210	1/2" Hexagonal socket, 10 mm	1	45	917.1221	1/2" Hexagonal socket, 21 mm	1	56	911.0376	Double ring spanner for Torx E profile, E20 x E24	1
35	917.1211	1/2" Hexagonal socket, 11 mm	1	46	917.1222	1/2" Hexagonal socket, 22 mm	1	57	911.0374	Double ring spanner for Torx E profile, E14 x E18	1
36	917.1212	1/2" Hexagonal socket, 12 mm	1	47	917.1224	1/2" Hexagonal socket, 24 mm	1	58	911.0373	Double ring spanner for Torx E profile, E10 x E12	1
37	917.1213	1/2" Hexagonal socket, 13 mm	1	48	917.1343	1/2" Hexagonal socket, 26 mm	1	59	911.0371	Double ring spanner for Torx E profile, E6 x E8	1
38	917.1214	1/2" Hexagonal socket, 14 mm	1	49	917.1227	1/2" Hexagonal socket, 27 mm	1	60	911.1381	Wobble extension, 1/2", 50 mm	1
39	917.1215	1/2" Hexagonal socket, 15 mm	1	50	917.1344	1/2" Hexagonal socket, 28 mm	1	61	911.1836	Wobble extension, 1/2", 500 mm	1
40	917.1216	1/2" Hexagonal socket, 16 mm	1	51	917.1230	1/2" Hexagonal socket, 30 mm	1	62	911.1202	1/2" Extensions, 125 mm	1
41	917.1217	1/2" Hexagonal socket, 17 mm	1	52	917.1232	1/2" Hexagonal socket, 32 mm	1	63	911.1203	1/2" Extensions, 250 mm	1
42	917.1218	1/2" Hexagonal socket, 18 mm	1	53	515.0992	SlimPOWER 1/2" Alloy rim impact socket, 17 mm	1	64	917.1455	1/2" Flexi head drive handle	1
43	917.1219	1/2" Hexagonal socket, 19 mm	1	54	515.0993	SlimPOWER 1/2" Alloy rim impact socket, 19 mm	1	65	920.1290	1/2" SlimPOWER Reversible ratchet, 72 teeth	1
44	917.1220	1/2" Hexagonal socket, 20 mm	1	55	911.1250	1/2" Universal joint	1	66	911.1204	Sliding T-bar, 1/2", 250 mm	1

M 1/2" Socket spanner and screwdriver bit set

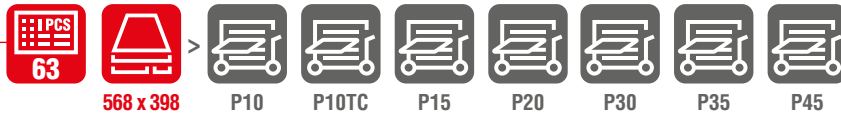

Pos.	Code	Description	pcs	Pos.	Code	Description	pcs	Pos.	Code	Description	pcs
1	917.1240	1/2" Hexagonal socket, deep, 10 mm	1	12	917.1259	1/2" Hexagonal socket, deep, 21 mm	1	23	911.4431	1/2" Torx E Socket, deep, E24	1
2	917.1241	1/2" Hexagonal socket, deep, 11 mm	1	13	917.1252	1/2" Hexagonal socket, deep, 22 mm	1	24	917.1337	1/2" Hexagonal socket, deep, 26 mm	1
3	917.1242	1/2" Hexagonal socket, deep, 12 mm	1	14	917.1315	1/2" Hexagonal socket, deep, 23 mm	1	25	917.1254	1/2" Hexagonal socket, deep, 27 mm	1
4	917.1243	1/2" Hexagonal socket, deep, 13 mm	1	15	917.1257	1/2" Hexagonal socket, deep, 24 mm	1	26	917.1338	1/2" Hexagonal socket, deep, 28 mm	1
5	917.1244	1/2" Hexagonal socket, deep, 14 mm	1	16	911.4423	1/2" Torx E Socket, 78 mm long, E10	1	27	917.1255	1/2" Hexagonal socket, deep, 30 mm	1
6	917.1245	1/2" Hexagonal socket, deep, 15 mm	1	17	911.4424	1/2" Torx E Socket, deep, E11	1	28	917.1256	1/2" Hexagonal socket, deep, 32 mm	1
7	917.1246	1/2" Hexagonal socket, deep, 16 mm	1	18	911.4425	1/2" Torx E Socket, 78 mm, E12	1	29	917.1296	1/2" Bit socket Torx tamperproof, long, TB30	1
8	917.1247	1/2" Hexagonal socket, deep, 17 mm	1	19	911.4426	1/2" Torx E Socket, 78 mm, E14	1	30	917.1297	1/2" Bit socket Torx tamperproof, long, TB40	1
9	917.1248	1/2" Hexagonal socket, deep, 18 mm	1	20	911.4427	1/2" Torx E Socket, 78 mm, E16	1	31	917.1298	1/2" Bit socket Torx tamperproof, long, TB45	1
10	917.1249	1/2" Hexagonal socket, deep, 19 mm	1	21	911.4428	1/2" Torx E Socket, 78 mm, E18	1	32	917.1299	1/2" Bit socket Torx tamperproof, long, TB50	1
11	917.1258	1/2" Hexagonal socket, deep, 20 mm	1	22	911.4429	1/2" Torx E Socket, 78 mm, E20	1	33	917.1251	1/2" Bit socket Torx tamperproof, long, TB55	1

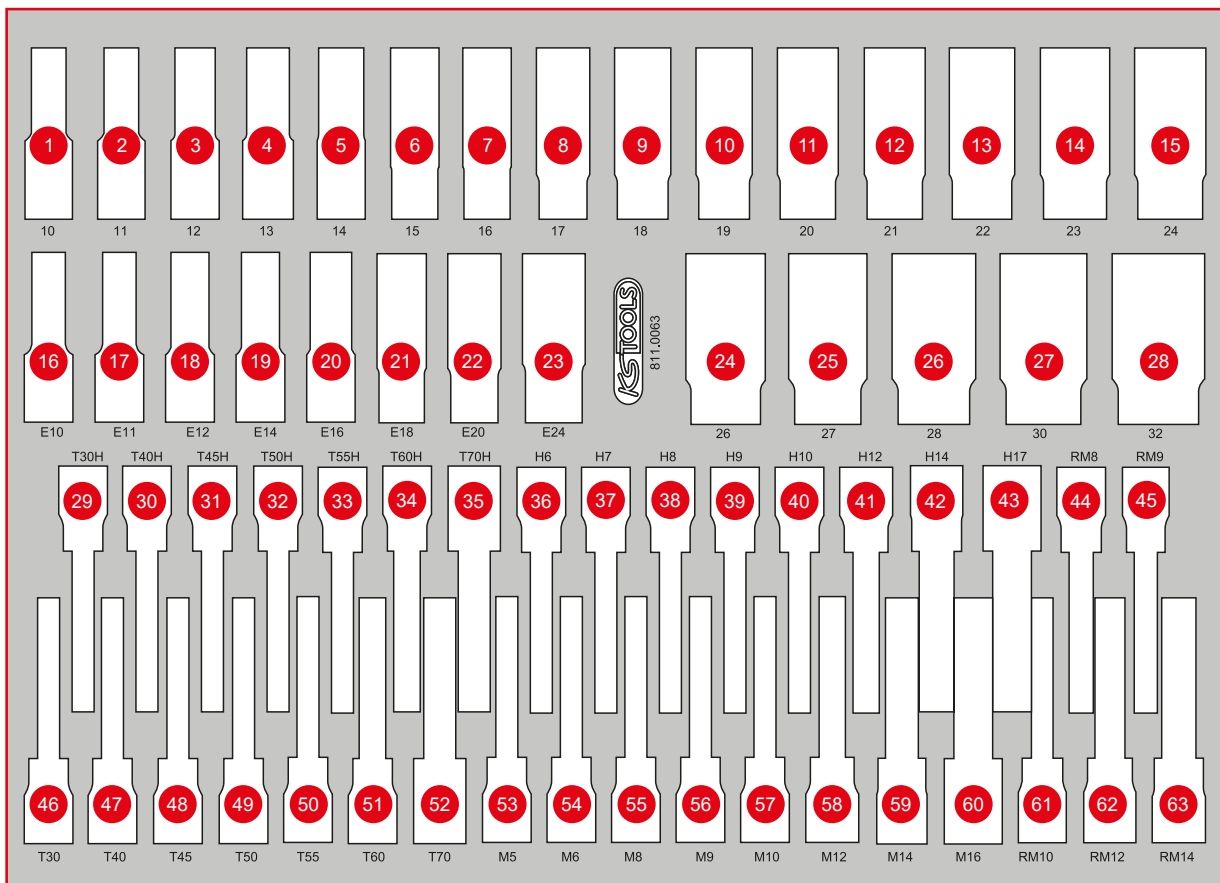

Pos.	Code	Description	pcs	Pos.	Code	Description	pcs	Pos.	Code	Description	pcs
34	917.1253	1/2" Bit socket Torx tamperproof, long, TB60	1	45	911.1925	1/2" Bit socket RIBE, M9, 110 mm	1	56	911.1359	1/2" Bit socket spline (XZN), M9, 110 mm	1
35	917.1304	1/2" Bit socket Torx tamperproof, long, TB70	1	46	911.1524	1/2" Bit socket Torx, long, T30	1	57	911.1353	1/2" Bit socket spline (XZN), M10, 110 mm	1
36	911.1326	1/2" Bit socket hexagon, long, 6 mm	1	47	911.1525	1/2" Bit socket Torx, long, T40	1	58	911.1354	1/2" Bit socket spline (XZN), M12, 110 mm	1
37	911.1327	1/2" Bit socket hexagon, long, 7 mm	1	48	911.1526	1/2" Bit socket Torx, long, T45	1	59	911.1355	1/2" Bit socket spline (XZN), M14, 110 mm	1
38	911.1328	1/2" Bit socket hexagon, long, 8 mm	1	49	911.1527	1/2" Bit socket Torx, long, T50	1	60	911.1356	1/2" Bit socket spline (XZN), M16, 110 mm	1
39	911.1329	1/2" Bit socket hexagon, long, 9 mm	1	50	911.1528	1/2" Bit socket Torx, long, T55	1	61	911.1926	1/2" Bit socket RIBE, M10, 110 mm	1
40	911.1330	1/2" Bit socket hexagon, long, 10 mm	1	51	911.1529	1/2" Bit socket Torx, long, T60	1	62	911.1995	1/2" Bit socket RIBE, M12, 110 mm	1
41	911.1332	1/2" Bit socket hexagon, long, 12 mm	1	52	911.1517	1/2" Bit socket Torx, long, T70	1	63	911.1997	1/2" Bit socket RIBE, M14, 110 mm	1
42	917.1332	1/2" Bit socket hexagon, long, 14 mm	1	53	911.1350	1/2" Bit socket spline (XZN), M5, 110 mm	1				
43	911.1337	1/2" Bit socket hexagon, long, 17 mm	1	54	911.1351	1/2" Bit socket spline (XZN), M6, 110 mm	1				
44	911.1924	1/2" Bit socket RIBE, M8, 110 mm	1	55	911.1352	1/2" Bit socket spline (XZN), M8, 110 mm	1				

811.2041

M Screw spanner set

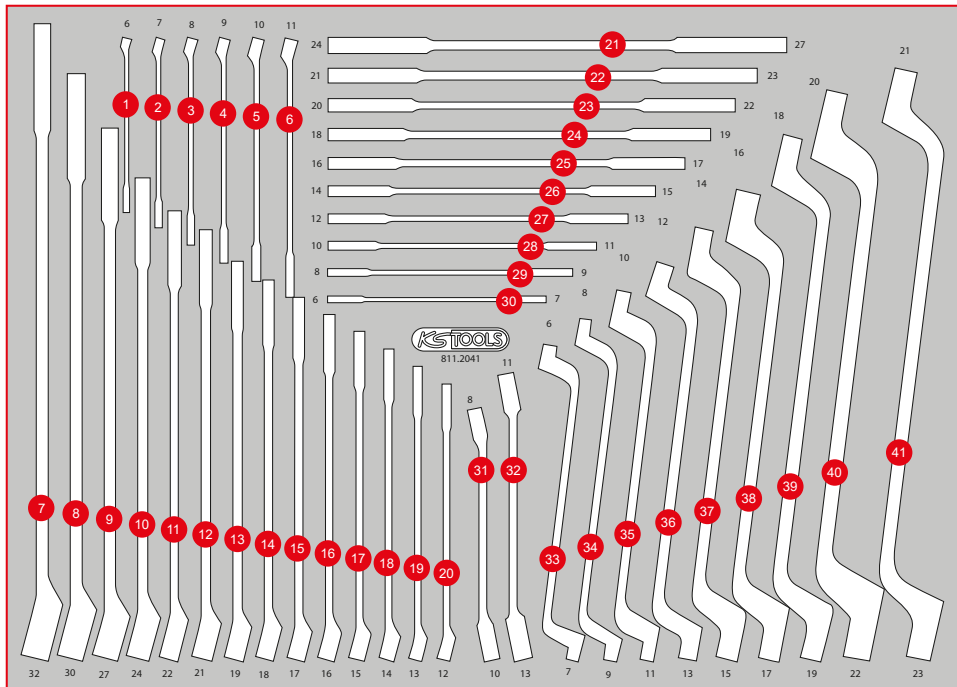

Pos.	Code	Description	pcs
1	517.0606	Combination spanners, offset, 6 mm	1
2	517.0607	Combination spanners, offset, 7 mm	1
3	517.0608	Combination spanners, offset, 8 mm	1
4	517.0609	Combination spanners, offset, 9 mm	1
5	517.0610	Combination spanners, offset, 10 mm	1
6	517.0611	Combination spanners, offset, 11 mm	1
7	517.0632	Combination spanners, offset, 32 mm	1
8	517.0630	Combination spanners, offset, 30 mm	1
9	517.0627	Combination spanners, offset, 27 mm	1
10	517.0624	Combination spanners, offset, 24 mm	1
11	517.0622	Combination spanners, offset, 22 mm	1
12	517.0621	Combination spanners, offset, 21 mm	1
13	517.0619	Combination spanners, offset, 19 mm	1
14	517.0618	Combination spanners, offset, 18 mm	1
15	517.0617	Combination spanners, offset, 17 mm	1
16	517.0616	Combination spanners, offset, 16 mm	1
17	517.0615	Combination spanners, offset, 15 mm	1
18	517.0614	Combination spanners, offset, 14 mm	1
19	517.0613	Combination spanners, offset, 13 mm	1
20	517.0612	Combination spanners, offset, 12 mm	1
21	517.0716	Double open ended spanners, 24 x 27 mm	1
22	517.0715	Double open ended spanners, 21 x 23 mm	1
23	517.0714	Double open ended spanners, 20 x 22 mm	1
24	517.0712	Double open ended spanners, 18 x 19 mm	1
25	517.0710	Double open ended spanners, 16 x 17 mm	1
26	517.0709	Double open ended spanners, 14 x 15 mm	1
27	517.0707	Double open ended spanners, 12 x 13 mm	1
28	517.0704	Double open ended spanners, 10 x 11 mm	1
29	517.0702	Double open ended spanners, 8 x 9 mm	1
30	517.0701	Double open ended spanners, 6 x 7 mm	1
31	517.0252	Open double ring spanner, offset, 8 x 10 mm	1
32	517.9244	Open double ring spanner, offset, 11 x 13 mm	1
33	517.0801	Double ring spanner, offset, 6 x 7 mm	1
34	517.0802	Double ring spanner, offset, 8 x 9 mm	1
35	517.0804	Double ring spanner, offset, 10 x 11 mm	1
36	517.0807	Double ring spanner, offset, 12 x 13 mm	1
37	517.0809	Double ring spanner, offset, 14 x 15 mm	1
38	517.0810	Double ring spanner, offset, 16 x 17 mm	1
39	517.0812	Double ring spanner, offset, 18 x 19 mm	1
40	517.0813	Double ring spanner, offset, 20 x 22 mm	1
41	517.0815	Double ring spanner, offset, 21 x 23 mm	1

811.1032

M Screwdriver and spanner set

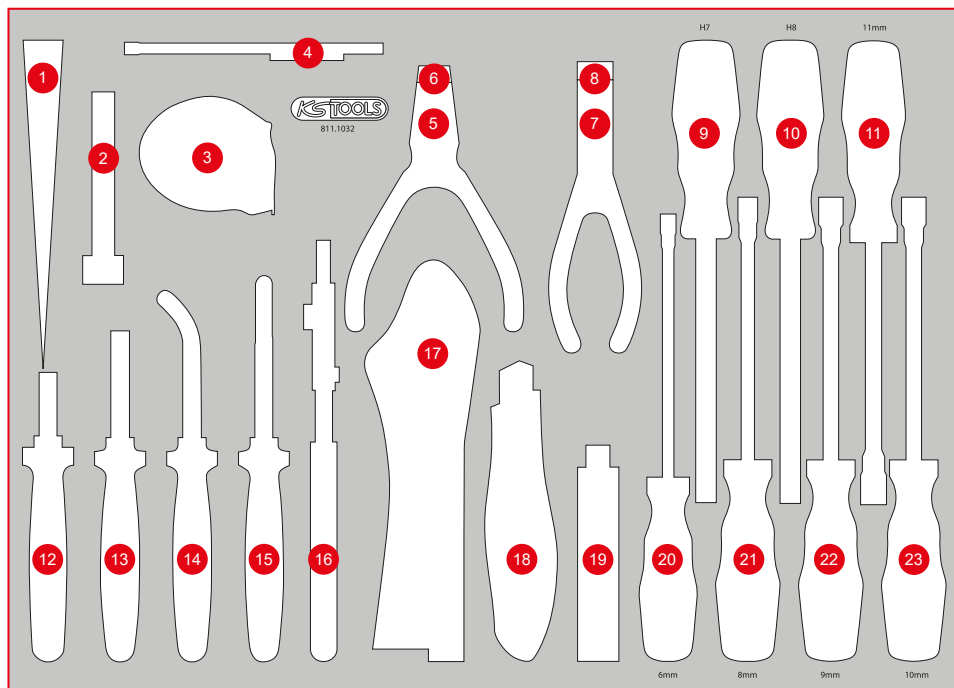

Pos.	Code	Description	pcs
1	911.8138	Trim plastic wedge, 195 x3 0 mm	1
2	300.0600	Feeler gauge, 20 Blades, 0,05 - 1 mm	1
3	300.0114	Tape measure with locking device and belt clip, black red, 5 m, 19 mm	1
4	550.1001	2 in1 Telescopic solenoid holder with washer jet cleaning and setting tool, 150 - 675 mm	1
5	500.1029	Circlip pliers for external circlips, 160 mm	1
6	500.1026	Circlip pliers for external circlips, angled, 160 mm	1
7	500.1035	Circlip pliers for internal circlips, 160 mm	1
8	500.1032	Circlip pliers for internal circlips, angled, 160 mm	1
9	159.1127	ERGOTORQUEplus Socket screwdriver, 7 mm	1
10	911.1128	ERGOTORQUE Socket screwdriver, 8 mm	1
11	159.1209	ERGOTORQUEplus Socket screwdriver, 11 mm	1
12	115.1012	ERGOTORQUE diagonal side cutter, 160 mm	1
13	115.1021	ERGOTORQUE combination pliers, 180 mm	1
14	115.1019	ERGOTORQUE bent nose pliers serrated, 210 mm	1
15	115.1024	ERGOTORQUE long nose pliers serrated cutter, 200 mm	1
16	115.2010	Water pump pliers, 240 mm	1
17	115.1033	Self grip wrench, 220 mm	1
18	907.2135	Universal snap off blade knife 18 mm	1
19	907.2166	Snap off blades 0,5 x 18 x 100 mm, dispenser with 10 pieces	10
20	159.1204	ERGOTORQUEplus Socket screwdriver, 6 mm	1
21	159.1206	ERGOTORQUEplus Socket screwdriver, 8 mm	1
22	159.1207	ERGOTORQUEplus Socket screwdriver, 9 mm	1
23	159.1208	ERGOTORQUEplus Socket screwdriver, 10 mm	1

811.0021

M Hammer, chisel and file set



Pos.	Code	Description	pcs
1	140.5252	Recoil free soft faced Hammer, 400 g	1
2	142.1402	Fitters Hammer, fiberglas handle, 400 g	1
3	142.5101	Club Hammer, fiberglas handle, 1000 g	1
4	156.0242	Cross chisel, octagon, 7 mm	1
5	156.0234	Pin punch, Ø 6 mm, cylindrical shaft	1
6	156.0233	Pin punch, Ø 5 mm, cylindrical shaft	1
7	156.0232	Pin punch, cylindrical shaft, 4 mm	1
8	156.0231	Pin punch, cylindrical shaft, 3 mm	1
9	300.0510	Pocket vernier calliper 0-150 mm, 235 mm	1
10	157.0405	Tri-bastard file, form C, cut 2, 200 mm	1
11	157.0960	Brake saddle file, extra narrow, 270 mm	1
12	157.0205	Round file, form F, cut 2, 200 mm	1
13	156.0243	Centre punch, octagon 10 mm	1
14	156.0238	Punch, Ø 4 mm, conical	1
15	156.0237	Punch, Ø 3 mm, conical	1
16	156.0252	Flat chisel, octagon, 12 mm	1
17	156.0253	Flat chisel, octagon, 16 mm	1
18	156.0254	Flat chisel, octagon, 18 mm	1
19	156.0241	Flat chisel, octagon, 20 mm	1
20	201.2335	Steel wire brake saddle brush, 2-row, straight	1
21	300.0104	Flexible steel rule, 300 mm	1

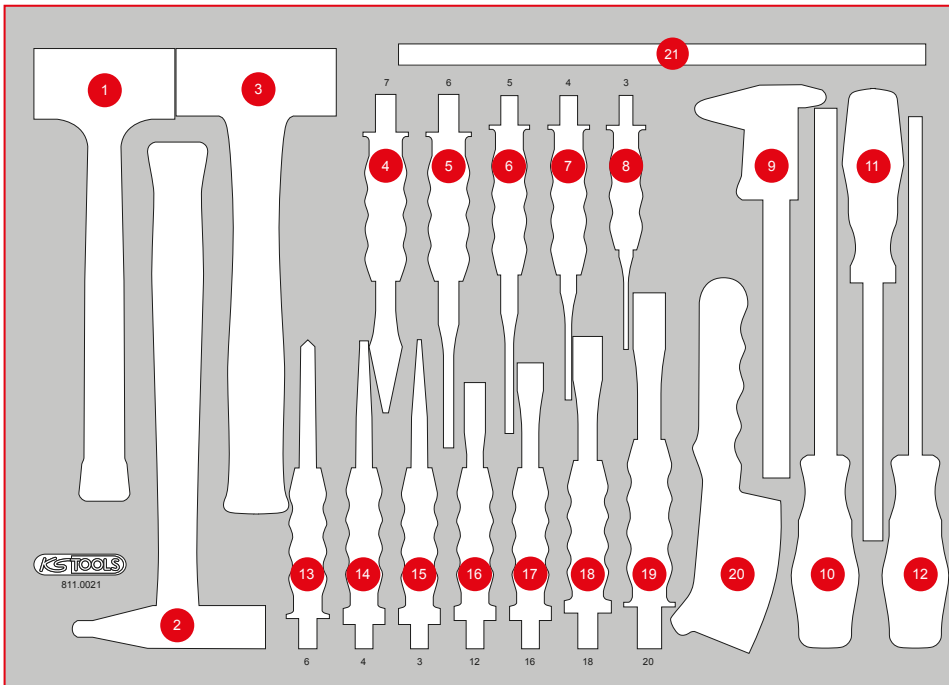

P15

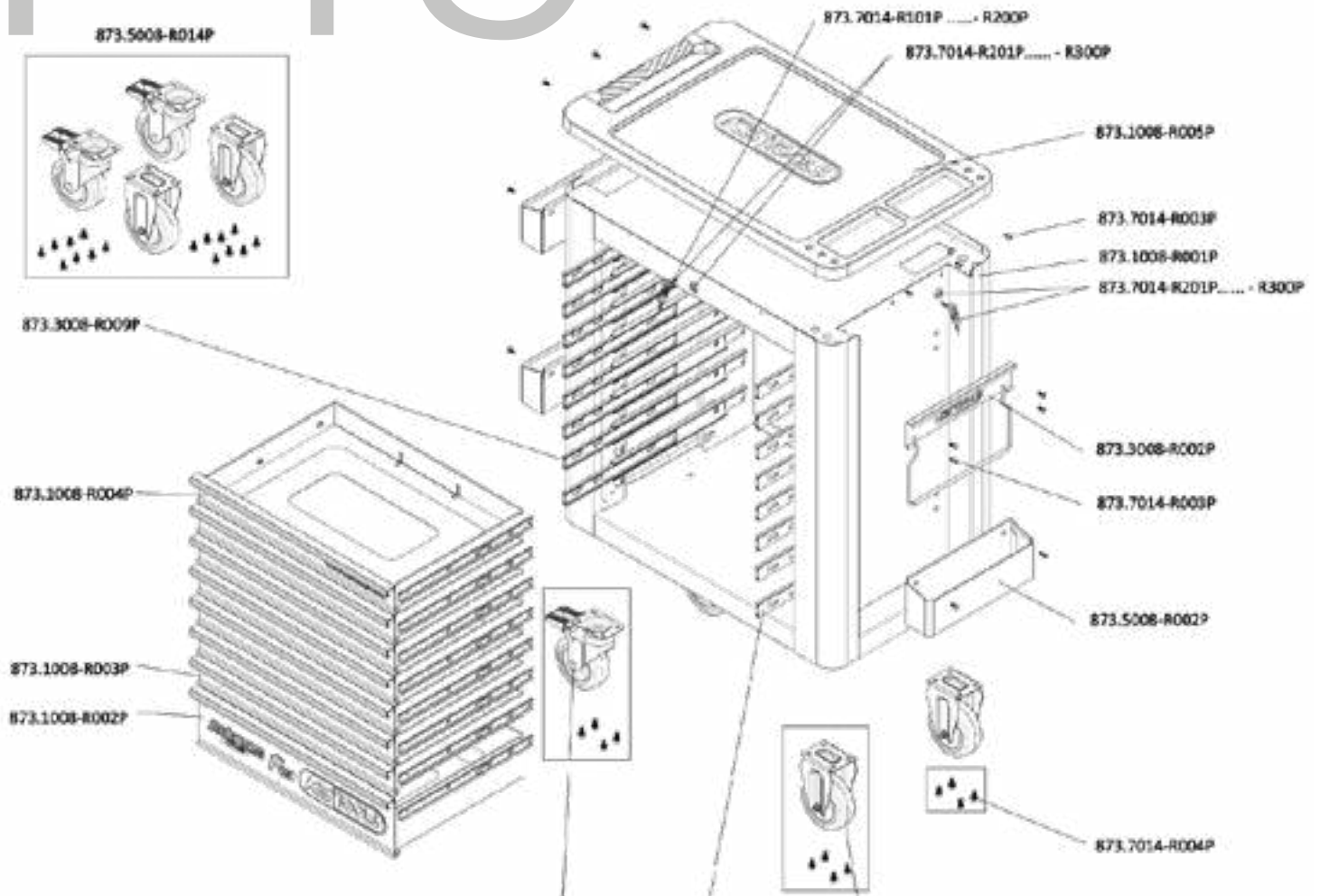

INDIVIDUAL PARTS LIST

Art.-Nr.	Description	amount
873.7014-R101P...	Replacement key for PERFORMANCEplus workshop trolley lock number xyz	2
873.7014-R201P...	Lock with 2 keys for PERFORMANCEplus workshop trolley lock number xyz	2
873.1008-R001P	Body of workshop trolley	1
873.1008-R002P	Compartment with logo and ball-bearing guide, 568x398x145 mm	1
873.1008-R003P	Compartment with ball-bearing guide, for workshop trolley P10/P10TC/P15, 568x398x65 mm	6
873.1008-R004P	Compartment with website and ball-bearing guide, for workshop trolley P10/P15, 568x398x65 mm	1
873.1008-R005P	Plastic work surface with handle	1
873.3008-R002P	Paper roll holder for PERFORMANCEplus workshop trolley P10/P15/P25	1
873.3008-R008P	Full extension (with ball-bearing guide) with automatic retraction	8
873.3008-R009P	Full extension (with ball-bearing guide) with automatic retraction	8
873.5008-R002P	Can holder for PERFORMANCEplus workshop trolley P10/P15/P25/P35	3
873.5008-R009P	Fixed castors for PERFORMANCEplus workshop trolley, incl. screws	2
873.5008-R011P	Swivel castors with brakes, for PERFORMANCEplus workshop trolley, incl. screws	2
873.5008-R014P	Roller set for PERFORMANCEplus workshop trolley, incl. screws	1
873.7014-R003P	M6x12 screw (1 pcs.) for PERFORMANCEplus workshop trolley accessories	16
873.7014-R004P	M8 screws for PERFORMANCEplus workshop trolley rollers (16 pcs.)	1



873.7014-R101P...R200P
Replacement key for lock number xyz



873.7014-R201P...R300P
Lock with 2 keys, lock number xyz



873.3008-R008P
Full extension (with ball-bearing guide) with automatic retraction, right



873.3008-R009P
Full extension (with ball-bearing guide) with automatic retraction, left



873.5008-R009P
Fixed castors, incl. screws



873.5008-R011P
Swivel castors with brakes, incl. screws



873.5008-R014P
Roller set, incl. screws



873.1008-R005P
Plastic work surface with handle



873.1008-R004P
Compartment with website and ball-bearing guide, 568x398x65 mm



873.1008-R003P
Compartment with ball-bearing guide, 568x398x65 mm



873.1008-R002P
Compartment with logo and ball-bearing guide, 568x398x145 mm



873.5008-R002P
Can holder including screws, W = 310 mm



873.3008-R002P
Paper roll holder including screws, W= 320 mm



873.7014-R004P
M8 screws (16 pcs.)



873.7014-R003P
M6x12 screw (1 pcs.)



873.1008-R001P
Body of workshop trolley



The only thing that can't be replaced is the quality!