

# P25

**workshop tool trolley**  
with 706 tools for 7 drawers  
**825.4285**

# PRECIOUS WIDTH



**Workshop trolley P25**  
with 8 compartments  
873.3008



**DUO Lock** Brilliant locking system



**8 Drawers** each load capacity up to 50 kg

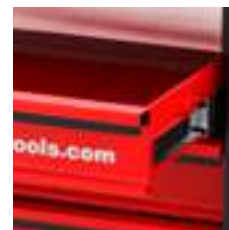

Stable **ball bearing**



**Stainless steel surface**



**Lock** lockable



**Anti-static castors** with brakes



Integrated **corner protection**



**Paper roll holder** included



**Can holder** included

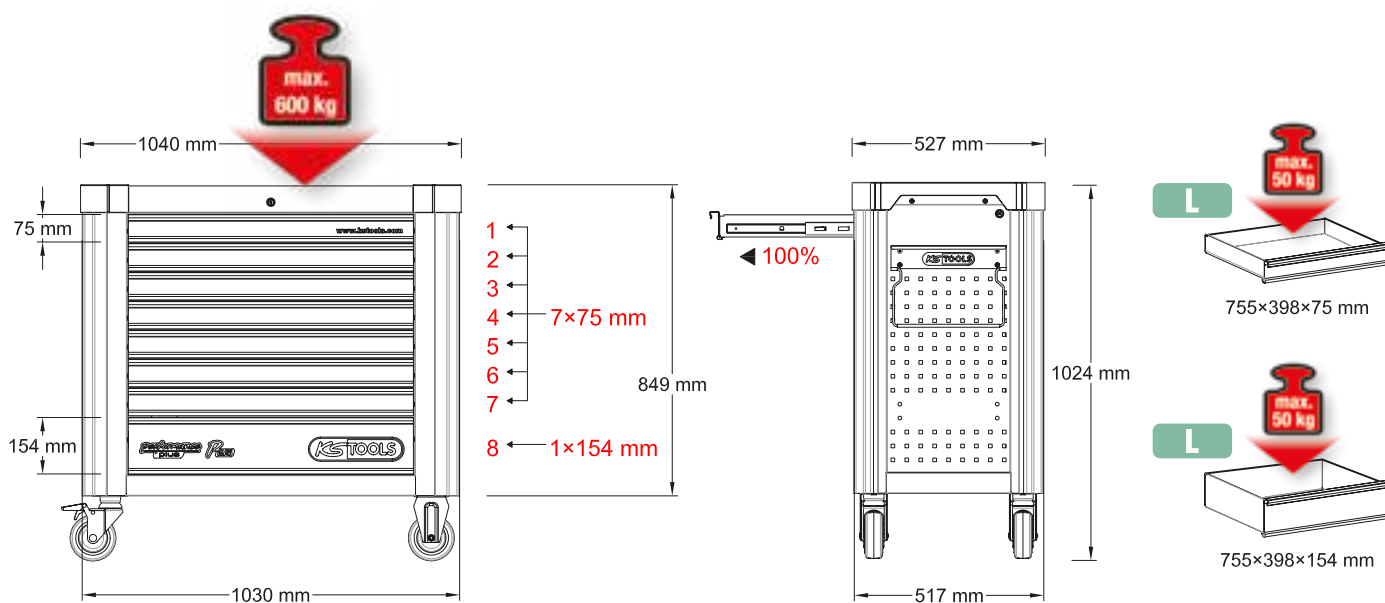

# P25 workshop tool trolley set with 285 tools for 4 drawers

825.4285

IPCS  
285  
L



IPCS  
30

Pliers and measuring tool set in foam insert

813.0030



IPCS  
156

1/4" + 3/8" + 1/2" socket spanner set in foam insert

813.0156



IPCS  
57

Screw spanner set in foam insert

813.0057



IPCS  
33

Screwdriver set in foam insert

813.0033

813.0030

**L** Pliers and measuring tool set

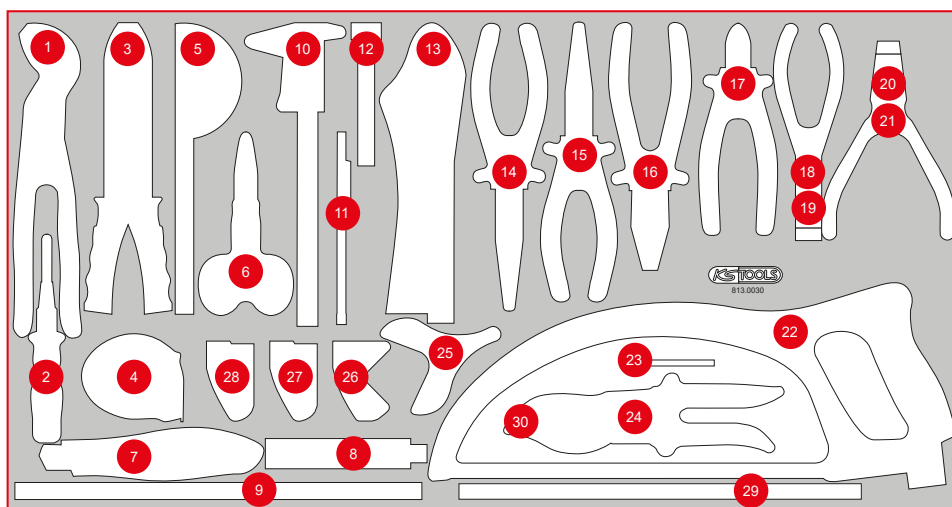

Pos.	Code	Description	pcs
1	115.2010	Water pump pliers, 240 mm	1
2	156.0466	Automatic centre punch, Ø 4 mm	1
3	115.1231	Multifunction pliers for insulated and non insulated cable terminals, 220 mm	1
4	300.0114	Tape measure with locking device and belt clip, black red, 5 m, 19 mm	1
5	300.0700	Protractor with rule, 220 mm	1
6	118.0013	Uni workshop scissors, 143 mm	1
7	907.2135	Universal snap off blade knife 18 mm	1
8	907.2166	Snap off blades 0,5 x 1 x 100 mm, dispenser 10 with 10 pieces	10
9	300.0104	Flexible steel rule, 300 mm	1
10	300.0510	Pocket vernier calliper 0-150 mm, 235 mm	1
11	550.1023	2in1 Telescopic solenoid lifter with washer jet cleaning and setting tool, 150-590 mm	1
12	300.0600	Feeler gauge, 20 Blades, 0,05 - 1 mm	1
13	115.1033	Self grip wrench, 220 mm	1
14	115.1024	ERGOTORQUE long nose pliers serrated cutter, 200 mm	1
15	115.1019	ERGOTORQUE bent nose pliers serrated, 210 mm	1
16	115.1021	ERGOTORQUE combination pliers, 180 mm	1
17	115.1012	ERGOTORQUE diagonal side cutter, 160 mm	1
18	500.1032	Circlip pliers for internal circlips, angled, 160 mm	1
19	500.1035	Circlip pliers for internal circlips, 160 mm	1
20	500.1026	Circlip pliers for external circlips, angled, 160 mm	1
21	500.1029	Circlip pliers for external circlips, 160 mm	1
22	907.2115	Hacksaw frame, 300 mm	1
23	151.2604	Hexagon key wrench phosphate finish, short, 4 mm	1
24	123.0076	Scissor-shaped with blades	1
25	123.0086	angular stop	1
26	123.0079	prism for 90° profile	1
27	123.0078	fitting for Ø 25 mm	1
28	123.0077	fitting for Ø 16 and 19 mm	1
29	129.6620-24	HSS Bi Co 8 metal high performance saw blades 1,0 mm	1
30	123.0084	straight fitting	1

813.0156

**L** 1/4" + 3/8" + 1/2" Socket spanner set



Pos.	Code	Description	pcs	Pos.	Code	Description	pcs	Pos.	Code	Description	pcs
1	911.3863	3/8" Bit socket hexagon, 3 mm	1	27	911.3969	3/8" Bit socket Torx tamperproof, TB55	1	53	911.4321	3/8" Torx E Socket, E14	1
2	911.3864	3/8" Bit socket hexagon, 4 mm	1	28	917.3815	3/8" Hexagonal socket, 15 mm	1	54	917.1222	1/2" Hexagonal socket, 22 mm	1
3	911.3865	3/8" Bit socket hexagon, 5 mm	1	29	917.3816	3/8" Hexagonal socket, 16 mm	1	55	917.1223	1/2" Hexagonal socket, 23 mm	1
4	911.38655	3/8" Bit socket hexagon, 5,5 mm	1	30	917.3817	3/8" Hexagonal socket, 17 mm	1	56	917.1224	1/2" Hexagonal socket, 24 mm	1
5	911.3866	3/8" Bit socket hexagon, 6 mm	1	31	917.3818	3/8" Hexagonal socket, 18 mm	1	57	917.1342	1/2" Hexagonal socket, 25 mm	1
6	911.3867	3/8" Bit socket hexagon, 7 mm	1	32	917.3819	3/8" Hexagonal socket, 19 mm	1	58	917.1343	1/2" Hexagonal socket, 26 mm	1
7	911.3868	3/8" Bit socket hexagon, 8 mm	1	33	917.3820	3/8" Hexagonal socket, 20 mm	1	59	917.1227	1/2" Hexagonal socket, 27 mm	1
8	917.3969	3/8" Bit socket hexagon, 9 mm	1	34	917.3821	3/8" Hexagonal socket, 21 mm	1	60	917.1344	1/2" Hexagonal socket, 28 mm	1
9	917.3857	3/8" Bit socket hexagon, 10 mm	1	35	917.3822	3/8" Hexagonal socket, 22 mm	1	61	917.1345	1/2" Hexagonal socket, 29 mm	1
10	911.3869	3/8" Bit socket Torx, T15	1	36	917.3806	3/8" Hexagonal socket, 6 mm	1	62	917.1230	1/2" Hexagonal socket, 30 mm	1
11	911.3870	3/8" Bit socket Torx, T20	1	37	917.3807	3/8" Hexagonal socket, 7 mm	1	63	917.1232	1/2" Hexagonal socket, 32 mm	1
12	911.3871	3/8" Bit socket Torx, T25	1	38	917.3808	3/8" Hexagonal socket, 8 mm	1	64	917.1210	1/2" Hexagonal socket, 10 mm	1
13	911.3872	3/8" Bit socket Torx, T27	1	39	917.3809	3/8" Hexagonal socket, 9 mm	1	65	917.1211	1/2" Hexagonal socket, 11 mm	1
14	911.3873	3/8" Bit socket Torx, T30	1	40	917.3810	3/8" Hexagonal socket, 10 mm	1	66	917.1212	1/2" Hexagonal socket, 12 mm	1
15	911.3874	3/8" Bit socket Torx, T40	1	41	917.3811	3/8" Hexagonal socket, 11 mm	1	67	917.1213	1/2" Hexagonal socket, 13 mm	1
16	911.3885	3/8" Bit socket Torx, T45	1	42	917.3812	3/8" Hexagonal socket, 12 mm	1	68	917.1214	1/2" Hexagonal socket, 14 mm	1
17	911.3884	3/8" Bit socket Torx, T50	1	43	917.3813	3/8" Hexagonal socket, 13 mm	1	69	917.1215	1/2" Hexagonal socket, 15 mm	1
18	911.3888	3/8" Bit socket Torx, T55	1	44	917.3814	3/8" Hexagonal socket, 14 mm	1	70	917.1216	1/2" Hexagonal socket, 16 mm	1
19	911.3961	3/8" Bit socket Torx tamperproof, TB15	1	45	911.4338	3/8" Torx E Socket, E4	1	71	917.1217	1/2" Hexagonal socket, 17 mm	1
20	911.3962	3/8" Bit socket Torx tamperproof, TB20	1	46	911.4339	3/8" Torx E Socket, E5	1	72	917.1218	1/2" Hexagonal socket, 18 mm	1
21	911.3963	3/8" Bit socket Torx tamperproof, TB25	1	47	911.4340	3/8" Torx E Socket, E6	1	73	917.1219	1/2" Hexagonal socket, 19 mm	1
22	911.3964	3/8" Bit socket Torx tamperproof, TB27	1	48	911.4341	3/8" Torx E Socket, E7	1	74	917.1220	1/2" Hexagonal socket, 20 mm	1
23	911.3965	3/8" Bit socket Torx tamperproof, TB30	1	49	911.4342	3/8" Torx E Socket, E8	1	75	917.1221	1/2" Hexagonal socket, 21 mm	1
24	911.3966	3/8" Bit socket Torx tamperproof, TB40	1	50	911.4318	3/8" Torx E Socket, E10	1	76	917.1340	1/2" Hexagonal socket, 8 mm	1
25	911.3967	3/8" Bit socket Torx tamperproof, TB45	1	51	911.4319	3/8" Torx E Socket, E11	1	77	917.1341	1/2" Hexagonal socket, 9 mm	1
26	911.3968	3/8" Bit socket Torx tamperproof, TB50	1	52	911.4320	3/8" Torx E Socket, E12	1	78	911.1233	1/2" Reducing adaptor, 1/2" F x 3/8" M	1

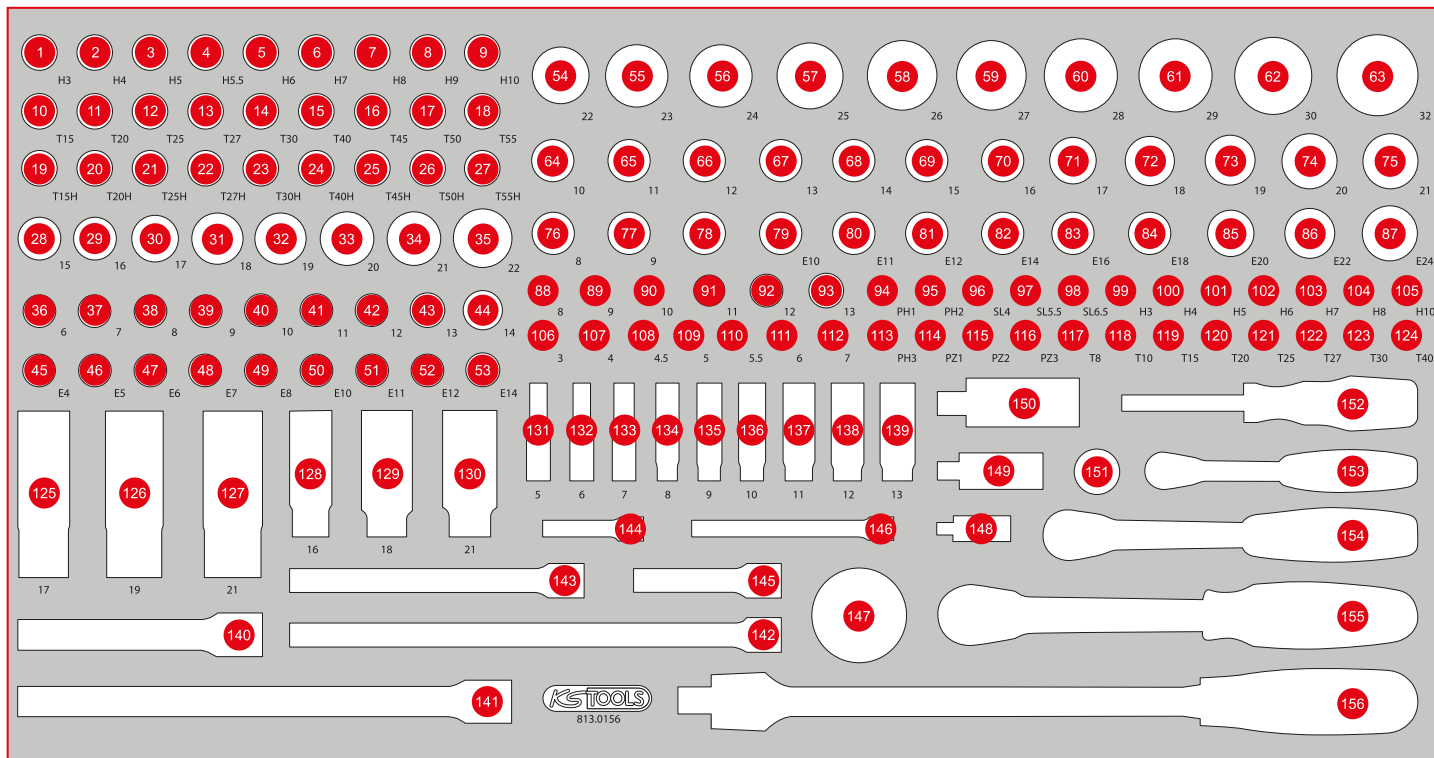

Pos.	Code	Description	pcs	Pos.	Code	Description	pcs	Pos.	Code	Description	pcs
79	911.4333	1/2" Torx E Socket, E10	1	106	917.1445	1/4" Classic Hexagonal socket, 3 mm	1	131	917.1527	1/4" Hexagonal socket, deep, 5 mm	1
80	911.4334	1/2" Torx E Socket, E11	1	107	917.1404	1/4" Hexagonal socket, 4 mm	1	132	917.1426	1/4" Hexagonal socket, deep, 6 mm	1
81	911.4335	1/2" Torx E Socket, E12	1	108	917.14045	1/4" Hexagonal socket, 4,5 mm	1	133	917.1427	1/4" Hexagonal socket, deep, 7 mm	1
82	911.4336	1/2" Torx E Socket, E14	1	109	917.1405	1/4" Hexagonal socket, 5 mm	1	134	917.1428	1/4" Hexagonal socket, deep, 8 mm	1
83	911.4322	1/2" Torx E Socket, E16	1	110	917.14055	1/4" Hexagonal socket, 5,5 mm	1	135	917.1429	1/4" Hexagonal socket, deep, 9 mm	1
84	911.4323	1/2" Torx E Socket, E18	1	111	917.1406	1/4" Hexagonal socket, 6 mm	1	136	917.1430	1/4" Hexagonal socket, deep, 10 mm	1
85	911.4324	1/2" Torx E Socket, E20	1	112	917.1407	1/4" Hexagonal socket, 7 mm	1	137	917.1431	1/4" Hexagonal socket, deep, 11 mm	1
86	911.4325	1/2" Torx E Socket, E22	1	113	911.1417	1/4" Bit socket, PH3	1	138	917.1432	1/4" Hexagonal socket, deep, 12 mm	1
87	911.4326	1/2" Torx E Socket, E24	1	114	911.1401	1/4" Bit socket, PZ1	1	139	917.1433	1/4" Hexagonal socket, deep, 13 mm	1
88	917.1408	1/4" Hexagonal socket, 8 mm	1	115	911.1402	1/4" Bit socket, PZ2	1	140	911.1202	1/2" Extensions, 125 mm	1
89	917.1409	1/4" Hexagonal socket, 9 mm	1	116	911.1403	1/4" Bit socket, PZ3	1	141	911.1203	1/2" Extensions, 250 mm	1
90	917.1410	1/4" Hexagonal socket, 10 mm	1	117	911.1448	1/4" Bit socket Torx, T8	1	142	911.3803	3/8" Extensions 250 mm	1
91	917.1411	1/4" Hexagonal socket, 11 mm	1	118	911.1442	1/4" Bit socket Torx, T10	1	143	911.3802	3/8" Extensions 150 mm	1
92	917.1412	1/4" Hexagonal socket, 12 mm	1	119	911.1443	1/4" Bit socket Torx, T15	1	144	911.1423	1/4" Extension with hexagon drive, 50 mm	1
93	917.1413	1/4" Hexagonal socket, 13 mm	1	120	911.1444	1/4" Bit socket Torx, T20	1	145	911.3801	3/8" Extensions 75 mm	1
94	911.1415	1/4" Bit socket, PH1	1	121	911.1445	1/4" Bit socket Torx, T25	1	146	911.1424	1/4" Extension with hexagon drive, 100 mm	1
95	911.1416	1/4" Bit socket, PH2	1	122	911.1449	1/4" Bit socket Torx, T27	1	147	914.3810	3/8" HandReversible ratchet	1
96	911.1418	1/4" Bit socket slot, 4 mm	1	123	911.1446	1/4" Bit socket Torx, T30	1	148	911.1450	1/4" Universal joint	1
97	911.1419	1/4" Bit socket slot, 5,5 mm	1	124	911.1447	1/4" Bit socket Torx, T40	1	149	911.3850	3/8" Universal joint	1
98	917.1421	1/4" Bit socket slot, 6,5 mm	1	125	515.0992	SlimPOWER 1/2"Alloy rim impact socket, 17 mm	1	150	911.1250	1/2" Universal joint	1
99	911.1436	1/4" Bit socket hexagon, 3 mm	1	126	515.0993	SlimPOWER 1/2"Alloy rim impact socket, 19 mm	1	151	911.1207	3/8" Sliding adaptor, 3/8"Fx1/2"M	1
100	911.1437	1/4" Bit socket hexagon, 4 mm	1	127	515.0994	SlimPOWER 1/2"Alloy rim impact socket, 21 mm	1	152	911.1434	1/4" Square drive screwdriver, 150 mm	1
101	911.1438	1/4" Bit socket hexagon, 5 mm	1	128	911.3804	3/8" Spark plug socket, 16 mm	1	153	920.1490	1/4" SlimPOWER Reversible ratchet, 72 teeth	1
102	911.1439	1/4" Bit socket hexagon, 6 mm	1	129	911.3823	3/8" Spark plug socket, 18 mm	1	154	920.3890	3/8" SlimPOWER Reversible ratchet, 72 teeth	1
103	911.1440	1/4" Bit socket hexagon, 7 mm	1	130	911.3805	3/8" Spark plug socket, 21 mm	1	155	920.1290	1/2" SlimPOWER Reversible ratchet, 72 teeth	1
104	911.1441	1/4" Bit socket hexagon, 8 mm	1					156	917.1455	1/2" Flexi head drive handle	1
105	917.1452	1/4" Bit socket hexagon, 10 mm	1								

813.0057

## L Screw spanner set



755 x 398



P25



Pos.	Code	Description	pcs	Pos.	Code	Description	pcs	Pos.	Code	Description	pcs
1	517.0606	Combination spanners, offset, 6 mm	1	13	517.0618	Combination spanners, offset, 18 mm	1	25	517.0630	Combination spanners, offset, 30 mm	1
2	517.0607	Combination spanners, offset, 7 mm	1	14	517.0619	Combination spanners, offset, 19 mm	1	26	517.0632	Combination spanners, offset, 32 mm	1
3	517.0608	Combination spanners, offset, 8 mm	1	15	517.0620	Combination spanners, offset, 20 mm	1	27	503.4608	GEARplus reversing combination ratcheting spanner, 8 mm	1
4	517.0609	Combination spanners, offset, 9 mm	1	16	517.0621	Combination spanners, offset, 21 mm	1	28	503.4609	GEARplus reversing combination ratcheting spanner, 9 mm	1
5	517.0610	Combination spanners, offset, 10 mm	1	17	517.0622	Combination spanners, offset, 22 mm	1	29	503.4610	GEARplus reversing combination ratcheting spanner, 10 mm	1
6	517.0611	Combination spanners, offset, 11 mm	1	18	517.0623	Combination spanners, offset, 23 mm	1	30	503.4611	GEARplus reversing combination ratcheting spanner, 11 mm	1
7	517.0612	Combination spanners, offset, 12 mm	1	19	517.0624	Combination spanners, offset, 24 mm	1	31	503.4612	GEARplus reversing combination ratcheting spanner, 12 mm	1
8	517.0613	Combination spanners, offset, 13 mm	1	20	517.0625	Combination spanners, offset, 25 mm	1	32	503.4613	GEARplus reversing combination ratcheting spanner, 13 mm	1
9	517.0614	Combination spanners, offset, 14 mm	1	21	517.0626	Combination spanners, offset, 26 mm	1				
10	517.0615	Combination spanners, offset, 15 mm	1	22	517.0627	Combination spanners, offset, 27 mm	1				
11	517.0616	Combination spanners, offset, 16 mm	1	23	517.0628	Combination spanners, offset, 28 mm	1				
12	517.0617	Combination spanners, offset, 17 mm	1	24	517.0629	Combination spanners, offset, 29 mm	1				

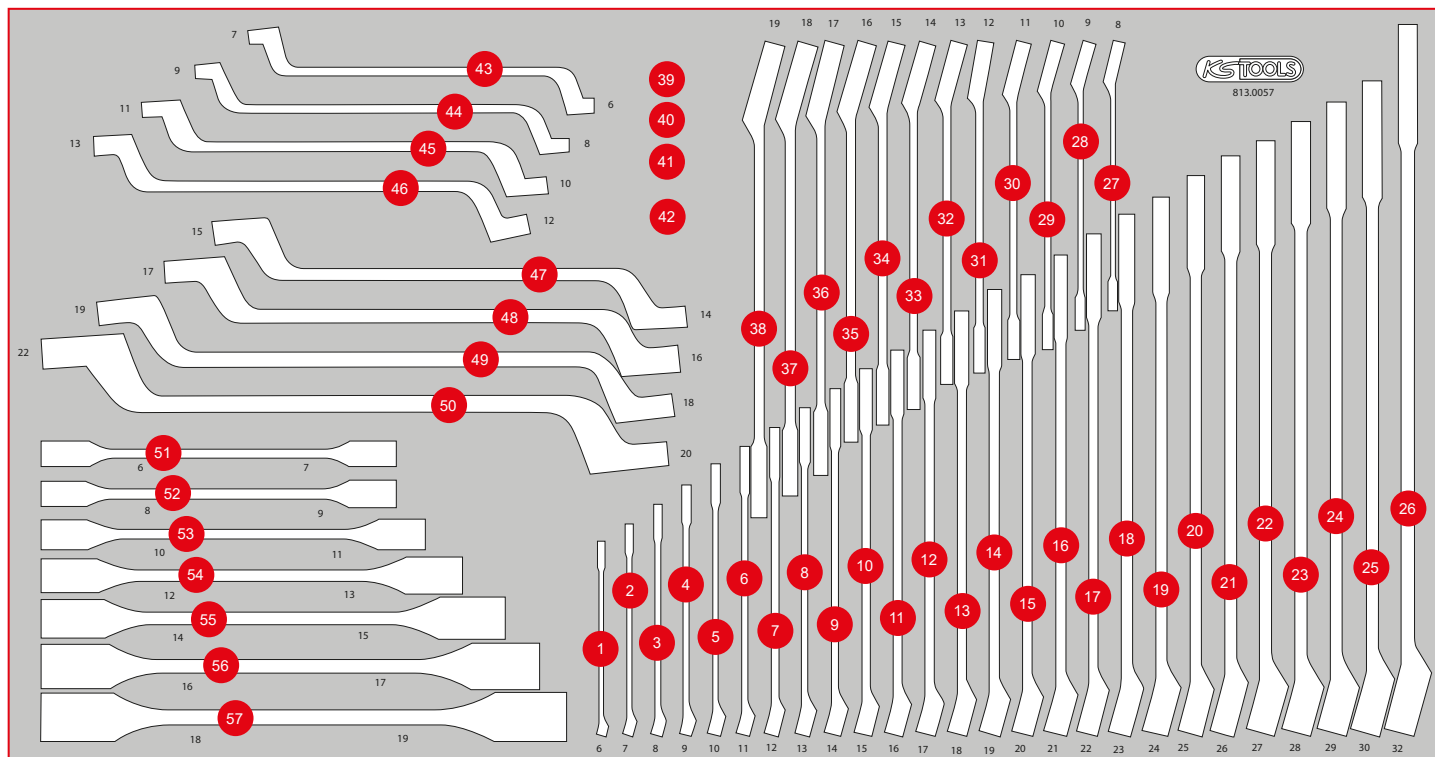

Pos.	Code	Description	pcs	Pos.	Code	Description	pcs	Pos.	Code	Description	pcs
33	503.4614	GEARplus reversing combination ratcheting spanner, 14 mm	1	41	503.4297	GEARplus socket adaptor, 3/8" x 13 mm	1	53	517.0302	Double revolving head spanner, 10 x 11 mm	1
34	503.4615	GEARplus reversing combination ratcheting spanner, 15 mm	1	42	503.4298	GEARplus socket adaptor, 1/2" x 19 mm	1	54	517.0303	Double revolving head spanner, 12 x 13 mm	1
35	503.4616	GEARplus reversing combination ratcheting spanner, 16 mm	1	43	517.0801	Double ring spanner, offset, 6 x 7 mm	1	55	517.0304	Double revolving head spanner, 14 x 15 mm	1
36	503.4617	GEARplus reversing combination ratcheting spanner, 17 mm	1	44	517.0802	Double ring spanner, offset, 8 x 9 mm	1	56	517.0305	Double revolving head spanner, 16 x 17 mm	1
37	503.4618	GEARplus reversing combination ratcheting spanner, 18 mm	1	45	517.0804	Double ring spanner, offset, 10 x 11 mm	1	57	517.0306	Double revolving head spanner, 18 x 19 mm	1
38	503.4619	GEARplus reversing combination ratcheting spanner, 19 mm	1	46	517.0807	Double ring spanner, offset, 12 x 13 mm	1				
39	503.4290	GEARplus bit adaptor, 1/4" x 10 mm	1	47	517.0809	Double ring spanner, offset, 14 x 15 mm	1				
40	503.4296	GEARplus socket adaptor, 1/4" x 10 mm	1	48	517.0810	Double ring spanner, offset, 16 x 17 mm	1				
				49	517.0812	Double ring spanner, offset, 18 x 19 mm	1				
				50	517.0813	Double ring spanner, offset, 20 x 22 mm	1				
				51	517.0300	Double revolving head spanner, 6 x 7 mm	1				
				52	517.0301	Double revolving head spanner, 8 x 9 mm	1				

813.0033

# L Screwdriver set



755 x 398

P25

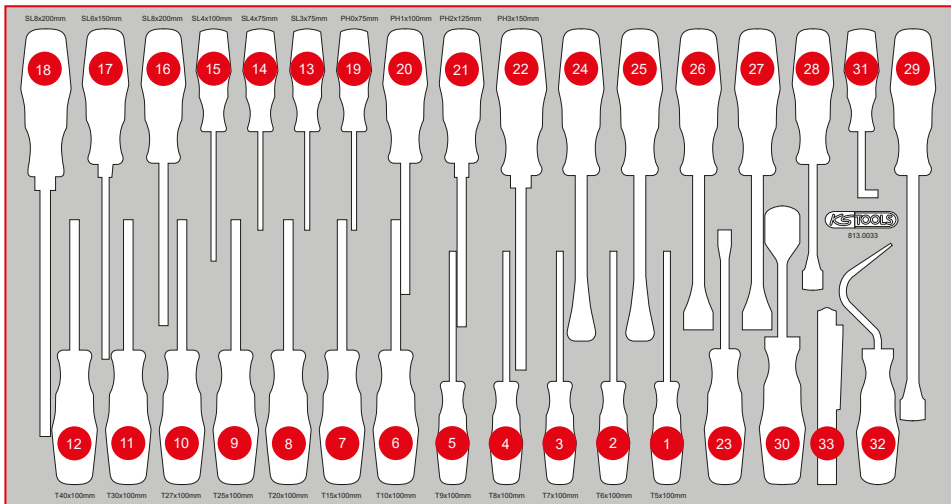
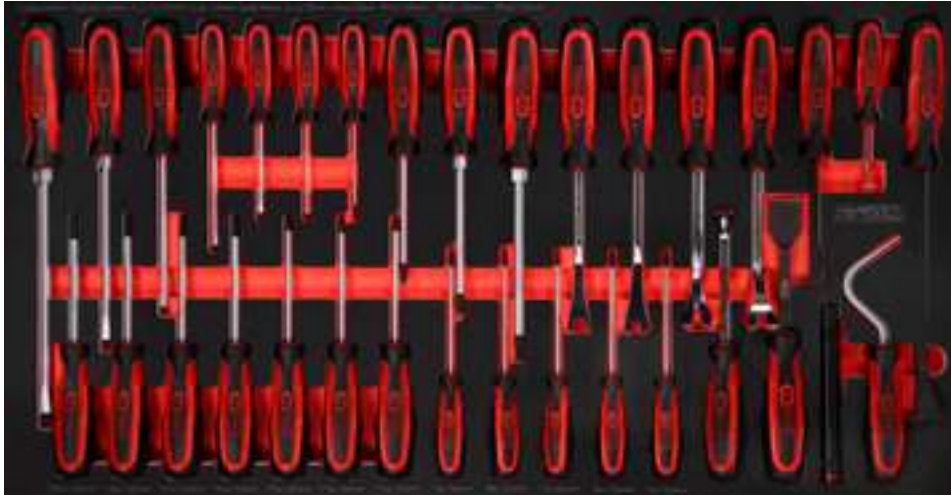

Pos.	Code	Description	pcs
1	159.1133	ERGOTORQUEplus screwdriver, Torx, T5	1
2	159.1134	ERGOTORQUEplus screwdriver, Torx, T6	1
3	159.1135	ERGOTORQUEplus screwdriver, Torx, T7	1
4	159.1030	ERGOTORQUEplus screwdriver, Torx, T8	1
5	159.1031	ERGOTORQUEplus screwdriver, Torx, T9	1
6	159.1032	ERGOTORQUEplus screwdriver, Torx, T10	1
7	159.1033	ERGOTORQUEplus screwdriver, Torx, T15	1
8	159.1034	ERGOTORQUEplus screwdriver, Torx, T20	1
9	159.1035	ERGOTORQUEplus screwdriver, Torx, T25	1
10	159.1036	ERGOTORQUEplus screwdriver, Torx, T27	1
11	159.1037	ERGOTORQUEplus screwdriver, Torx, T30	1
12	159.1038	ERGOTORQUEplus screwdriver, Torx, T40	1
13	159.1002	ERGOTORQUEplus screwdriver for slotted screws, 3 mm, 155 mm long	1
14	159.1003	ERGOTORQUEplus screwdriver for slotted screws, 4 mm, 155 mm long	1
15	159.1004	ERGOTORQUEplus screwdriver for slotted screws, 4 mm, 180 mm long	1
16	159.1006	ERGOTORQUEplus screwdriver for slotted screws, 5,5 mm, 230 mm long	1
17	159.1009	ERGOTORQUEplus screwdriver for slotted screws, 6,5 mm, 255 mm long	1
18	159.1011	ERGOTORQUEplus screwdriver for slotted screws, 8 mm, 315 mm long	1
19	159.1027	ERGOTORQUEplus screwdriver, Torx, PH0, 155 mm	1
20	159.1029	ERGOTORQUEplus screwdriver, Torx, PH1, 205 mm	1
21	159.1022	ERGOTORQUEplus screwdriver, Torx, PH2, 230 mm	1
22	159.1024	ERGOTORQUEplus screwdriver, Torx, PH3, 265 mm	1
23	140.2617	Clip remover short, length 240 mm, opening 5 mm	1
24	140.2373	Clip remover short, length 245 mm, opening 10 mm	1
25	140.2371	Clip remover short, length 245 mm, opening 4 mm	1
26	140.2616	Clip remover, short 7,5 mm	1
27	140.2615	Clip remover, short 9 mm	1
28	911.8101	Pry bar, 11 x 115 mm	1
29	911.8102	Pry bar, 15 x 185 mm	1
30	907.2232	Gasket scraper, 25 x 200 mm	1
31	550.1048	Hook, 90° offset	1
32	550.1073	Hook, large, sickle	1
33	150.4370	perfectLight torch 85 lumen	1





**873.7014-R101P...R200P**  
Replacement key for lock number xyz



**873.7014-R201P...R300P**  
Lock with 2 keys, lock number xyz



**873.3008-R008P**  
Full extension (with ball-bearing guide) with automatic retraction, right



**873.3008-R009P**  
Full extension with self-closing, for drawer, left



**873.5008-R009P**  
Fixed castors, incl. screws



**873.5008-R011P**  
Swivel castors with brakes, incl. screws

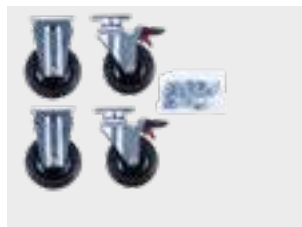

**873.5008-R014P**  
Roller set, incl. screws



**873.3008-R007P**  
Stainless steel work surface



**873.3008-R006P**  
Storage for work surface, including screw cover, usable on both sides



**873.3008-R005P**  
Compartment with website and ball-bearing guide, 755x398x65 mm



**873.3008-R004P**  
Compartment with ball-bearing guide, 755x398x65 mm



**873.3008-R003P**  
Compartment with logo and ball-bearing guide, 755x398x145 mm



**873.5008-R002P**  
Can holder including screws, W = 310 mm



**873.3008-R002P**  
Paper roll holder including screws, W= 320 mm



**873.4008-R005P**  
Plastic bumpers, front left, back right



**873.4008-R002P**  
Plastic bumpers, front right, back left



**873.7014-R004P**  
M8 screws (16 pcs.)



**873.7014-R003P**  
M6x12 screw (1 pcs.)



**873.3008-R001P**  
Body of workshop trolley attachment



Enough spares for  
your treasure!