

# P25

**workshop tool trolley**  
with 446 tools for 6 drawers  
**825.6446**

# PRECIOUS WIDTH

P25



**Workshop trolley P25**  
with 8 compartments  
873.3008



**DUO Lock** Brilliant locking system



**8 Drawers** each load capacity up to 50 kg

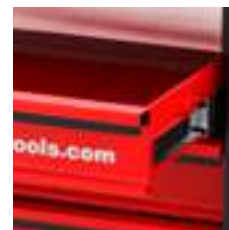

Stable **ball bearing**



**Stainless steel surface**



**Lock** lockable



**Anti-static castors** with brakes



Integrated **corner protection**



**Paper roll holder** included



**Can holder** included

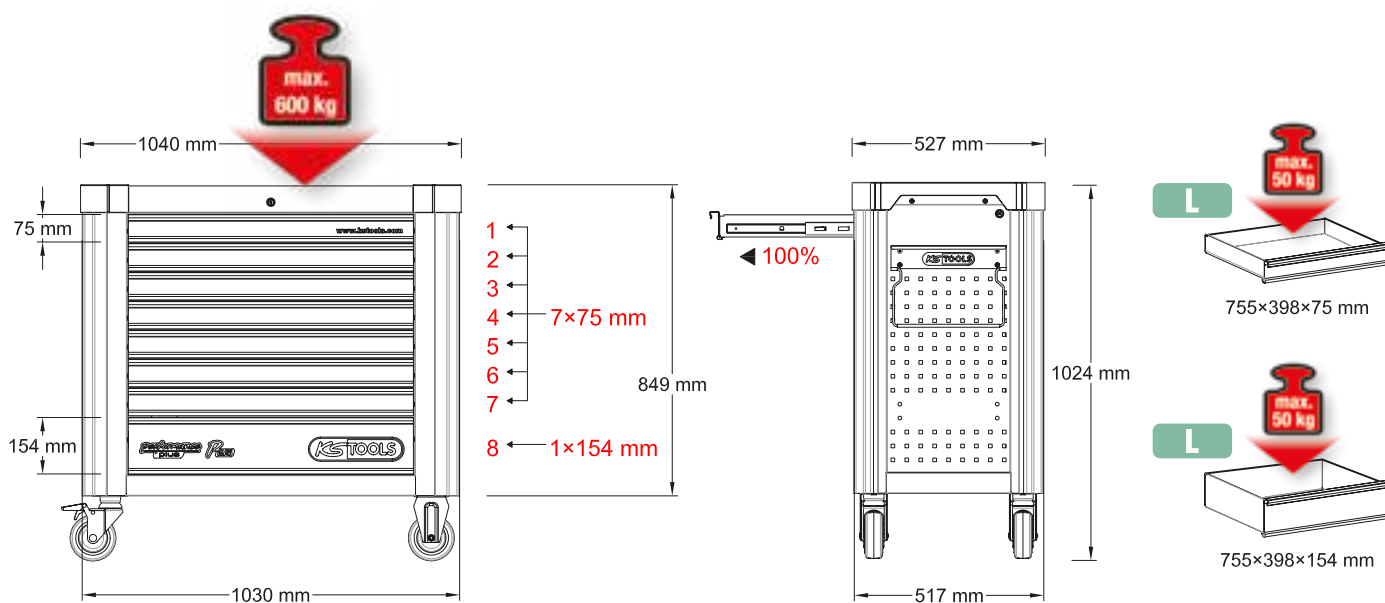

# P25 workshop tool trolley set with 446 tools for 6 drawers

825.6446



Screwdriver set in foam insert

813.1033

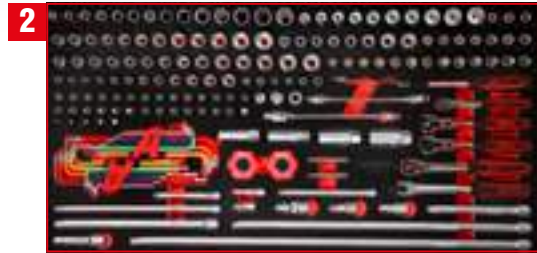

1/4" + 3/8" socket spanner set in foam insert

813.0183



1/2" socket spanner set in foam insert

813.0117



Screw spanner set in foam insert

813.0053



T-handle angle wrench and screwdriver set in foam insert

813.0024

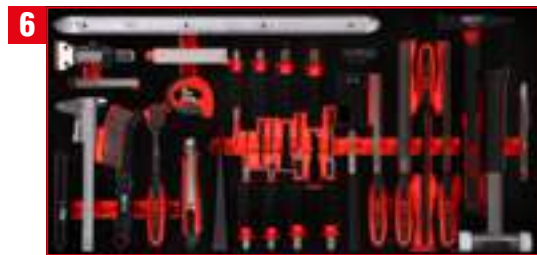

Hammer, chisel and measuring tool set in foam insert

813.1036

813.1033

**L** Screwdriver set

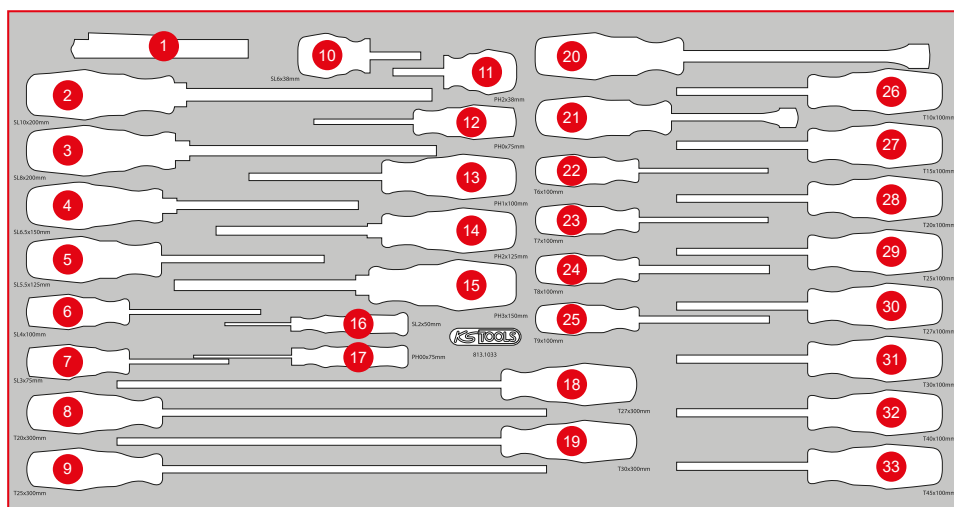

Pos.	Code	Description	pcs
1	150.4370	perfectLight torch 85 lumen	1
2	159.1012	ERGOTORQUEplus screwdriver for slotted screws, 10 mm, 315 mm long	1
3	159.1011	ERGOTORQUEplus screwdriver for slotted screws, 8 mm, 315 mm long	1
4	159.1009	ERGOTORQUEplus screwdriver for slotted screws, 6,5 mm, 255 mm long	1
5	159.1006	ERGOTORQUEplus screwdriver for slotted screws, 5,5 mm, 230 mm long	1
6	159.1004	ERGOTORQUEplus screwdriver for slotted screws, 4 mm, 180 mm long	1
7	159.1002	ERGOTORQUEplus screwdriver for slotted screws, 3 mm, 155 mm long	1
8	159.1261	ERGOTORQUEplus screwdriver, Torx, T20, long	1
9	159.1262	ERGOTORQUEplus screwdriver, Torx, T25, long	1
10	159.1001	ERGOTORQUEplus screwdriver for slotted screws, short, 6 mm	1
11	159.1026	ERGOTORQUEplus screwdriver, Torx, short, PH2	1
12	159.1027	ERGOTORQUEplus screwdriver, Torx, PH0, 155 mm	1
13	159.1029	ERGOTORQUEplus screwdriver, Torx, PH1, 205 mm	1
14	159.1022	ERGOTORQUEplus screwdriver, Torx, PH2, 230 mm	1
15	159.1024	ERGOTORQUEplus screwdriver, Torx, PH3, 265 mm	1
16	500.7109	Precision screwdriver, slot, 2 mm	1
17	500.7831	Precision screwdriver, PHILLIPS, PH00 x 2,0 mm	1
18	159.1263	ERGOTORQUEplus screwdriver, Torx, T27, long	1
19	159.1264	ERGOTORQUEplus screwdriver, Torx, T30, long	1
20	911.8102	Pry bar, 15 x 185 mm	1
21	911.8101	Pry bar, 11 x 115 mm	1
22	159.1134	ERGOTORQUEplus screwdriver, Torx, T6	1
23	159.1135	ERGOTORQUEplus screwdriver, Torx, T7	1
24	159.1030	ERGOTORQUEplus screwdriver, Torx, T8	1
25	159.1031	ERGOTORQUEplus screwdriver, Torx, T9	1
26	159.1032	ERGOTORQUEplus screwdriver, Torx, T10	1
27	159.1033	ERGOTORQUEplus screwdriver, Torx, T15	1
28	159.1034	ERGOTORQUEplus screwdriver, Torx, T20	1
29	159.1035	ERGOTORQUEplus screwdriver, Torx, T25	1
30	159.1036	ERGOTORQUEplus screwdriver, Torx, T27	1
31	159.1037	ERGOTORQUEplus screwdriver, Torx, T30	1
32	159.1038	ERGOTORQUEplus screwdriver, Torx, T40	1
33	159.1136	ERGOTORQUEplus screwdriver, Torx, T45	1

813.0183

**L** 1/4" + 3/8" Socket spanner set



Pos.	Code	Description	pcs	Pos.	Code	Description	pcs	Pos.	Code	Description	pcs
1	917.4831	3/8" 12 Point socket, deep, 6 mm	1	31	911.3984	3/8" 12 Point socket, 11 mm	1	61	917.3812	3/8" Hexagonal socket, 12 mm	1
2	917.4832	3/8" 12 Point socket, deep, 7 mm	1	32	911.3985	3/8" 12 Point socket, 12 mm	1	62	917.3813	3/8" Hexagonal socket, 13 mm	1
3	917.3855	3/8" 12 Point socket, deep, 8 mm	1	33	911.3986	3/8" 12 Point socket, 13 mm	1	63	917.3814	3/8" Hexagonal socket, 14 mm	1
4	917.3856	3/8" 12 Point socket, deep, 9 mm	1	34	911.3987	3/8" 12 Point socket, 14 mm	1	64	917.3815	3/8" Hexagonal socket, 15 mm	1
5	917.3970	3/8" 12 Point socket, deep, 10 mm	1	35	911.3988	3/8" 12 Point socket, 15 mm	1	65	917.3816	3/8" Hexagonal socket, 16 mm	1
6	917.3971	3/8" 12 Point socket, deep, 11 mm	1	36	911.3989	3/8" 12 Point socket, 16 mm	1	66	917.3817	3/8" Hexagonal socket, 17 mm	1
7	917.3972	3/8" 12 Point socket, deep, 12 mm	1	37	911.3992	3/8" 12 Point socket, 17 mm	1	67	917.3818	3/8" Hexagonal socket, 18 mm	1
8	917.3973	3/8" 12 Point socket, deep, 13 mm	1	38	911.3994	3/8" 12 Point socket, 19 mm	1	68	917.3819	3/8" Hexagonal socket, 19 mm	1
9	917.3974	3/8" 12 Point socket, deep, 14 mm	1	39	911.3996	3/8" 12 Point socket, 21 mm	1	69	911.3865	3/8" Bit socket hexagon, 5 mm	1
10	917.3975	3/8" 12 Point socket, deep, 15 mm	1	40	911.4342	3/8" Torx E Socket, E8	1	70	911.38655	3/8" Bit socket hexagon, 5,5 mm	1
11	917.3976	3/8" 12 Point socket, deep, 16 mm	1	41	911.4318	3/8" Torx E Socket, E10	1	71	911.3866	3/8" Bit socket hexagon, 6 mm	1
12	917.3977	3/8" 12 Point socket, deep, 17 mm	1	42	911.4319	3/8" Torx E Socket, E11	1	72	911.3867	3/8" Bit socket hexagon, 7 mm	1
13	917.3978	3/8" 12 Point socket, deep, 18 mm	1	43	911.4320	3/8" Torx E Socket, E12	1	73	911.3868	3/8" Bit socket hexagon, 8 mm	1
14	917.3979	3/8" 12 Point socket, deep, 19 mm	1	44	911.4321	3/8" Torx E Socket, E14	1	74	917.3969	3/8" Bit socket hexagon, 9 mm	1
15	917.4851	3/8" 12-edge socket with joint, 10 mm	1	45	911.4343	3/8" Torx E Socket, E16	1	75	917.3857	3/8" Bit socket hexagon, 10 mm	1
16	917.4852	3/8" 12-edge socket with joint, 11 mm	1	46	911.4344	3/8" Torx E Socket, E18	1	76	911.3862	3/8" Bit socket hexagon, 12 mm	1
17	917.4853	3/8" 12-edge socket with joint, 12 mm	1	47	911.4345	3/8" Torx E Socket, E20	1	77	911.3884	3/8" Bit socket Torx, T50	1
18	917.4854	3/8" 12-edge socket with joint, 13 mm	1	48	911.3871	3/8" Bit socket Torx, T25	1	78	911.3888	3/8" Bit socket Torx, T55	1
19	917.4855	3/8" 12-edge socket with joint, 14 mm	1	49	911.3872	3/8" Bit socket Torx, T27	1	79	911.3889	3/8" Bit socket Torx, T60	1
20	917.4856	3/8" 12-edge socket with joint, 15 mm	1	50	911.3873	3/8" Bit socket Torx, T30	1	80	911.3920	3/8" Bit socket spline (XZN), M10	1
21	917.4857	3/8" 12-edge socket with joint, 16 mm	1	51	911.3874	3/8" Bit socket Torx, T40	1	81	917.3903	3/8" Bit socket spline (XZN), M12	1
22	917.4858	3/8" 12-edge socket with joint, 17 mm	1	52	911.3885	3/8" Bit socket Torx, T45	1	82	917.1404	1/4" Hexagonal socket, 4 mm	1
23	917.4859	3/8" 12-edge socket with joint, 18 mm	1	53	911.3917	3/8" Bit socket spline (XZN), M8	1	83	917.1405	1/4" Hexagonal socket, 5 mm	1
24	917.4861	3/8" 12-edge socket with joint, 19 mm	1	54	917.3901	3/8" Bit socket spline (XZN), M9	1	84	917.14055	1/4" Hexagonal socket, 5,5 mm	1
25	911.3918	3/8" Bit socket spline (XZN), M4	1	55	917.3806	3/8" Hexagonal socket, 6 mm	1	85	917.1406	1/4" Hexagonal socket, 6 mm	1
26	911.3915	3/8" Bit socket spline (XZN), M5	1	56	917.3807	3/8" Hexagonal socket, 7 mm	1	86	917.1407	1/4" Hexagonal socket, 7 mm	1
27	911.3916	3/8" Bit socket spline (XZN), M6	1	57	917.3808	3/8" Hexagonal socket, 8 mm	1	87	917.1408	1/4" Hexagonal socket, 8 mm	1
28	911.3981	3/8" 12 Point socket, 8 mm	1	58	917.3809	3/8" Hexagonal socket, 9 mm	1	88	917.1409	1/4" Hexagonal socket, 9 mm	1
29	911.3982	3/8" 12 Point socket, 9 mm	1	59	917.3810	3/8" Hexagonal socket, 10 mm	1	89	917.1410	1/4" Hexagonal socket, 10 mm	1
30	911.3983	3/8" 12 Point socket, 10 mm	1	60	917.3811	3/8" Hexagonal socket, 11 mm	1	90	917.1411	1/4" Hexagonal socket, 11 mm	1

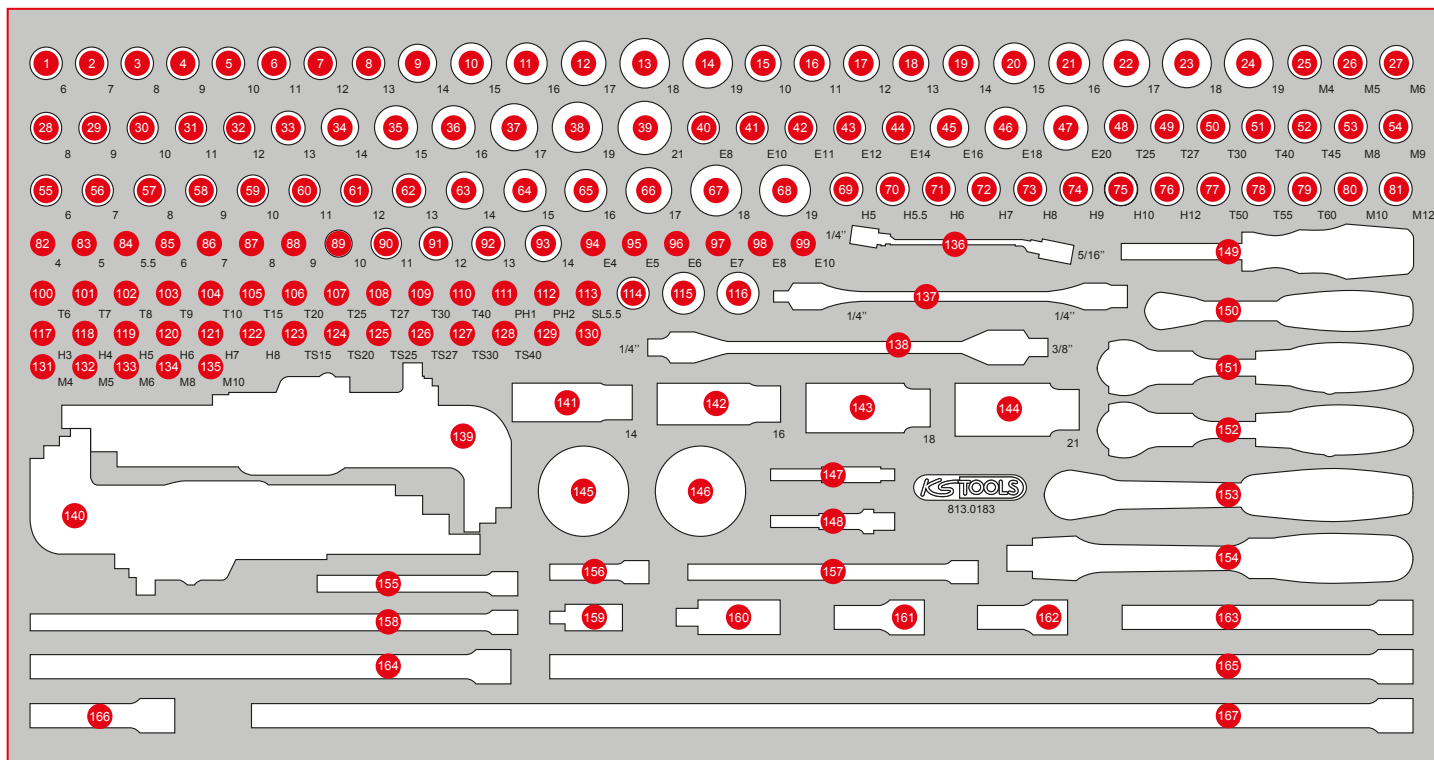

Pos.	Code	Description	pcs	Pos.	Code	Description	pcs	Pos.	Code	Description	pcs
91	917.1412	1/4" Hexagonal socket, 12 mm	1	121	911.1440	1/4" Bit socket hexagon, 7 mm	1	148	514.1107	Socket adaptor, 1/4"x3/8"	1
92	917.1413	1/4" Hexagonal socket, 13 mm	1	122	911.1441	1/4" Bit socket hexagon, 8 mm	1	149	911.1434	1/4" Square drive screwdriver, 150 mm	1
93	917.1414	1/4" Hexagonal socket, 14 mm	1	123	911.1702	1/4" Bit socket five star tamperproof, TS15	1	150	920.1490	1/4" SlimPOWER Reversible ratchet, 72 teeth	1
94	911.4313	1/4" Torx E Socket, E4	1	124	911.1703	1/4" Bit socket five star tamperproof, TS20	1	151	914.1405	1/4" MODIFIX mini T-handle swivel head ratchet, 72 teeth	1
95	911.4314	1/4" Torx E Socket, E5	1	125	911.1704	1/4" Bit socket five star tamperproof, TS25	1	152	914.3815	3/8" MODIFIX mini T-handle swivel head ratchet, 72 teeth, 0°+90°	1
96	911.4315	1/4" Torx E Socket, E6	1	126	911.1705	1/4" Bit socket five star tamperproof, TS27	1	153	920.3890	3/8" SlimPOWER Reversible ratchet, 72 teeth	1
97	911.4316	1/4" Torx E Socket, E7	1	127	911.1706	1/4" Bit socket five star tamperproof, TS30	1	154	917.3939	3/8" Flexi head drive handle	1
98	911.4317	1/4" Torx E Socket, E8	1	128	911.1707	1/4" Bit socket five star tamperproof, TS40	1	155	911.1424	1/4" Extension with hexagon drive, 100 mm	1
99	911.4332	1/4" Torx E Socket, E10	1	129	911.0101	1/4" socket with magnet	1	156	911.1423	1/4" Extension with hexagon drive, 50 mm	1
100	911.4407	1/4" Bit socket Torx, T6	1	130	911.1494	Adaptor, 1/4" Mx3/8" F	1	157	911.1451	1/4" Extension with hexagon drive, 150 mm	1
101	911.4362	1/4" Bit socket Torx, T7	1	131	911.2341	1/4" Bit spline XZN, 25 mm, M4	1	158	911.1543	1/4" Wobble extension with hexagon drive, 250 mm	1
102	911.1448	1/4" Bit socket Torx, T8	1	132	911.2344	1/4" Bit spline XZN, 25 mm, M5	1	159	911.1450	1/4" Universal joint	1
103	911.1478	1/4" Bit socket Torx, T9	1	133	911.2347	1/4" Bit spline XZN, 25 mm, M6	1	160	911.3850	3/8" Universal joint	1
104	911.1442	1/4" Bit socket Torx, T10	1	134	911.2350	1/4" Bit spline XZN, 25 mm, M8	1	161	911.3852	3/8" Extension with knurling, 45 mm	1
105	911.1443	1/4" Bit socket Torx, T15	1	135	911.2353	1/4" Bit spline XZN, 25 mm, M10	1	162	911.3910	Wobble extension, 3/8", 45 mm	1
106	911.1444	1/4" Bit socket Torx, T20	1	136	503.4679	GEARplus mini reversible ratcheting spanner, 1/4"x5/16"	1	163	911.3912	Wobble extension, 3/8", 150 mm	1
107	911.1445	1/4" Bit socket Torx, T25	1	137	517.0314	Double-joint spanner 1/4" Bits and sockets	1	164	911.3914	Wobble extension, 3/8", 250 mm	1
108	911.1449	1/4" Bit socket Torx, T27	1	138	517.0338	Double-joint-spanner for 1/4" and 3/8" sockets	1	165	911.0045	Wobble extension, 3/8", 450 mm	1
109	911.1446	1/4" Bit socket Torx, T30	1	139	151.4530	Ball ended Torx key wrench set, extra long and bent 108°, 9 pcs	9	166	911.3911	Wobble extension, 3/8", 75 mm	1
110	911.1447	1/4" Bit socket Torx, T40	1	140	151.4420	Ball ended hexagon key wrench set, extra long, 9 pcs	9	167	911.4892	3/8" Extensions 600 mm	1
111	911.1415	1/4" Bit socket, PH1	1	141	911.3990	3/8" Special spark plug socket, thin-walled 14 mm	1				
112	911.1416	1/4" Bit socket, PH2	1	142	911.3804	3/8" Spark plug socket, 16 mm	1				
113	911.1419	1/4" Bit socket slot, 5,5 mm	1	143	911.3823	3/8" Spark plug socket, 18 mm	1				
114	911.3897	3/8" Reducing adaptor, 3/8" F x 1/4" M	1	144	911.3805	3/8" Spark plug socket, 21 mm	1				
115	911.1233	Reducing adaptor, 1/2" F x 3/8" M	1	145	914.1410	Mini hand reversible ratchet, 1/4", 72 teeth	1				
116	911.4351	1/2" Bit adaptor socket, 1/2" x 5/16", 38 mm	1	146	914.3810	Mini hand reversible ratchet, 3/8", 72 teeth	1				
117	911.1436	1/4" Bit socket hexagon, 3 mm	1	147	514.1106	Socket adaptor, 1/4"x1/4"	1				
118	911.1437	1/4" Bit socket hexagon, 4 mm	1								
119	911.1438	1/4" Bit socket hexagon, 5 mm	1								
120	911.1439	1/4" Bit socket hexagon, 6 mm	1								

813.0117

# L 1/2" Socket spanner set



Pos.	Code	Description	pcs	Pos.	Code	Description	pcs	Pos.	Code	Description	pcs
1	920.1290	1/2" SlimPOWER Reversible ratchet, 72 teeth	1	21	917.1249	1/2" Hexagonal socket, deep, 19 mm	1	41	515.1030	1/2" Hexagon impact socket short, 30 mm	1
2	914.1225	Twister-ratchet-handle, 1/2", 60 teeth	1	22	917.1259	1/2" Hexagonal socket, deep, 21 mm	1	42	917.1210	1/2" Hexagonal socket, 10 mm	1
3	917.1425	1/2" Flexi head drive handle, 370 mm	1	23	515.1010	1/2" Hexagon impact socket short, 10 mm	1	43	917.1211	1/2" Hexagonal socket, 11 mm	1
4	911.1836	Wobble extension, 1/2", 500 mm	1	24	515.1011	1/2" Hexagon impact socket short, 11 mm	1	44	917.1212	1/2" Hexagonal socket, 12 mm	1
5	911.1202	1/2" Extensions, 125 mm	1	25	515.1012	1/2" Hexagon impact socket short, 12 mm	1	45	917.1213	1/2" Hexagonal socket, 13 mm	1
6	911.1203	1/2" Extensions, 250 mm	1	26	515.1013	1/2" Hexagon impact socket short, 13 mm	1	46	917.1214	1/2" Hexagonal socket, 14 mm	1
7	515.1176	1/2" impact socket, XZN, M18 long	1	27	515.1014	1/2" Hexagon impact socket short, 14 mm	1	47	917.1215	1/2" Hexagonal socket, 15 mm	1
8	911.1250	1/2" Universal joint	1	28	515.1015	1/2" Hexagon impact socket short, 15 mm	1	48	917.1216	1/2" Hexagonal socket, 16 mm	1
9	911.1381	Wobble extension, 1/2", 50 mm	1	29	515.1016	1/2" Hexagon impact socket short, 16 mm	1	49	917.1217	1/2" Hexagonal socket, 17 mm	1
10	150.1705	Special drive shaft impact socket, 1/2", 30 mm	1	30	515.1017	1/2" Hexagon impact socket short, 17 mm	1	50	917.1218	1/2" Hexagonal socket, 18 mm	1
11	150.1704	Special drive shaft impact socket, 1/2", 34 mm	1	31	515.1018	1/2" Hexagon impact socket short, 18 mm	1	51	917.1219	1/2" Hexagonal socket, 19 mm	1
12	150.1707	Special drive shaft impact socket, 1/2", 36 mm	1	32	515.1019	1/2" Hexagon impact socket short, 19 mm	1	52	917.1220	1/2" Hexagonal socket, 20 mm	1
13	515.0991	SlimPOWER 1/2"Alloy rim impact socket, 15 mm	1	33	515.1020	1/2" Hexagon impact socket short, 20 mm	1	53	917.1221	1/2" Hexagonal socket, 21 mm	1
14	515.0992	SlimPOWER 1/2"Alloy rim impact socket, 17 mm	1	34	515.1021	1/2" Hexagon impact socket short, 21 mm	1	54	917.1222	1/2" Hexagonal socket, 22 mm	1
15	515.0993	SlimPOWER 1/2"Alloy rim impact socket, 19 mm	1	35	515.1022	1/2" Hexagon impact socket short, 22 mm	1	55	917.1223	1/2" Hexagonal socket, 23 mm	1
16	515.0994	SlimPOWER 1/2"Alloy rim impact socket, 21 mm	1	36	515.1024	1/2" Hexagon impact socket short, 24 mm	1	56	917.1224	1/2" Hexagonal socket, 24 mm	1
17	515.0995	SlimPOWER 1/2"Alloy rim impact socket, 22 mm	1	37	515.1025	1/2" Hexagon impact socket short, 25 mm	1	57	917.1342	1/2" Hexagonal socket, 25 mm	1
18	917.1240	1/2" Hexagonal socket, deep, 10 mm	1	38	515.1027	1/2" Hexagon impact socket short, 27 mm	1	58	917.1343	1/2" Hexagonal socket, 26 mm	1
19	917.1243	1/2" Hexagonal socket, deep, 13 mm	1	39	515.1028	1/2" Hexagon impact socket short, 28 mm	1	59	917.1227	1/2" Hexagonal socket, 27 mm	1
20	917.1247	1/2" Hexagonal socket, deep, 17 mm	1	40	515.1029	1/2" Hexagon impact socket short, 29 mm	1	60	917.1344	1/2" Hexagonal socket, 28 mm	1

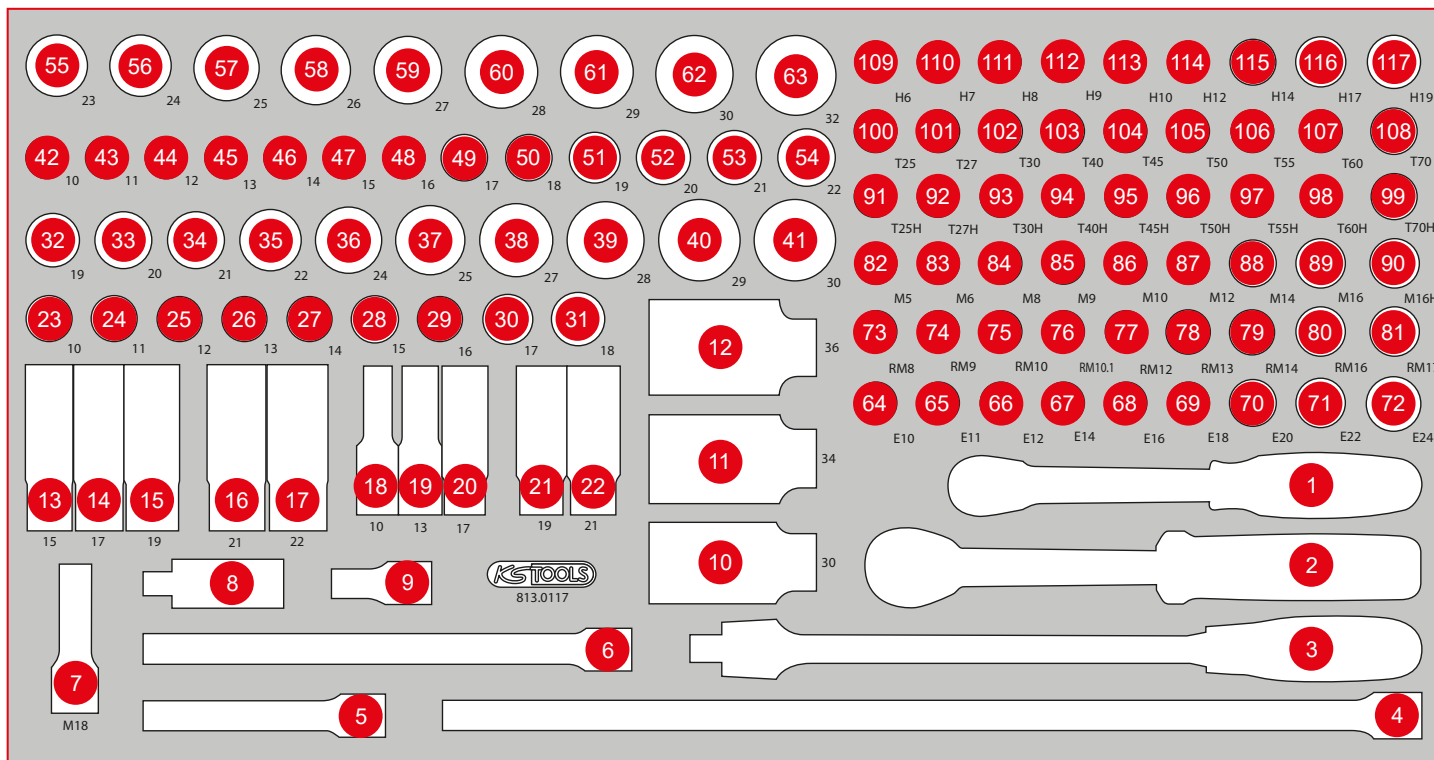

Pos.	Code	Description	pcs	Pos.	Code	Description	pcs	Pos.	Code	Description	pcs
61	917.1345	1/2" Hexagonal socket, 29 mm	1	81	911.5306	1/2" Bit socket spline (XZN), M17, 55 mm	1	100	911.1362	1/2" Bit socket Torx, T25	1
62	917.1230	1/2" Hexagonal socket, 30 mm	1	82	911.1340	1/2" Bit socket spline (XZN), M5, 55 mm	1	101	911.1363	1/2" Bit socket Torx, T27	1
63	917.1232	1/2" Hexagonal socket, 32 mm	1	83	911.1341	1/2" Bit socket spline (XZN), M6, 55 mm	1	102	911.1364	1/2" Bit socket Torx, T30	1
64	911.4333	1/2" Torx E Socket, E10	1	84	911.1342	1/2" Bit socket spline (XZN), M8, 55 mm	1	103	911.1365	1/2" Bit socket Torx, T40	1
65	911.4334	1/2" Torx E Socket, E11	1	85	911.1313	1/2" Bit socket spline (XZN), M9, 55 mm	1	104	911.1366	1/2" Bit socket Torx, T45	1
66	911.4335	1/2" Torx E Socket, E12	1	86	911.1343	1/2" Bit socket spline (XZN), M10, 55 mm	1	105	911.1367	1/2" Bit socket Torx, T50	1
67	911.4336	1/2" Torx E Socket, E14	1	87	911.1344	1/2" Bit socket spline (XZN), M12, 55 mm	1	106	911.1368	1/2" Bit socket Torx, T55	1
68	911.4322	1/2" Torx E Socket, E16	1	88	911.1345	1/2" Bit socket spline (XZN), M14, 55 mm	1	107	911.1369	1/2" Bit socket Torx, T60	1
69	911.4323	1/2" Torx E Socket, E18	1	89	911.1346	1/2" Bit socket spline (XZN), M16, 55 mm	1	108	911.1370	1/2" Bit socket Torx, T70	1
70	911.4324	1/2" Torx E Socket, E20	1	90	911.1348	1/2" Bit socket spline (XZN) tamperproof, M16, 55 mm	1	109	911.1306	1/2" Bit socket hexagon, short, 6 mm	1
71	911.4325	1/2" Torx E Socket, E22	1	91	911.1372	1/2" Bit socket Torx tamperproof, TB25	1	110	911.1307	1/2" Bit socket hexagon, short, 7 mm	1
72	911.4326	1/2" Torx E Socket, E24	1	92	911.1373	1/2" Bit socket Torx tamperproof, TB27	1	111	911.1308	1/2" Bit socket hexagon, short, 8 mm	1
73	911.4514	Bit socket for RIBE screws, M8, length 55 mm	1	93	911.1374	1/2" Bit socket Torx tamperproof, TB30	1	112	911.1309	1/2" Bit socket hexagon, short, 9 mm	1
74	911.4515	Bit socket for RIBE screws, M9, length 55 mm	1	94	911.1375	1/2" Bit socket Torx tamperproof, TB40	1	113	911.1310	1/2" Bit socket hexagon, short, 10 mm	1
75	911.4516	Bit socket for RIBE screws, M10, length 55 mm	1	95	911.1376	1/2" Bit socket Torx tamperproof, TB45	1	114	911.1312	1/2" Bit socket hexagon, short, 12 mm	1
76	911.4551	Bit socket for RIBE screws, M10.1, length 55 mm	1	96	911.1377	1/2" Bit socket Torx tamperproof, TB50	1	115	911.1314	1/2" Bit socket hexagon, short, 14 mm	1
77	911.4517	Bit socket for RIBE screws, M12, length 55 mm	1	97	911.1378	1/2" Bit socket Torx tamperproof, TB55	1	116	911.1317	1/2" Bit socket hexagon, short, 17 mm	1
78	911.4518	Bit socket for RIBE screws, M13, length 55 mm	1	98	911.1379	1/2" Bit socket Torx tamperproof, TB60	1	117	911.1319	1/2" Bit socket hexagon, short, 19 mm	1
79	911.4519	Bit socket for RIBE screws, M14, length 55 mm	1	99	911.1380	1/2" Bit socket Torx tamperproof, TB70	1				
80	911.4552	Bit socket for RIBE screws, M16, length 55 mm	1								

813.0053

**L** Screw spanner set



Pos.	Code	Description	pcs	Pos.	Code	Description	pcs	Pos.	Code	Description	pcs
1	517.0606	Combination spanners, offset, 6 mm	1	13	517.0618	Combination spanners, offset, 18 mm	1	25	517.0630	Combination spanners, offset, 30 mm	1
2	517.0607	Combination spanners, offset, 7 mm	1	14	517.0619	Combination spanners, offset, 19 mm	1	26	517.0632	Combination spanners, offset, 32 mm	1
3	517.0608	Combination spanners, offset, 8 mm	1	15	517.0620	Combination spanners, offset, 20 mm	1	27	503.4608	GEARplus reversing combination ratcheting spanner, 8 mm	1
4	517.0609	Combination spanners, offset, 9 mm	1	16	517.0621	Combination spanners, offset, 21 mm	1	28	503.4609	GEARplus reversing combination ratcheting spanner, 9 mm	1
5	517.0610	Combination spanners, offset, 10 mm	1	17	517.0622	Combination spanners, offset, 22 mm	1	29	503.4610	GEARplus reversing combination ratcheting spanner, 10 mm	1
6	517.0611	Combination spanners, offset, 11 mm	1	18	517.0623	Combination spanners, offset, 23 mm	1	30	503.4611	GEARplus reversing combination ratcheting spanner, 11 mm	1
7	517.0612	Combination spanners, offset, 12 mm	1	19	517.0624	Combination spanners, offset, 24 mm	1	31	503.4612	GEARplus reversing combination ratcheting spanner, 12 mm	1
8	517.0613	Combination spanners, offset, 13 mm	1	20	517.0625	Combination spanners, offset, 25 mm	1	32	503.4613	GEARplus reversing combination ratcheting spanner, 13 mm	1
9	517.0614	Combination spanners, offset, 14 mm	1	21	517.0626	Combination spanners, offset, 26 mm	1				
10	517.0615	Combination spanners, offset, 15 mm	1	22	517.0627	Combination spanners, offset, 27 mm	1				
11	517.0616	Combination spanners, offset, 16 mm	1	23	517.0628	Combination spanners, offset, 28 mm	1				
12	517.0617	Combination spanners, offset, 17 mm	1	24	517.0629	Combination spanners, offset, 29 mm	1				

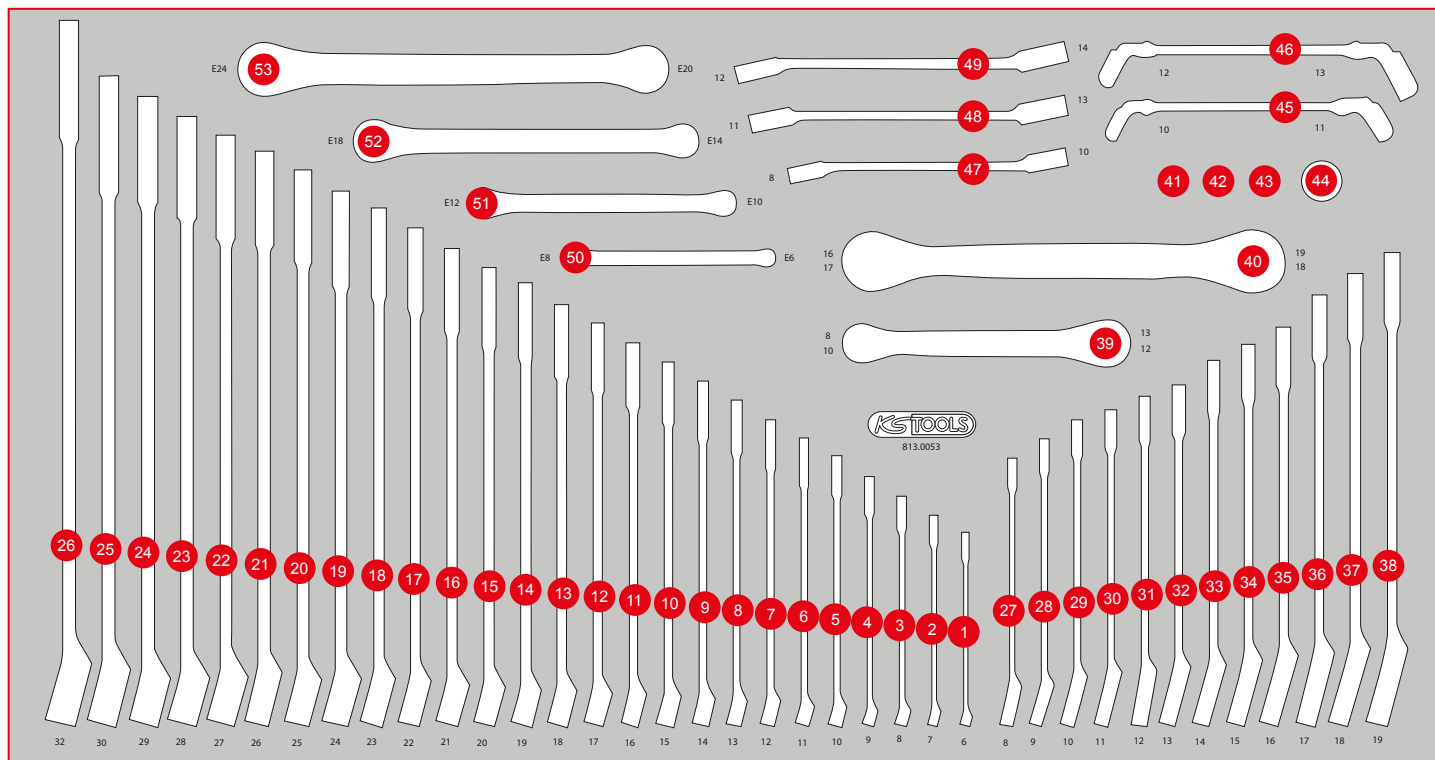

Pos.	Code	Description	pcs	Pos.	Code	Description	pcs	Pos.	Code	Description	pcs
33	503.4614	GEARplus reversing combination ratcheting spanner, 14 mm	1	40	503.4546	4 in 1 GEARplus reversing double ratchet ring spanner, 16x17x18x19 mm	1	50	911.0371	Double ring spanner for Torx E profile, E6 x E8	1
34	503.4615	GEARplus reversing combination ratcheting spanner, 15 mm	1	41	503.4290	GEARplus bit adaptor, 1/4" x 10 mm	1	51	911.0373	Double ring spanner for Torx E profile, E10 x E12	1
35	503.4616	GEARplus reversing combination ratcheting spanner, 16 mm	1	42	503.4296	GEARplus socket adaptor, 1/4" x 10 mm	1	52	911.0374	Double ring spanner for Torx E profile, E14 x E18	1
36	503.4617	GEARplus reversing combination ratcheting spanner, 17 mm	1	43	503.4297	GEARplus socket adaptor, 3/8" x 13 mm	1	53	911.0376	Double ring spanner for Torx E profile, E20 x E24	1
37	503.4618	GEARplus reversing combination ratcheting spanner, 18 mm	1	44	503.4298	GEARplus socket adaptor, 1/2" x 19 mm	1				
38	503.4619	GEARplus reversing combination ratcheting spanner, 19 mm	1	45	518.0528	Open double ring spanner, with double joint, 10 x 11	1				
39	503.4656	4 in 1 GEARplus reversing double ratchet ring spanner, 8x10+12x13 mm	1	46	518.0529	Open double ring spanner, with double joint, 12 x 13	1				
				47	517.0252	Open double ring spanner, offset, 8 x 10 mm	1				
				48	517.9244	Open double ring spanner, offset, 11 x 13 mm	1				
				49	517.0258	Open double ring spanner, offset, 12 x 14 mm	1				

813.0024

## L T-handle angle wrench and screwdriver set

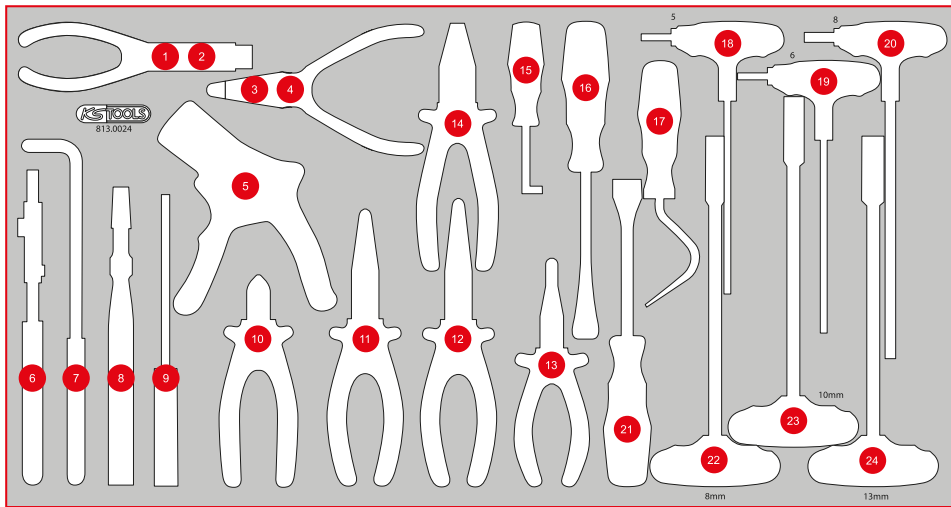

Pos.	Code	Description	pcs
1	500.1035	Circlip pliers for internal circlips, 160 mm	1
2	500.1032	Circlip pliers for internal circlips, angled, 160 mm	1
3	500.1029	Circlip pliers for external circlips, 160 mm	1
4	500.1026	Circlip pliers for external circlips, angled, 160 mm	1
5	115.1239	Self regulating wire stripper, 0,2-6 mm	1
6	115.2010	Water pump pliers, 240 mm	1
7	500.7053	Telephone pliers 90° curved, extra long, 270 mm	1
8	115.1033	Self grip wrench, 220 mm	1
9	115.1231	Multifunction pliers for insulated and non insulated cable terminals, 220 mm	1
10	115.1012	ERGOTORQUE diagonal side cutter, 160 mm	1
11	115.1019	ERGOTORQUE bent nose pliers serrated, 210 mm	1
12	115.1024	ERGOTORQUE long nose pliers serrated cutter, 200 mm	1
13	115.1016	ERGOTORQUE flat pliers serrated, 160 mm	1
14	115.1021	ERGOTORQUE combination pliers, 180 mm	1
15	550.1048	Hook, 90° offset	1
16	140.2373	Clip remover short, length 245 mm, Opening 10 mm	1
17	550.1073	Hook, large, sickle	1
18	151.8134	T-handle ball ended hexagon key wrench, 5 mm	1
19	151.8135	T-handle ball ended hexagon key wrench, 6 mm	1
20	151.8137	T-handle ball ended hexagon key wrench, 8 mm	1
21	140.2616	Clip remover, short 7,5 mm	1
22	158.5008	T-handle socket screwdriver, long, 8 mm	1
23	158.5010	T-handle socket screwdriver, long, 10 mm	1
24	158.5013	T-handle socket screwdriver, long, 13 mm	1

813.1036

# L Hammer, chisel and measuring tool set

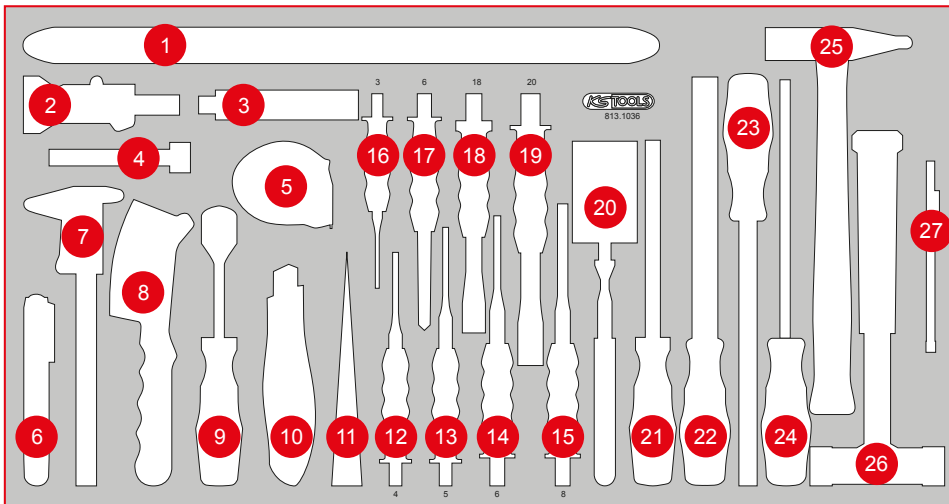

Pos.	Code	Description	pcs
1	911.8199	Tyre iron for installing and removing tyres with replaceable plastic coating, 500 mm	1
2	300.0550	Digital depth gauge 0-25 mm, 125 mm	1
3	907.2206	Trapezoid blades, pack of 10	10
4	300.0600	Feeler gauge, 20 Blades, 0,05 - 1 mm	1
5	300.0114	Tape measure with locking device and belt clip, black red, 5 m, 19 mm	1
6	150.2199	Brake fluid tester	1
7	300.0510	Pocket vernier calliper 0-150 mm, 235 mm	1
8	201.2320	Steel wire brake saddle wire brush 2 rowed, straight	1
9	907.2222	Gasket scraper, 25 x 200 mm	1
10	907.2140	Professional safety universal knife, 145 mm	1
11	911.8138	Trim plastic wedge, 195 mm x B = 30 mm	1
12	156.0232	Pin punch, Ø 4 mm, cylindrical shaft	1
13	156.0233	Pin punch, Ø 5 mm, cylindrical shaft	1
14	156.0234	Pin punch, Ø 6 mm, cylindrical shaft	1
15	156.0235	Pin punch, Ø 8 mm, cylindrical shaft	1
16	156.0231	Pin punch, Ø 3 mm, cylindrical shaft	1
17	156.0243	Centre punch, octagon 10 mm	1
18	156.0241	Flat chisel, octagon, 20 mm	1
19	156.0254	Flat chisel, octagon, 18 mm	1
20	550.1136	Flexible inspection mirror with lighting	1
21	157.0960	Brake saddle file, extra narrow, 270 mm	1
22	157.0105	Halfround file, form E, cut 2, 20 mm	1
23	157.0405	Tri-bastard file, form C, cut 2, 200 mm	1
24	157.0205	Round file, form F, cut 2, 200 mm	1
25	142.1402	Fitters Hammer, fibreglas handle, 400 g	1
26	140.5271	Recoil free soft faced Hammer, 480 g	1
27	550.1001	2 in 1 Telescopic solenoid holder with washer jet cleaning and setting tool, 150 - 675 mm	1

# P25

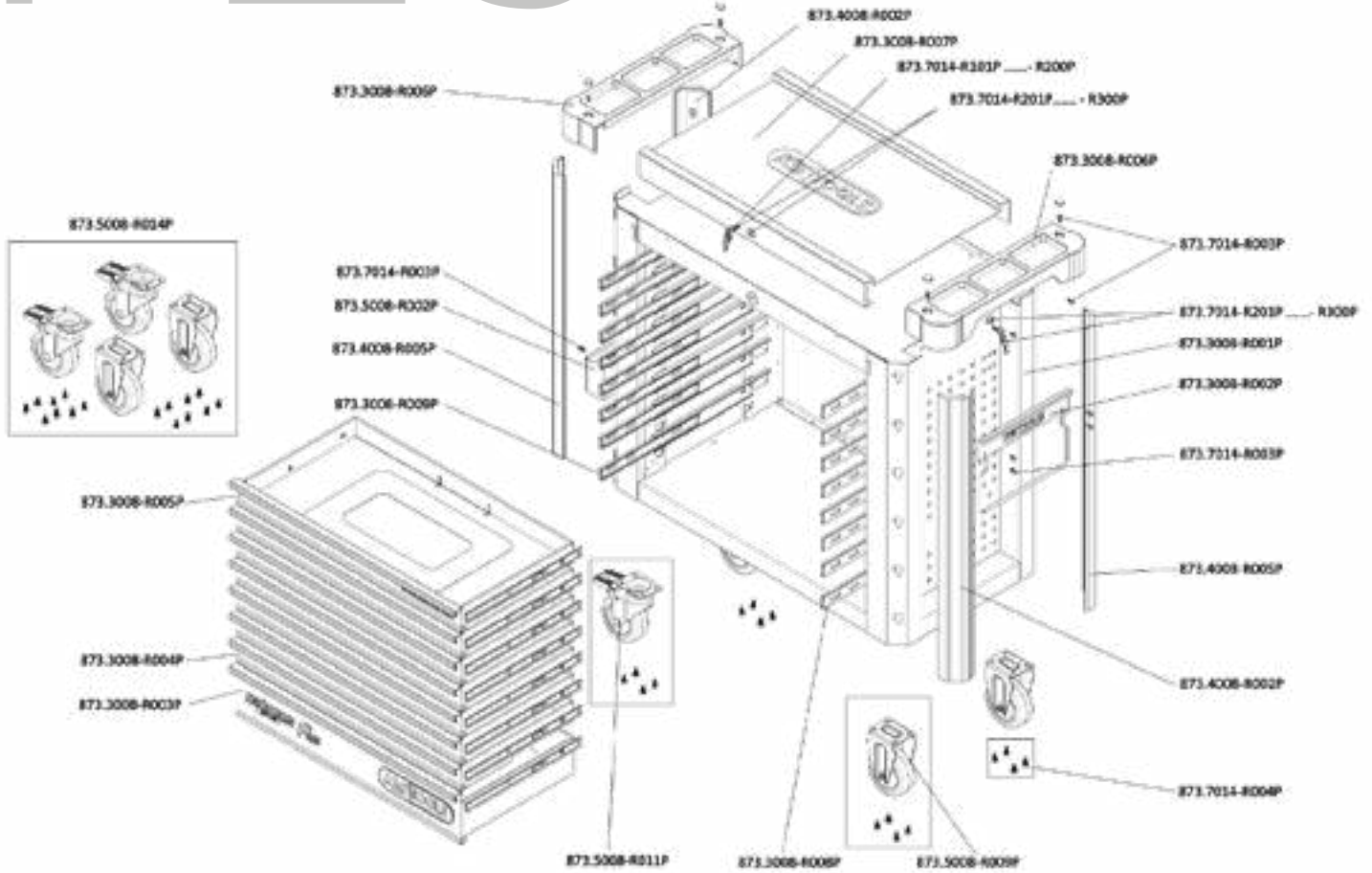

## INDIVIDUAL PARTS LIST

Art.-Nr.	Description	amount
873.7014-R101P...	Replacement key for PERFORMANCEplus workshop trolley lock number xyz	2
873.7014-R201P...	Lock with 2 keys for PERFORMANCEplus workshop trolley lock number xyz	2
873.3008-R001P	Body with handle	1
873.3008-R002P	Paper roll holder for PERFORMANCEplus workshop trolley P10/P15/P25	1
873.3008-R003P	Compartment with logo and ball-bearing guide, 755x398x145 mm	1
873.3008-R004P	Compartment with ball-bearing guide, 755x398x65 mm	6
873.3008-R005P	Compartment with website and ball-bearing guide, 755x398x65 mm	1
873.3008-R006P	Storage for work surface	2
873.3008-R007P	Stainless steel work surface	1
873.3008-R008P	Full extension (with ball-bearing guide) with automatic retraction	8
873.3008-R009P	Full extension (with ball-bearing guide) with automatic retraction	8
873.4008-R002P	Plastic bumpers	2
873.4008-R005P	Plastic bumpers	2
873.5008-R002P	Can holder for PERFORMANCEplus workshop trolley P10/P15/P25/P35	1
873.5008-R009P	Fixed castors for PERFORMANCEplus workshop trolley, incl. screws	2
873.5008-R011P	Swivel castors with brakes, for PERFORMANCEplus workshop trolley, incl. screws	2
873.5008-R014P	Roller set for PERFORMANCEplus workshop trolley, incl. screws	1
873.7014-R003P	M6x12 screw (1 pcs.) for PERFORMANCEplus workshop trolley accessories	14
873.7014-R004P	M8 screws for PERFORMANCEplus workshop trolley rollers (16 pcs.)	1



**873.7014-R101P...R200P**  
Replacement key for lock number xyz



**873.7014-R201P...R300P**  
Lock with 2 keys, lock number xyz



**873.3008-R008P**  
Full extension (with ball-bearing guide) with automatic retraction, right



**873.3008-R009P**  
Full extension with self-closing, for drawer, left



**873.5008-R009P**  
Fixed castors, incl. screws



**873.5008-R011P**  
Swivel castors with brakes, incl. screws

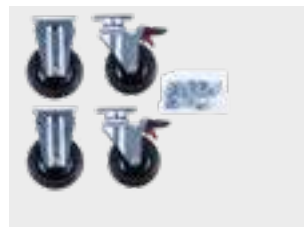

**873.5008-R014P**  
Roller set, incl. screws



**873.3008-R007P**  
Stainless steel work surface



**873.3008-R006P**  
Storage for work surface, including screw cover, usable on both sides



**873.3008-R005P**  
Compartment with website and ball-bearing guide, 755x398x65 mm



**873.3008-R004P**  
Compartment with ball-bearing guide, 755x398x65 mm



**873.3008-R003P**  
Compartment with logo and ball-bearing guide, 755x398x145 mm



**873.5008-R002P**  
Can holder including screws, W = 310 mm



**873.3008-R002P**  
Paper roll holder including screws, W= 320 mm



**873.4008-R005P**  
Plastic bumpers, front left, back right



**873.4008-R002P**  
Plastic bumpers, front right, back left



**873.7014-R004P**  
M8 screws (16 pcs.)



**873.7014-R003P**  
M6x12 screw (1 pcs.)



**873.3008-R001P**  
Body of workshop trolley attachment



Enough spares for  
your treasure!