

P25

workshop tool trolley
with 660 tools for 8 drawers
825.8660

PRECIOUS WIDTH



Workshop trolley P25
with 8 compartments
873.3008



DUO Lock Brilliant locking system



8 Drawers each load capacity up to 50 kg

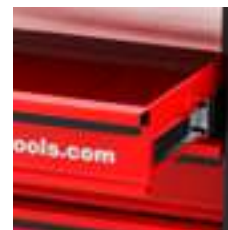

Stable **ball bearing**



Stainless steel surface



Lock lockable



Anti-static castors with brakes



Integrated **corner protection**



Paper roll holder included



Can holder included

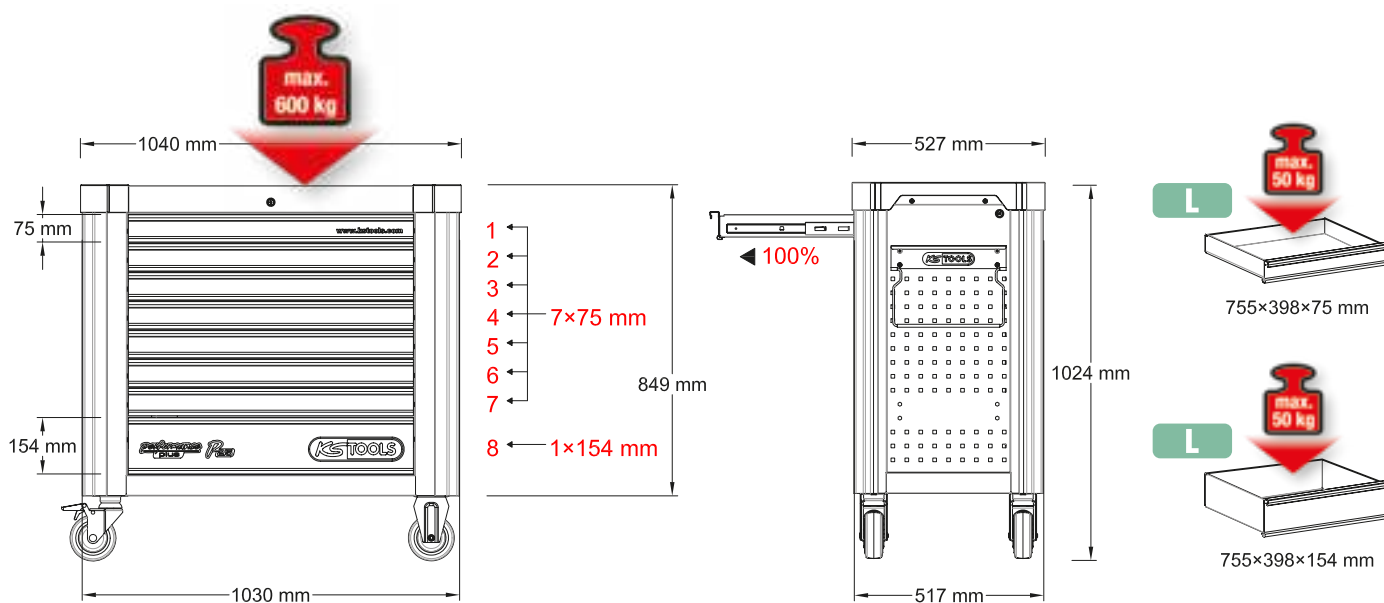

P25 workshop tool trolley set with 660 tools for 8 drawers

825.8660



IPCS
660

L

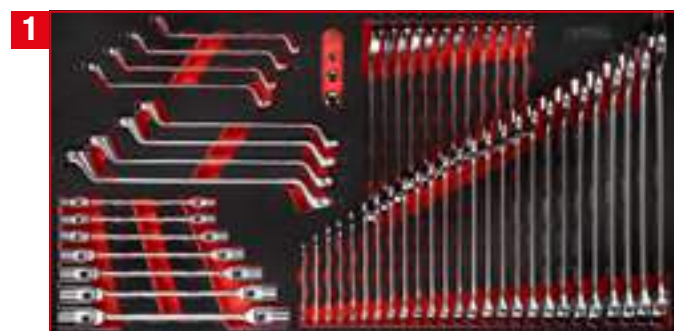

Screw spanner set in
foam insert

813.0057

IPCS
57

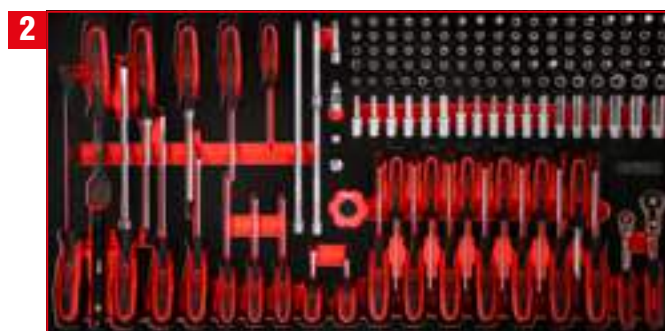

1/4" socket spanner and
screwdriver set

813.0146

IPCS
146



3/8" socket spanner set in foam insert

813.0165

165 PCS



1/2" socket spanner set in foam insert

813.0120

120 PCS



Screw spanner set in foam insert

813.0068

68 PCS



T-handle angle spanner and file set in foam insert

813.0028

28 PCS



Pliers and measuring tool set in foam insert

813.0036

36 PCS



Hammer, chisel and impact socket set in foam insert

813.0040

40 PCS

813.0057

L Screw spanner set



755 x 398

P25



Pos.	Code	Description	pcs	Pos.	Code	Description	pcs	Pos.	Code	Description	pcs
1	517.0606	Combination spanners, offset, 6 mm	1	13	517.0618	Combination spanners, offset, 18 mm	1	25	517.0630	Combination spanners, offset, 30 mm	1
2	517.0607	Combination spanners, offset, 7 mm	1	14	517.0619	Combination spanners, offset, 19 mm	1	26	517.0632	Combination spanners, offset, 32 mm	1
3	517.0608	Combination spanners, offset, 8 mm	1	15	517.0620	Combination spanners, offset, 20 mm	1	27	503.4608	GEARplus reversing combination ratcheting spanner, 8 mm	1
4	517.0609	Combination spanners, offset, 9 mm	1	16	517.0621	Combination spanners, offset, 21 mm	1	28	503.4609	GEARplus reversing combination ratcheting spanner, 9 mm	1
5	517.0610	Combination spanners, offset, 10 mm	1	17	517.0622	Combination spanners, offset, 22 mm	1	29	503.4610	GEARplus reversing combination ratcheting spanner, 10 mm	1
6	517.0611	Combination spanners, offset, 11 mm	1	18	517.0623	Combination spanners, offset, 23 mm	1	30	503.4611	GEARplus reversing combination ratcheting spanner, 11 mm	1
7	517.0612	Combination spanners, offset, 12 mm	1	19	517.0624	Combination spanners, offset, 24 mm	1	31	503.4612	GEARplus reversing combination ratcheting spanner, 12 mm	1
8	517.0613	Combination spanners, offset, 13 mm	1	20	517.0625	Combination spanners, offset, 25 mm	1	32	503.4613	GEARplus reversing combination ratcheting spanner, 13 mm	1
9	517.0614	Combination spanners, offset, 14 mm	1	21	517.0626	Combination spanners, offset, 26 mm	1				
10	517.0615	Combination spanners, offset, 15 mm	1	22	517.0627	Combination spanners, offset, 27 mm	1				
11	517.0616	Combination spanners, offset, 16 mm	1	23	517.0628	Combination spanners, offset, 28 mm	1				
12	517.0617	Combination spanners, offset, 17 mm	1	24	517.0629	Combination spanners, offset, 29 mm	1				

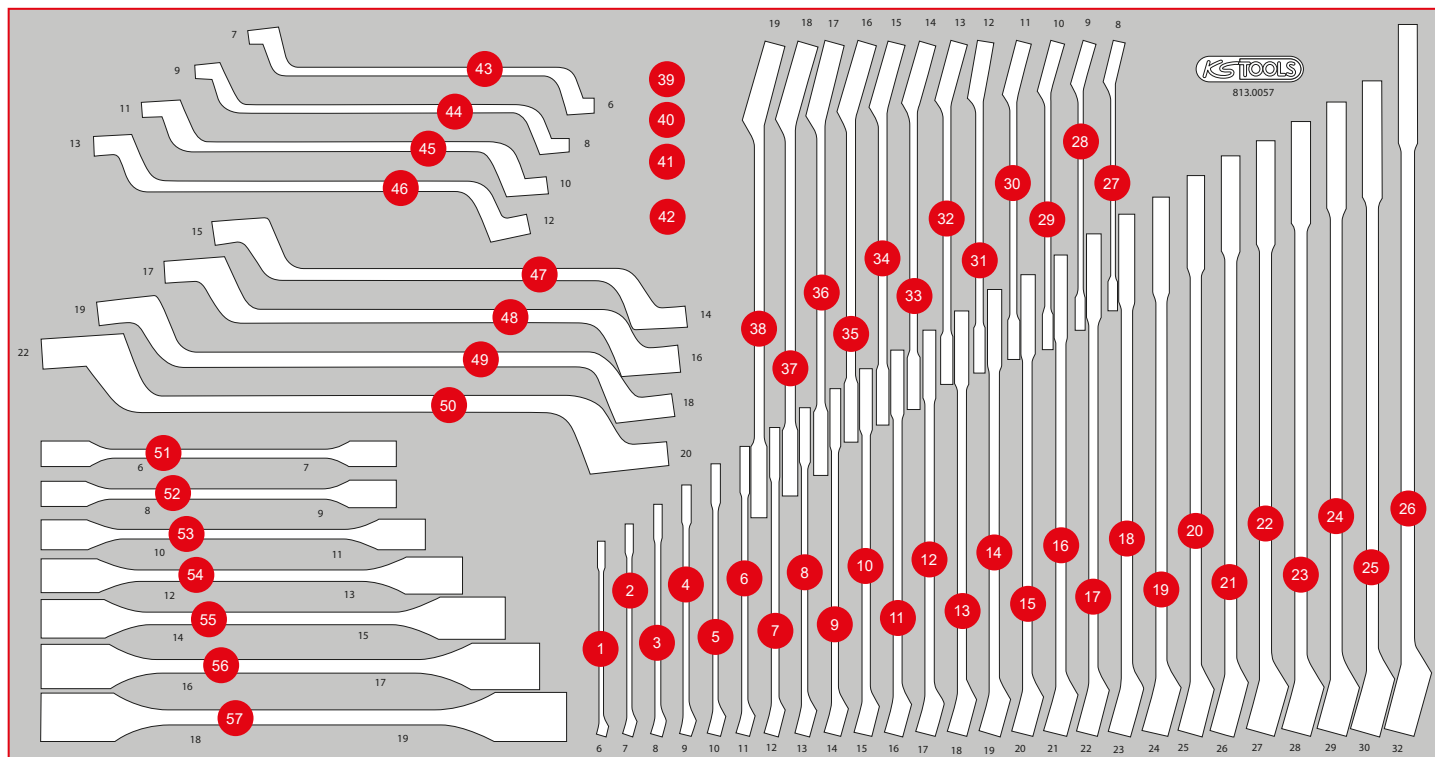

Pos.	Code	Description	pcs	Pos.	Code	Description	pcs	Pos.	Code	Description	pcs
33	503.4614	GEARplus reversing combination ratcheting spanner, 14 mm	1	41	503.4297	GEARplus socket adaptor, 3/8" x 13 mm	1	53	517.0302	Double revolving head spanner, 10 x 11 mm	1
34	503.4615	GEARplus reversing combination ratcheting spanner, 15 mm	1	42	503.4298	GEARplus socket adaptor, 1/2" x 19 mm	1	54	517.0303	Double revolving head spanner, 12 x 13 mm	1
35	503.4616	GEARplus reversing combination ratcheting spanner, 16 mm	1	43	517.0801	Double ring spanner, offset, 6 x 7 mm	1	55	517.0304	Double revolving head spanner, 14 x 15 mm	1
36	503.4617	GEARplus reversing combination ratcheting spanner, 17 mm	1	44	517.0802	Double ring spanner, offset, 8 x 9 mm	1	56	517.0305	Double revolving head spanner, 16 x 17 mm	1
37	503.4618	GEARplus reversing combination ratcheting spanner, 18 mm	1	45	517.0804	Double ring spanner, offset, 10 x 11 mm	1	57	517.0306	Double revolving head spanner, 18 x 19 mm	1
38	503.4619	GEARplus reversing combination ratcheting spanner, 19 mm	1	46	517.0807	Double ring spanner, offset, 12 x 13 mm	1				
39	503.4290	GEARplus bit adaptor, 1/4" x 10 mm	1	47	517.0809	Double ring spanner, offset, 14 x 15 mm	1				
40	503.4296	GEARplus socket adaptor, 1/4" x 10 mm	1	48	517.0810	Double ring spanner, offset, 16 x 17 mm	1				
				49	517.0812	Double ring spanner, offset, 18 x 19 mm	1				
				50	517.0813	Double ring spanner, offset, 20 x 22 mm	1				
				51	517.0300	Double revolving head spanner, 6 x 7 mm	1				
				52	517.0301	Double revolving head spanner, 8 x 9 mm	1				

L 1/4" Socket spanner and screwdriver set



755 x 398

P25

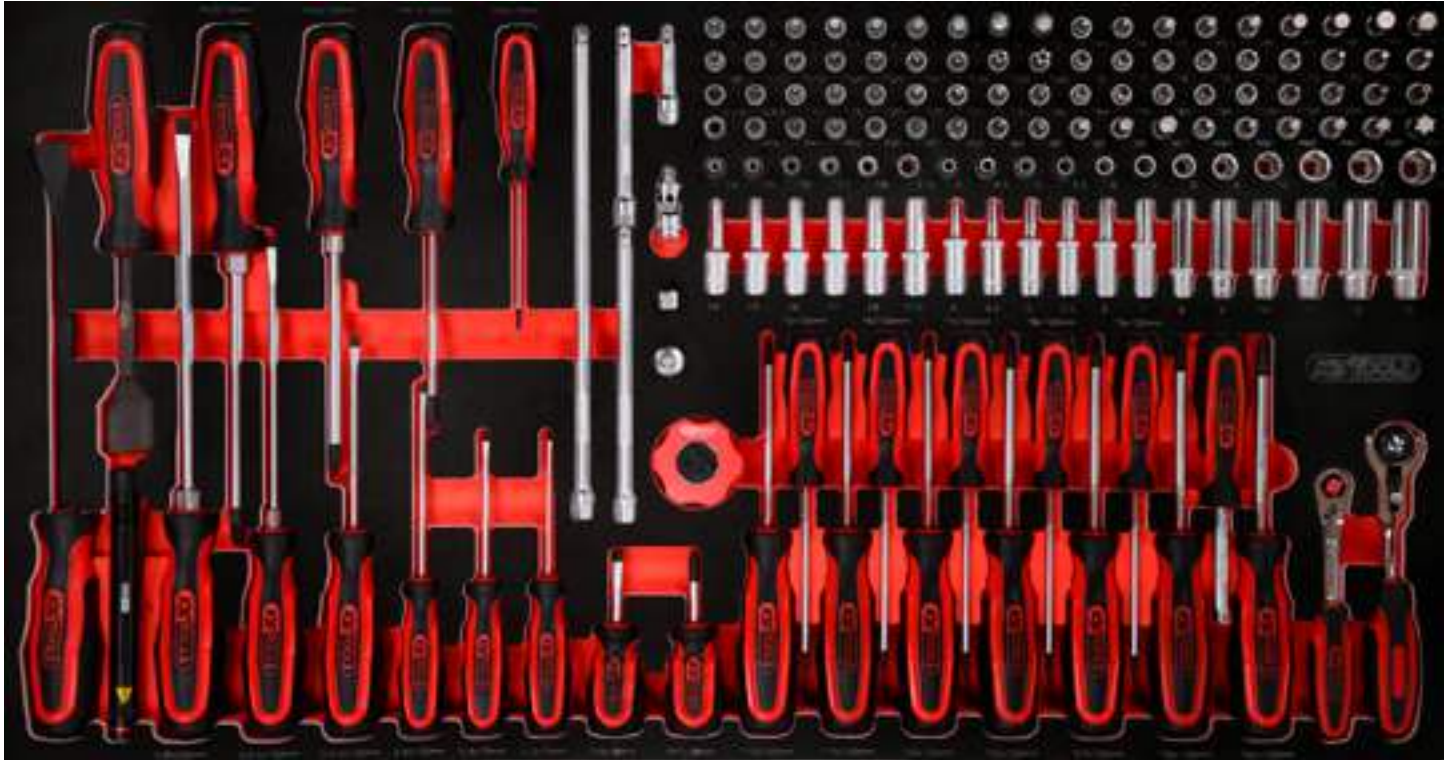

Pos.	Code	Description	pcs	Pos.	Code	Description	pcs	Pos.	Code	Description	pcs
1	911.8102	Pry bar, 15 x 185 mm	1	21	911.3897	3/8" Reducing adaptor, 3/8"F x 1/4"M	1	50	911.4407	1/4" Bit socket Torx, T6	1
2	159.1024	ERGOTORQUEplus screwdriver, Torx, PH3, 265 mm	1	22	914.1410	Mini hand reversible ratchet, 1/4", 72 teethh	1	51	911.4362	1/4" Bit socket Torx, T7	1
3	159.1022	ERGOTORQUEplus screwdriver, Torx, PH2, 230 mm	1	23	917.2443	Hex bit socket,ball ended,1/4", 3 mm	1	52	911.1448	1/4" Bit socket Torx, T8	1
4	159.1029	ERGOTORQUEplus screwdriver, Torx, PH1, 205 mm	1	24	917.2444	Hex bit socket,ball ended,1/4", 4 mm	1	53	911.1478	1/4" Bit socket Torx, T9	1
5	159.1027	ERGOTORQUEplus screwdriver, Torx, PH0, 155 mm	1	25	917.2445	Hex bit socket,ball ended,1/4", 5 mm	1	54	911.1442	1/4" Bit socket Torx, T10	1
6	911.8103	Pry bar, 18 x 320 mm	1	26	917.24455	Hex bit socket,ball ended,1/4", 5,5 mm	1	55	911.1443	1/4" Bit socket Torx, T15	1
7	159.1011	ERGOTORQUEplus screwdriver for slotted screws, 8 mm, 315 mm long	1	27	917.2446	Hex bit socket,ball ended,1/4", 6 mm	1	56	911.1444	1/4" Bit socket Torx, T20	1
8	159.1009	ERGOTORQUEplus screwdriver for slotted screws, 6,5 mm, 255 mm long	1	28	917.2447	Hex bit socket,ball ended,1/4", 7 mm	1	57	911.1445	1/4" Bit socket Torx, T25	1
9	159.1006	ERGOTORQUEplus screwdriver for slotted screws, 5,5 mm, 230 mm long	1	29	917.2448	Hex bit socket,ball ended,1/4", 8 mm	1	58	911.1449	1/4" Bit socket Torx, T27	1
10	159.1004	ERGOTORQUEplus screwdriver for slotted screws, 4 mm, 180 mm long	1	30	917.2449	Hex bit socket,ball ended,1/4", 9 mm	1	59	911.1419	1/4" Bit socket slot, 5,5 mm	1
11	159.1003	ERGOTORQUEplus screwdriver for slotted screws, 4 mm, 155 mm long	1	31	917.2450	Hex bit socket,ball ended,1/4", 10 mm	1	60	917.1421	1/4" Bit socket slot, 6,5 mm	1
12	159.1002	ERGOTORQUEplus screwdriver for slotted screws, 3 mm, 155 mm long	1	32	911.1436	1/4" Bit socket hexagon, 3 mm	1	61	911.3771	1/4" Bit socket Torx, ball ended, T10	1
13	159.1001	ERGOTORQUEplus screwdriver for slotted screws, short, 6 mm	1	33	911.1437	1/4" Bit socket hexagon, 4 mm	1	62	911.3772	1/4" Bit socket Torx, ball ended, T15	1
14	159.1141	ERGOTORQUEplus screwdriver, Torx, short, PH1	1	34	911.1438	1/4" Bit socket hexagon, 5 mm	1	63	911.3773	1/4" Bit socket Torx, ball ended, T20	1
15	911.1543	1/4" Wobble extension with hexagon drive, 250 mm	1	35	911.14385	1/4" Bit socket hexagon, 5,5 mm	1	64	911.3774	1/4" Bit socket Torx, ball ended, T25	1
16	911.1424	1/4" Extension with hexagon drive, 100 mm	1	36	911.1439	1/4" Bit socket hexagon, 6 mm	1	65	911.3775	1/4" Bit socket Torx, ball ended, T27	1
17	911.1451	1/4" Extension with hexagon drive, 150 mm	1	37	911.1440	1/4" Bit socket hexagon, 7 mm	1	66	911.3776	1/4" Bit socket Torx, ball ended, T30	1
18	911.1423	1/4" Extension with hexagon drive, 50 mm	1	38	911.1441	1/4" Bit socket hexagon, 8 mm	1	67	911.3777	1/4" Bit socket Torx, ball ended, T40	1
19	911.1450	1/4" Universal joint	1	39	917.1454	1/4" Bit socket hexagon, 9 mm	1	68	917.1456	1/4" Bit socket Torx tamperproof, TB6	1
20	911.1494	1/4" Adaptor, 1/4"F x 3/8"M	1	40	917.1452	1/4" Bit socket hexagon, 10 mm	1	69	917.1457	1/4" Bit socket Torx tamperproof, TB7	1
				41	917.1578	1/4" Torx Plus Bit-Socket 8IPR	1	70	911.1461	1/4" Bit socket Torx tamperproof, TB8	1
				42	911.1701	1/4" Bit socket five star tamperproof, TS10	1	71	911.1485	1/4" Bit socket Torx tamperproof, TB9	1
				43	911.1702	1/4" Bit socket five star tamperproof, TS15	1	72	911.1462	1/4" Bit socket Torx tamperproof, TB10	1
				44	911.1703	1/4" Bit socket five star tamperproof, TS20	1	73	911.1463	1/4" Bit socket Torx tamperproof, TB15	1
				45	911.1704	1/4" Bit socket five star tamperproof, TS25	1	74	911.1464	1/4" Bit socket Torx tamperproof, TB20	1
				46	911.1705	1/4" Bit socket five star tamperproof, TS27	1	75	911.1465	1/4" Bit socket Torx tamperproof, TB25	1
				47	911.1706	1/4" Bit socket five star tamperproof, TS30	1	76	911.1466	1/4" Bit socket Torx tamperproof, TB27	1
				48	911.1707	1/4" Bit socket five star tamperproof, TS40	1	78	911.1482	1/4" Bit socket, PH0	1
				49	911.1708	1/4" Bit socket five star tamperproof, TS45	1	79	911.1415	1/4" Bit socket, PH1	1
								80	911.1416	1/4" Bit socket, PH2	1

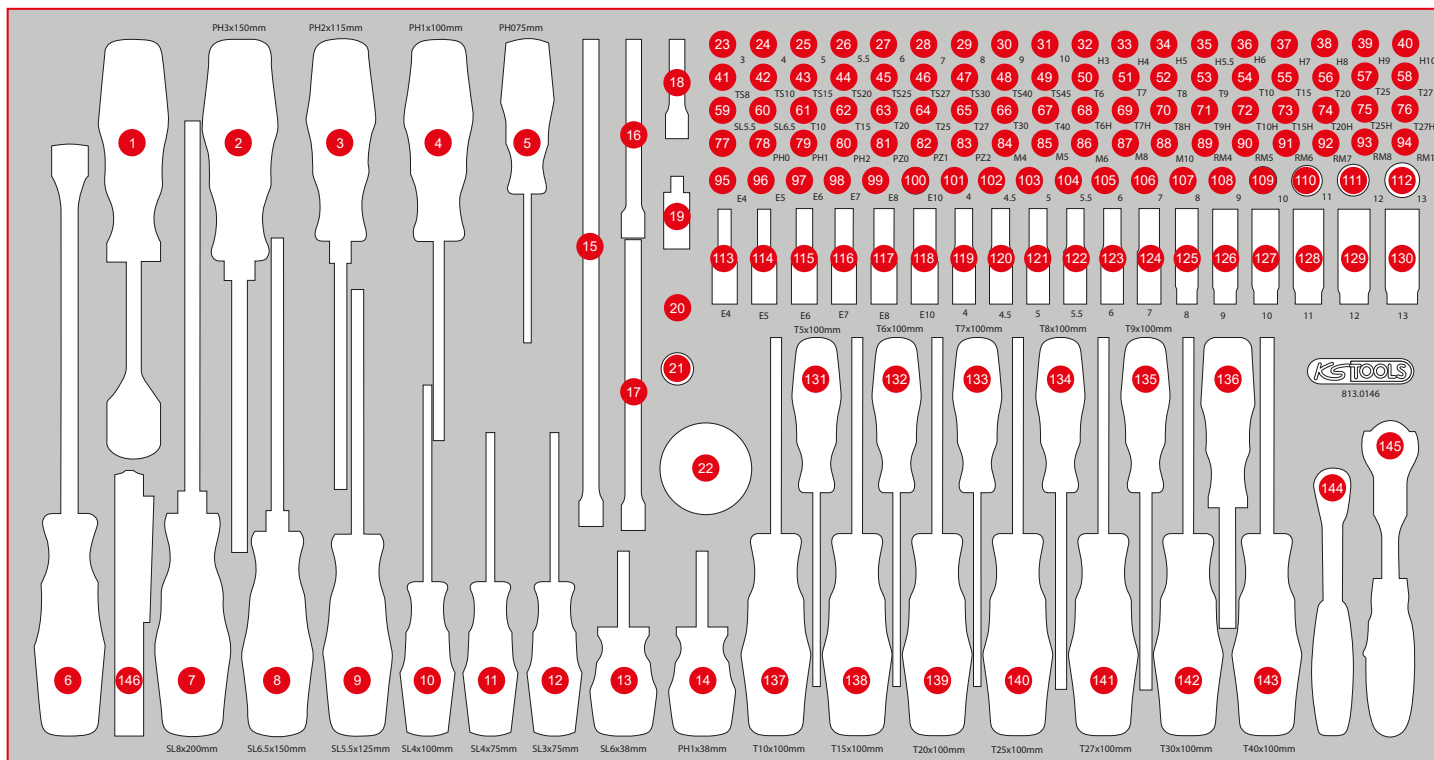

Pos.	Code	Description	pcs	Pos.	Code	Description	pcs	Pos.	Code	Description	pcs
81	911.1483	1/4" Bit socket, PZ0	1	109	917.1410	1/4" Hexagonal socket, 10 mm	1	138	159.1033	ERGOTORQUEplus screwdriver, Torx, T15	1
82	911.1401	1/4" Bit socket, PZ1	1	110	917.1411	1/4" Hexagonal socket, 11 mm	1	139	159.1034	ERGOTORQUEplus screwdriver, Torx, T20	1
83	911.1402	1/4" Bit socket, PZ2	1	111	917.1412	1/4" Hexagonal socket, 12 mm	1	140	159.1035	ERGOTORQUEplus screwdriver, Torx, T25	1
84	917.1541	1/4" Bit socket spline (XZN), M4	1	112	917.1413	1/4" Hexagonal socket, 13 mm	1	141	159.1036	ERGOTORQUEplus screwdriver, Torx, T27	1
85	917.1542	1/4" Bit socket spline (XZN), M5	1	113	917.2401	1/4" Torx E Socket, deep, E4	1	142	159.1037	ERGOTORQUEplus screwdriver, Torx, T30	1
86	917.1543	1/4" Bit socket spline (XZN), M6	1	114	917.2402	1/4" Torx E Socket, deep, E5	1	143	159.1038	ERGOTORQUEplus screwdriver, Torx, T40	1
87	917.1545	1/4" Bit socket spline (XZN), M8	1	115	917.2403	1/4" Torx E Socket, deep, E6	1	144	920.1490	1/4" SlimPOWER Reversible ratchet, 72 teeth	1
88	917.1546	1/4" Bit socket spline (XZN), M10	1	116	917.2404	1/4" Torx E Socket, deep, E7	1	145	914.1405	1/4" MODIFIX mini T-handle swivel head ratchet, 72 teeth	1
89	917.1584	1/4" RIBE Socket M4S	1	117	917.2405	1/4" Torx E Socket, deep, E8	1	146	150.4370	perfectLight torch 85 lumen	1
90	917.1585	1/4" RIBE Socket M5S	1	118	917.2406	1/4" Torx E Socket, deep, E10	1				
91	917.1586	1/4" RIBE Socket M6S	1	119	917.1525	1/4" Hexagonal socket, deep, 4 mm	1				
92	917.1587	1/4" RIBE Socket M7S	1	120	917.1526	1/4" Hexagonal socket, deep, 4,5 mm	1				
93	917.1588	1/4" RIBE Socket M8S	1	121	917.1527	1/4" Hexagonal socket, deep, 5 mm	1				
94	917.1590	1/4" RIBE Socket M10S	1	122	917.1528	1/4" Hexagonal socket, deep, 5,5 mm	1				
95	911.4313	1/4" Torx E Socket, E4	1	123	917.1426	1/4" Hexagonal socket, deep, 6 mm	1				
95	911.0101	1/4" socket with magnet	1	124	917.1427	1/4" Hexagonal socket, deep, 7 mm	1				
96	911.4314	1/4" Torx E Socket, E5	1	125	917.1428	1/4" Hexagonal socket, deep, 8 mm	1				
97	911.4315	1/4" Torx E Socket, E6	1	126	917.1429	1/4" Hexagonal socket, deep, 9 mm	1				
98	911.4316	1/4" Torx E Socket, E7	1	127	917.1430	1/4" Hexagonal socket, deep, 10 mm	1				
99	911.4317	1/4" Torx E Socket, E8	1	128	917.1431	1/4" Hexagonal socket, deep, 11 mm	1				
100	911.4332	1/4" Torx E Socket, E10	1	129	917.1432	1/4" Hexagonal socket, deep, 12 mm	1				
101	917.1404	1/4" Hexagonal socket, 4 mm	1	130	917.1433	1/4" Hexagonal socket, deep, 13 mm	1				
102	917.14045	1/4" Hexagonal socket, 4,5 mm	1	131	159.1133	ERGOTORQUEplus screwdriver, Torx, T5	1				
103	917.1405	1/4" Hexagonal socket, 5 mm	1	132	159.1134	ERGOTORQUEplus screwdriver, Torx, T6	1				
104	917.14055	1/4" Hexagonal socket, 5,5 mm	1	133	159.1135	ERGOTORQUEplus screwdriver, Torx, T7	1				
105	917.1406	1/4" Hexagonal socket, 6 mm	1	134	159.1030	ERGOTORQUEplus screwdriver, Torx, T8	1				
106	917.1407	1/4" Hexagonal socket, 7 mm	1	135	159.1031	ERGOTORQUEplus screwdriver, Torx, T9	1				
107	917.1408	1/4" Hexagonal socket, 8 mm	1	136	911.1434	1/4" Square drive screwdriver, 150 mm	1				
108	917.1409	1/4" Hexagonal socket, 9 mm	1	137	159.1032	ERGOTORQUEplus screwdriver, Torx, T10	1				

813.0165

L 3/8" Socket spanner set



Pos.	Code	Description	pcs	Pos.	Code	Description	pcs	Pos.	Code	Description	pcs
1	516.1432	1/2" ERGOTORQUE® precision torque wrench with rotary mushroom ratchet head, 20-100Nm	1	27	911.1564	3/8" Bit socket hexagon, long, 7 mm	1	56	911.4390	3/8" Torx E socket, E10, long	1
2	516.1428	Rotary square box wrench, 1/2"x3/8"	1	28	911.1565	3/8" Bit socket hexagon, long, 8 mm	1	57	911.4391	3/8" Torx E socket, E11, long	1
3	920.3890	3/8" SlimPOWER Reversible ratchet, 72 teeth	1	29	917.1594	3/8" Bit socket hexagon, long, 9 mm	1	58	911.4392	3/8" Torx E socket, E12, long	1
4	914.3815	3/8" MODIFIX mini T-handle swivel head ratchet, 72 teeth, 0°+90°	1	30	911.1566	3/8" Bit socket hexagon, long, 10 mm	1	59	911.4394	3/8" Torx E socket, E14, long	1
5	917.3939	3/8" Flexi head drive handle	1	31	917.1577	3/8" Bit socket Torx, long, T10	1	60	911.4396	3/8" Torx E socket, E16, long	1
6	911.3803	3/8" Extension with knurling, 250 mm	1	32	917.1579	3/8" Bit socket Torx, long, T15	1	61	911.4398	3/8" Torx E socket, E18, long	1
7	517.1126	T-Handle universal wrench for sockets, extra long, 3/8"	1	33	911.1551	3/8" Bit socket Torx, long, T20	1	62	911.4399	3/8" Torx E socket, E20, long	1
8	911.3852	3/8" Extension with knurling, 45 mm	1	34	911.1552	3/8" Bit socket Torx, long, T25	1	63	917.4806	3/8" Hexagonal socket, deep, 6 mm	1
9	911.3801	3/8" Extension with knurling, 75 mm	1	35	911.1553	3/8" Bit socket Torx, long, T27	1	64	917.4807	3/8" Hexagonal socket, deep, 7 mm	1
10	911.0030	Wobble extension, 3/8", 300 mm	1	36	911.1554	3/8" Bit socket Torx, long, T30	1	65	917.3828	3/8" Hexagonal socket, deep, 8 mm	1
11	911.0045	Wobble extension, 3/8", 450 mm	1	37	911.1555	3/8" Bit socket Torx, long, T40	1	66	917.3829	3/8" Hexagonal socket, deep, 9 mm	1
12	911.3802	3/8" Extension with knurling, 150 mm	1	38	911.1556	3/8" Bit socket Torx, long, T45	1	67	917.3830	3/8" Hexagonal socket, deep, 10 mm	1
13	911.3931	3/8" T-Handle-Spinner	1	39	911.1557	3/8" Bit socket Torx, long, T50	1	68	917.3831	3/8" Hexagonal socket, deep, 11 mm	1
14	911.3912	Wobble extension, 3/8", 150 mm	1	40	917.3904	XZN spline bit socket, 3/8", M5, long	1	69	917.3832	3/8" Hexagonal socket, deep, 12 mm	1
15	911.3913	Wobble extension, 3/8", 200 mm	1	41	917.3905	XZN spline bit socket, 3/8", M6, long	1	70	917.3833	3/8" Hexagonal socket, deep, 13 mm	1
16	911.3910	Wobble extension, 3/8", 45 mm	1	42	917.3906	XZN spline bit socket, 3/8", M8, long	1	71	917.3834	3/8" Hexagonal socket, deep, 14 mm	1
17	911.3826	3/8" Sliding / reducing adaptor, 1/2"F x 3/8"M	1	43	917.3907	XZN spline bit socket, 3/8", M9, long	1	72	917.3835	3/8" Hexagonal socket, deep, 15 mm	1
18	911.3850	3/8" Universal joint	1	44	917.3908	XZN spline bit socket, 3/8", M10, long	1	73	917.3836	3/8" Hexagonal socket, deep, 16 mm	1
19	911.3990	3/8" Special spark plug socket, thin-walled, 14 mm	1	45	917.3909	XZN spline bit socket, 3/8", M12, long	1	74	917.3837	3/8" Hexagonal socket, deep, 17 mm	1
20	911.3804	3/8" Spark plug socket, 16 mm	1	46	917.3930	3/8" RIBE® Bit socket, long, M5	1	75	917.3838	3/8" Hexagonal socket, deep, 18 mm	1
21	911.3823	3/8" Spark plug socket, 18 mm	1	47	917.3931	3/8" RIBE® Bit socket, long, M6	1	76	917.3839	3/8" Hexagonal socket, deep, 19 mm	1
22	911.3805	3/8" Spark plug socket, 21 mm	1	48	917.3932	3/8" RIBE® Bit socket, long, M7	1	77	917.3840	3/8" Hexagonal socket, deep, 20 mm	1
23	911.1561	3/8" Bit socket hexagon, long, 4 mm	1	49	917.3933	3/8" RIBE® Bit socket, long, M8	1	78	917.3841	3/8" Hexagonal socket, deep, 21 mm	1
24	911.1562	3/8" Bit socket hexagon, long, 5 mm	1	50	917.3934	3/8" RIBE® Bit socket, long, M9	1	79	917.3842	3/8" Hexagonal socket, deep, 22 mm	1
25	911.15625	3/8" Bit socket hexagon, long, 5,5 mm	1	51	917.3935	3/8" RIBE® Bit socket, long, M10	1	80	911.4340	3/8" Torx E Socket, E6	1
26	911.1563	3/8" Bit socket hexagon, long, 6 mm	1	52	917.3936	3/8" RIBE® Bit socket, long, M12	1	81	911.4341	3/8" Torx E Socket, E7	1
				53	911.4386	3/8" Torx E socket, E6, long	1	82	911.4342	3/8" Torx E Socket, E8	1
				54	911.4387	3/8" Torx E socket, E7, long	1	83	911.4318	3/8" Torx E Socket, E10	1
				55	911.4388	3/8" Torx E socket, E8, long	1	84	911.4319	3/8" Torx E Socket, E11	1

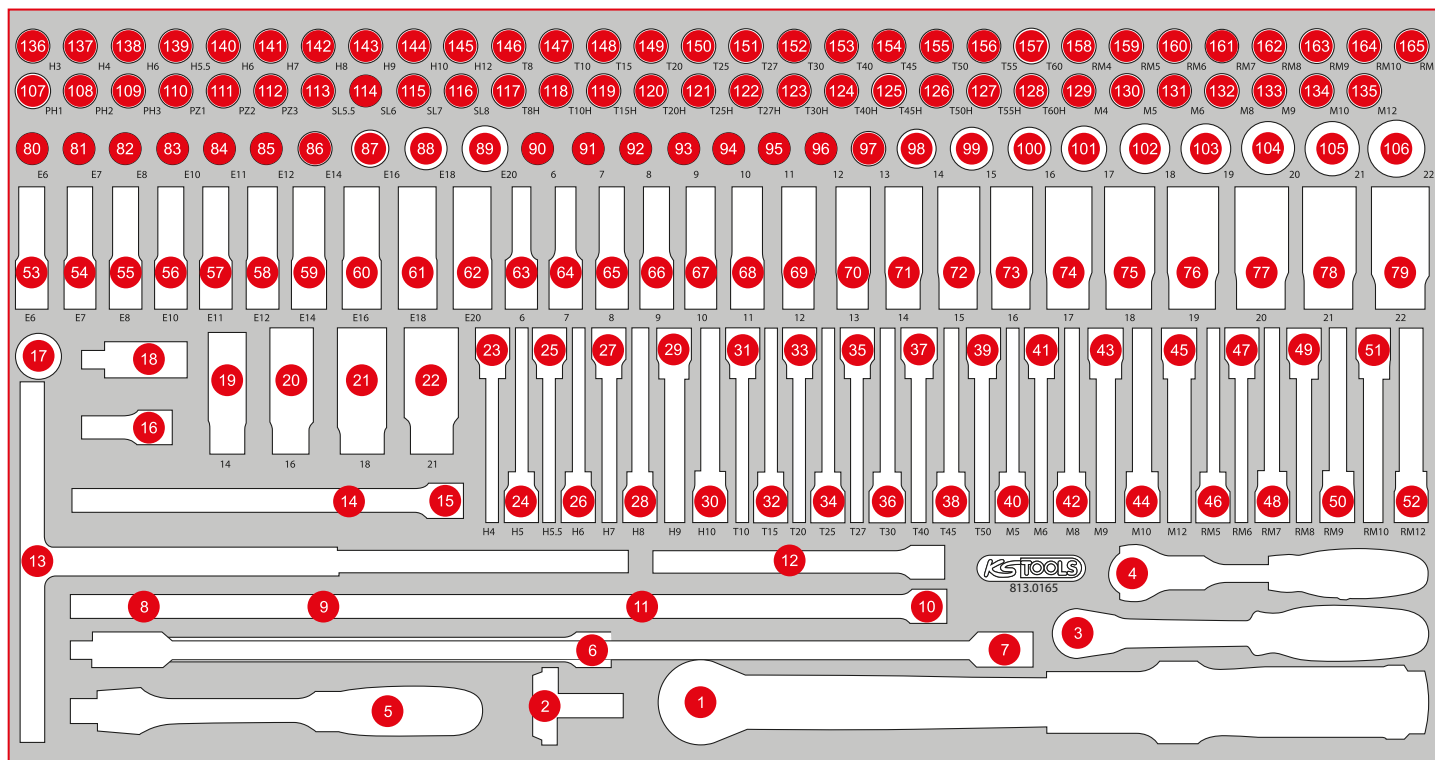

Pos.	Code	Description	pcs	Pos.	Code	Description	pcs	Pos.	Code	Description	pcs
85	911.4320	3/8" Torx E Socket, E12	1	115	911.3944	3/8" Bit socket slot 7 mm	1	144	917.3857	3/8" Bit socket hexagon, 10 mm	1
86	911.4321	3/8" Torx E Socket, E14	1	116	911.3880	3/8" Bit socket slot, 8 mm	1	145	911.3862	3/8" Bit socket hexagon, 12 mm	1
87	911.4343	3/8" Torx E Socket, E16	1	117	917.3929	3/8" Bit socket Torx tamperproof, TB8	1	146	911.3934	3/8" Bit socket Torx, T8	1
88	911.4344	3/8" Torx E Socket, E18	1	118	911.3960	3/8" Bit socket Torx tamperproof, TB10	1	147	911.3887	3/8" Bit socket Torx, T10	1
89	911.4345	3/8" Torx E Socket, E20	1	119	911.3961	3/8" Bit socket Torx tamperproof, TB15	1	148	911.3869	3/8" Bit socket Torx, T15	1
90	917.3806	3/8" Hexagonal socket, 6 mm	1	120	911.3962	3/8" Bit socket Torx tamperproof, TB20	1	149	911.3870	3/8" Bit socket Torx, T20	1
91	917.3807	3/8" Hexagonal socket, 7 mm	1	121	911.3963	3/8" Bit socket Torx tamperproof, TB25	1	150	911.3871	3/8" Bit socket Torx, T25	1
92	917.3808	3/8" Hexagonal socket, 8 mm	1	122	911.3964	3/8" Bit socket Torx tamperproof, TB27	1	151	911.3872	3/8" Bit socket Torx, T27	1
93	917.3809	3/8" Hexagonal socket, 9 mm	1	123	911.3965	3/8" Bit socket Torx tamperproof, TB30	1	152	911.3873	3/8" Bit socket Torx, T30	1
94	917.3810	3/8" Hexagonal socket, 10 mm	1	124	911.3966	3/8" Bit socket Torx tamperproof, TB40	1	153	911.3874	3/8" Bit socket Torx, T40	1
95	917.3811	3/8" Hexagonal socket, 11 mm	1	125	911.3967	3/8" Bit socket Torx tamperproof, TB45	1	154	911.3885	3/8" Bit socket Torx, T45	1
96	917.3812	3/8" Hexagonal socket, 12 mm	1	126	911.3968	3/8" Bit socket Torx tamperproof, TB50	1	155	911.3884	3/8" Bit socket Torx, T50	1
97	917.3813	3/8" Hexagonal socket, 13 mm	1	127	911.3969	3/8" Bit socket Torx tamperproof, TB55	1	156	911.3888	3/8" Bit socket Torx, T55	1
98	917.3814	3/8" Hexagonal socket, 14 mm	1	128	911.3970	3/8" Bit socket Torx tamperproof, TB60	1	157	911.3889	3/8" Bit socket Torx, T60	1
99	917.3815	3/8" Hexagonal socket, 15 mm	1	129	911.3918	3/8" Bit socket spline (XZN), M4	1	158	917.3921	3/8" RIBE® Bit socket, M4	1
100	917.3816	3/8" Hexagonal socket, 16 mm	1	130	911.3915	3/8" Bit socket spline (XZN), M5	1	159	917.3922	3/8" RIBE® Bit socket, M5	1
101	917.3817	3/8" Hexagonal socket, 17 mm	1	131	911.3916	3/8" Bit socket spline (XZN), M6	1	160	917.3923	3/8" RIBE® Bit socket, M6	1
102	917.3818	3/8" Hexagonal socket, 18 mm	1	132	911.3917	3/8" Bit socket spline (XZN), M8	1	161	917.3924	3/8" RIBE® Bit socket, M7	1
103	917.3819	3/8" Hexagonal socket, 19 mm	1	133	917.3901	3/8" Bit socket spline (XZN), M9	1	162	917.3925	3/8" RIBE® Bit socket, M8	1
104	917.3820	3/8" Hexagonal socket, 20 mm	1	134	911.3920	3/8" Bit socket spline (XZN), M10	1	163	917.3926	3/8" RIBE® Bit socket, M9	1
105	917.3821	3/8" Hexagonal socket, 21 mm	1	135	917.3903	3/8" Bit socket spline (XZN), M12	1	164	917.3927	3/8" RIBE® Bit socket, M10	1
106	917.3822	3/8" Hexagonal socket, 22 mm	1	136	911.3863	3/8" Bit socket hexagon, 3 mm	1	165	917.3928	3/8" RIBE® Bit socket, M12	1
107	911.3875	3/8" Bit socket, PH1	1	137	911.3864	3/8" Bit socket hexagon, 4 mm	1				
108	911.3876	3/8" Bit socket, PH2	1	138	911.3865	3/8" Bit socket hexagon, 5 mm	1				
109	911.3877	3/8" Bit socket, PH3	1	139	911.38655	3/8" Bit socket hexagon, 5,5 mm	1				
110	911.3881	3/8" Bit socket, PZ1	1	140	911.3866	3/8" Bit socket hexagon, 6 mm	1				
111	911.3882	3/8" Bit socket, PZ2	1	141	911.3867	3/8" Bit socket hexagon, 7 mm	1				
112	911.3883	3/8" Bit socket, PZ3	1	142	911.3868	3/8" Bit socket hexagon, 8 mm	1				
113	911.3878	3/8" Bit socket slot, 5,5 mm	1	143	917.3969	3/8" Bit socket hexagon, 9 mm	1				
114	911.3943	3/8" Bit socket slot 6 mm	1								

813.0120

L 1/2" Socket spanner set



Pos.	Code	Description	pcs	Pos.	Code	Description	pcs	Pos.	Code	Description	pcs
1	917.1223	1/2" Hexagonal socket, 23 mm	1	22	917.1213	1/2" Hexagonal socket, 13 mm	1	43	911.4336	1/2" Torx E Socket, E14	1
2	917.1224	1/2" Hexagonal socket, 24 mm	1	23	917.1214	1/2" Hexagonal socket, 14 mm	1	44	911.4322	1/2" Torx E Socket, E16	1
3	917.1343	1/2" Hexagonal socket, 26 mm	1	24	911.4513	Bit socket for RIBE screws, M7, Length 55 mm	1	45	911.4323	1/2" Torx E Socket, E18	1
4	917.1227	1/2" Hexagonal socket, 27 mm	1	25	911.4514	Bit socket for RIBE screws, M8, length 55 mm	1	46	911.4324	1/2" Torx E Socket, E20	1
5	917.1344	1/2" Hexagonal socket, 28 mm	1	26	911.4515	Bit socket for RIBE screws, M9, length 55 mm	1	47	911.4325	1/2" Torx E Socket, E22	1
6	917.1230	1/2" Hexagonal socket, 30 mm	1	27	911.4516	Bit socket for RIBE screws, M10, Length 55 mm	1	48	911.1363	1/2" Bit socket Torx, T27	1
7	917.1232	1/2" Hexagonal socket, 32 mm	1	28	911.4517	Bit socket for RIBE screws, M12, Length 55 mm	1	49	911.1364	1/2" Bit socket Torx, T30	1
8	917.1215	1/2" Hexagonal socket, 15 mm	1	29	911.4518	Bit socket for RIBE screws, M13, Length 55 mm	1	50	911.1365	1/2" Bit socket Torx, T40	1
9	917.1216	1/2" Hexagonal socket, 16 mm	1	30	911.4519	Bit socket for RIBE screws, M14, Length 55 mm	1	51	911.1366	1/2" Bit socket Torx, T45	1
10	917.1217	1/2" Hexagonal socket, 17 mm	1	31	911.4552	Bit socket for RIBE screws, M16, Length 55 mm	1	52	911.1367	1/2" Bit socket Torx, T50	1
11	917.1218	1/2" Hexagonal socket, 18 mm	1	32	911.1305	1/2" Bit socket hexagon, short, 5 mm	1	53	911.1368	1/2" Bit socket Torx, T55	1
12	917.1219	1/2" Hexagonal socket, 19 mm	1	33	911.1306	1/2" Bit socket hexagon, short, 6 mm	1	54	911.1369	1/2" Bit socket Torx, T60	1
13	917.1220	1/2" Hexagonal socket, 20 mm	1	34	911.1307	1/2" Bit socket hexagon, short, 7 mm	1	55	911.1370	1/2" Bit socket Torx, T70	1
14	917.1221	1/2" Hexagonal socket, 21 mm	1	35	911.1308	1/2" Bit socket hexagon, short, 8 mm	1	56	911.1373	1/2" Bit socket Torx tamperproof, TB27	1
16	911.1207	Sliding adaptor, 3/8" F x 1/2" M	1	36	911.1309	1/2" Bit socket hexagon, short, 9 mm	1	57	911.1374	1/2" Bit socket Torx tamperproof, TB30	1
17	917.1340	1/2" Hexagonal socket, 8 mm	1	37	911.1310	1/2" Bit socket hexagon, short, 10 mm	1	58	911.1375	1/2" Bit socket Torx tamperproof, TB40	1
18	917.1341	1/2" Hexagonal socket, 9 mm	1	38	911.1312	1/2" Bit socket hexagon, short, 12 mm	1	59	911.1376	1/2" Bit socket Torx tamperproof, TB45	1
19	917.1210	1/2" Hexagonal socket, 10 mm	1	39	911.1314	1/2" Bit socket hexagon, short, 14 mm	1	60	911.1377	1/2" Bit socket Torx tamperproof, TB50	1
20	917.1211	1/2" Hexagonal socket, 11 mm	1	40	911.4333	1/2" Torx E Socket, E10	1	61	911.1378	1/2" Bit socket Torx tamperproof, TB55	1
21	917.1212	1/2" Hexagonal socket, 12 mm	1	41	911.4334	1/2" Torx E Socket, E11	1	62	911.1379	1/2" Bit socket Torx tamperproof, TB60	1
22	917.1222	1/2" Hexagonal socket, 22 mm	1	42	911.4335	1/2" Torx E Socket, E12	1	63	911.1380	1/2" Bit socket Torx tamperproof, TB70	1

813.0068

L Screw spanner set



Pos.	Code	Description	pcs	Pos.	Code	Description	pcs	Pos.	Code	Description	pcs
1	517.0718	Double open ended spanners, 30 x 32 mm	1	13	518.0856	CHROMEplus Starter and block spanner, 14 x 17 mm	1	20	518.0010	CHROMEplus Combination spanner, stubby, 10 mm	1
2	517.0737	Double open ended spanners, 25 x 28 mm	1	14	518.0853	CHROMEplus Starter and block spanner, 11 x 13 mm	1	21	518.0011	CHROMEplus Combination spanner, stubby, 11 mm	1
3	517.0716	Double open ended spanners, 24 x 27 mm	1	15	518.0852	CHROMEplus Starter and block spanner, 10 x 12 mm	1	22	518.0012	CHROMEplus Combination spanner, stubby, 12 mm	1
4	517.0715	Double open ended spanners, 21 x 23 mm	1	16	151.4530	Ball ended Torx key wrench set, extra long and bent 108°, 9 pcs	9	23	518.0013	CHROMEplus Combination spanner, stubby, 13 mm	1
5	517.0714	Double open ended spanners, 20 x 22 mm	1	17	151.4420	Ball ended hexagon key wrench set, extra long, 9 pcs	9	24	518.0014	CHROMEplus Combination spanner, stubby, 14 mm	1
6	517.0712	Double open ended spanners, 18 x 19 mm	1	18	518.0007	CHROMEplus Combination spanner, stubby, 8 mm	1	25	518.0015	CHROMEplus Combination spanner, stubby, 15 mm	1
7	517.0710	Double open ended spanners, 16 x 17 mm	1	19	518.0008	CHROMEplus Combination spanner, stubby, 9 mm	1	26	518.0016	CHROMEplus Combination spanner, stubby, 16 mm	1
8	517.0709	Double open ended spanners, 14 x 15 mm	1								
9	517.0707	Double open ended spanners, 12 x 13 mm	1								
10	517.0704	Double open ended spanners, 10 x 11 mm	1								
11	517.0702	Double open ended spanners, 8 x 9 mm	1								
12	517.0701	Double open ended spanners, 6 x 7 mm	1								

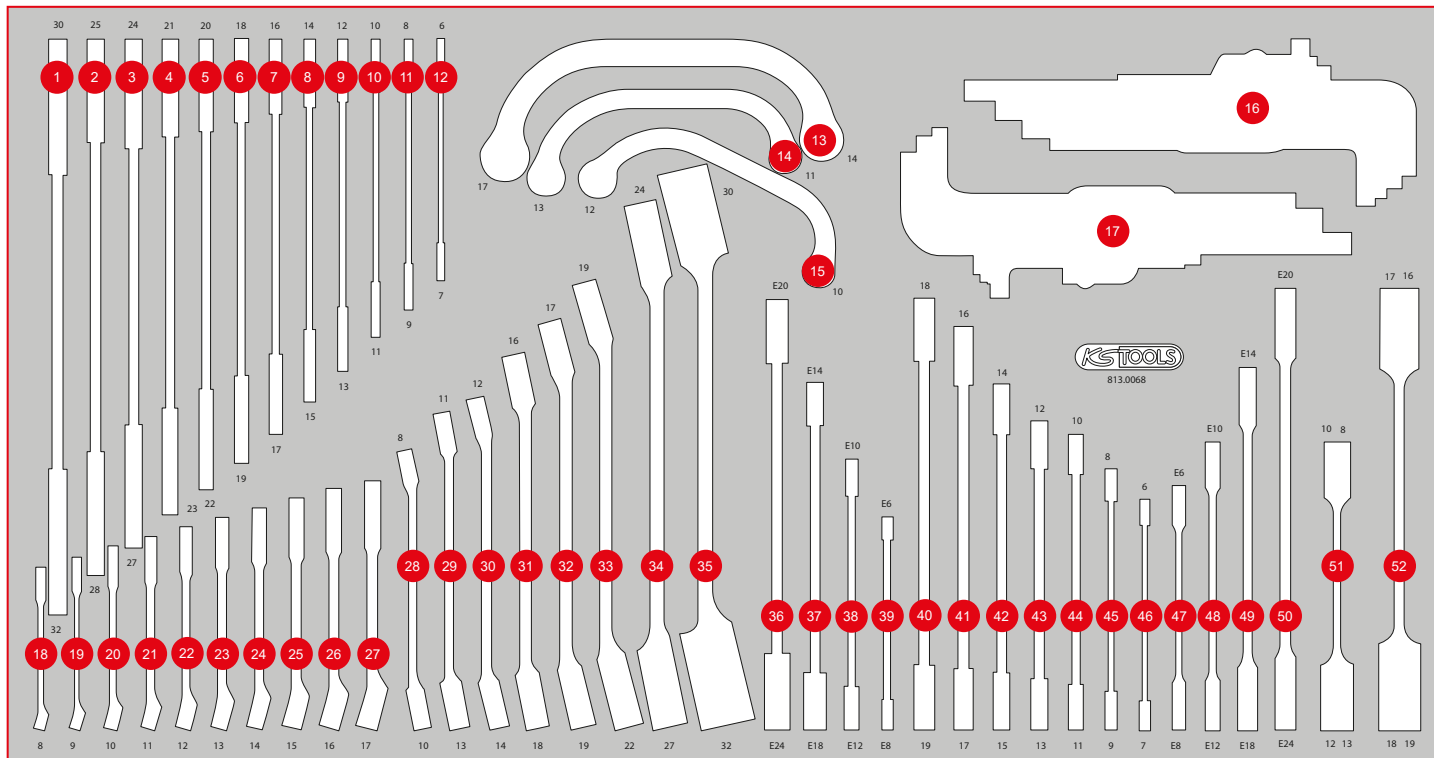

Pos.	Code	Description	pcs	Pos.	Code	Description	pcs	Pos.	Code	Description	pcs
27	518.0017	CHROMEplus Combination spanner, stubby, 17 mm	1	38	911.0373	Double ring spanner for Torx E profile, E10 x E12	1	46	920.0406	ULTIMATEplus Double ring ended spanner, 6 x 7 mm	1
28	517.0252	Open double ring spanner, offset, 8 x 10 mm	1	39	911.0371	Double ring spanner for Torx E profile, E6 x E8	1	47	503.4351	GEARplus Double ring ratchet spanner, E6 x E8	1
29	517.9244	Open double ring spanner, offset, 11 x 13 mm	1	40	920.0418	ULTIMATEplus Double ring ended spanner, 18 x 19 mm	1	48	503.4353	GEARplus Double ring ratchet spanner, E10 x E12	1
30	517.0258	Open double ring spanner, offset, 12 x 14 mm	1	41	920.0416	ULTIMATEplus Double ring ended spanner, 16 x 17 mm	1	49	503.4355	GEARplus Double ring ratchet spanner, E14 x E18	1
31	517.0263	Open double ring spanner, offset, 16 x 18 mm	1	42	920.0414	ULTIMATEplus Double ring ended spanner, 14 x 15 mm	1	50	503.4357	GEARplus Double ring ratchet spanner, E20 x E24	1
32	517.0264	Open double ring spanner, offset, 17 x 19 mm	1	43	920.0412	ULTIMATEplus Double ring ended spanner, 12 x 13 mm	1	51	503.4656	4 in 1 GEARplus reversing double ratchet ring spanner, 8 x 10 x 12 x 13 mm	1
33	517.0266	Open double ring spanner, offset, 19 x 22 mm	1	44	920.0410	ULTIMATEplus Double ring ended spanner, 10 x 11 mm	1	52	503.4546	4 in 1 GEARplus reversing double ratchet ring spanner, 16 x 17 x 18 x 19 mm	1
34	517.0268	Open double ring spanner, offset, 24 x 27 mm	1	45	920.0408	ULTIMATEplus Double ring ended spanner, 8 x 9 mm	1				
35	517.0269	Open double ring spanner, offset, 30 x 32 mm	1								
36	911.0376	Double ring spanner for Torx E profile, E20 x E24	1								
37	911.0374	Double ring spanner for Torx E profile, E14 x E18	1								

813.0028

L T-handle angle spanner and file set

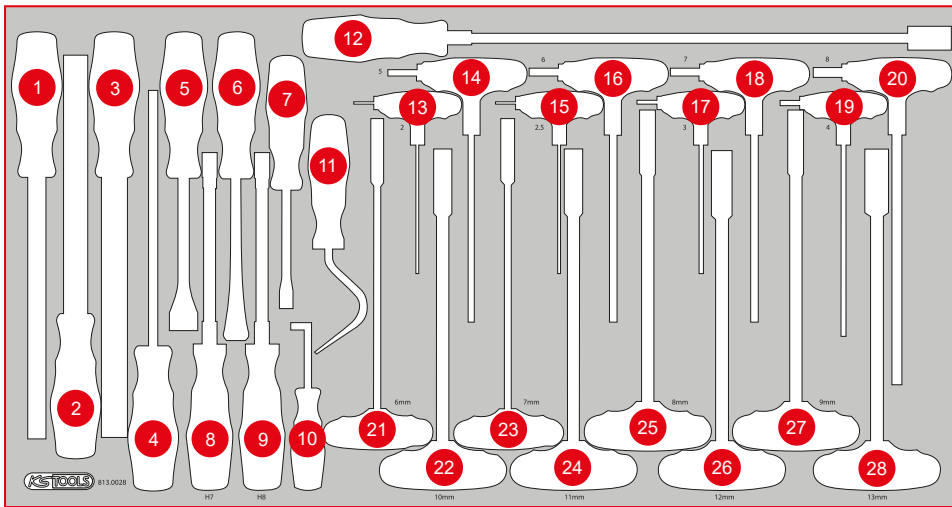

Pos.	Code	Description	pcs
1	157.0405	Tri-bastard file, form C, cut 2, 200 mm	1
2	157.0105	Halfround file, form E, cut 2, 20 mm	1
3	157.0005	Flat file, form B, cut 2, 200 mm	1
4	157.0205	Round file, form F, cut 2, 200 mm	1
5	140.2615	Clip remover, short 9 mm	1
6	140.2616	Clip remover, short 7,5 mm	1
7	140.2371	Clip remover short, Length 245 mm, Opening 4 mm	1
8	159.1127	ERGOTORQUEplus Socket screwdriver, 7 mm	1
9	159.2128	ERGOTORQUEplus Socket screwdriver, 8 mm	1
10	550.1048	Hook, 90° offset	1
11	550.1073	Hook, large, sickle	1
12	550.1025	Flexible magnet lifter, 510 mm, Øhead=15 mm	1
13	151.8130	T-handle ball ended hexagon key wrench, 2 mm	1
14	151.8134	T-handle ball ended hexagon key wrench, 5 mm	1
15	151.8131	T-handle ball ended hexagon key wrench, 2,5 mm	1
16	151.8135	T-handle ball ended hexagon key wrench, 6 mm	1
17	151.8132	T-handle ball ended hexagon key wrench, 3 mm	1
18	151.8136	T-handle ball ended hexagon key wrench, 7 mm	1
19	151.8133	T-handle ball ended hexagon key wrench, 4 mm	1
20	151.8137	T-handle ball ended hexagon key wrench, 8 mm	1
21	158.5006	T-handle socket screwdriver, long, 6 mm	1
22	158.5010	T-handle socket screwdriver, long, 10 mm	1
23	158.5007	T-handle socket screwdriver, long, 7 mm	1
24	158.5011	T-handle socket screwdriver, long, 11 mm	1
25	158.5008	T-handle socket screwdriver, long, 8 mm	1
26	158.5012	T-handle socket screwdriver, long, 12 mm	1
27	158.5009	T-handle socket screwdriver, long, 9 mm	1
28	158.5013	T-handle socket screwdriver, long, 13 mm	1

813.0036

L Pliers and measuring tool set

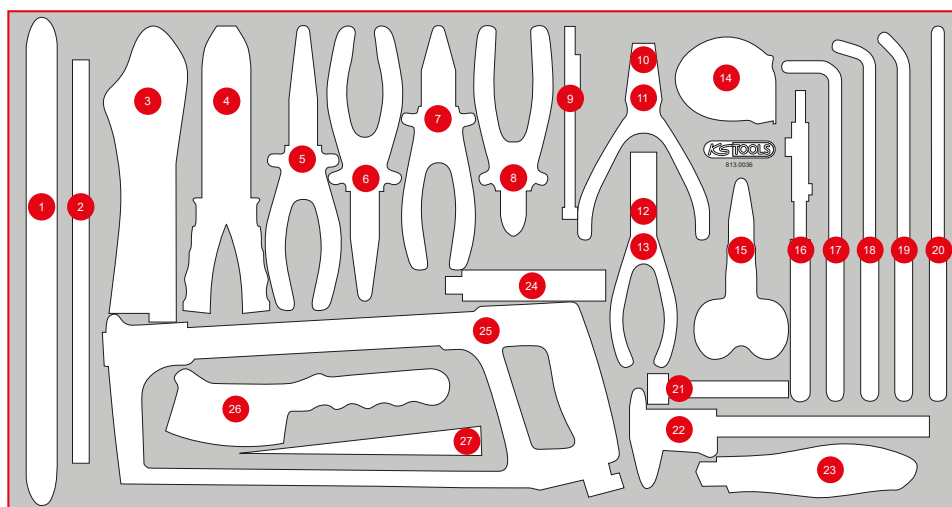

Pos.	Code	Description	pcs
1	911.8146	Tyre lever, 370 mm	1
2	300.0104	Flexible steel rule, 300 mm	1
3	115.1033	Self grip wrench, 220 mm	1
4	115.1231	Multifunction pliers for insulated and non insulated cable terminals, 220 mm	1
5	115.1024	ERGOTORQUE long nose pliers serrated cutter, 200 mm	1
6	115.1019	ERGOTORQUE bent nose pliers serrated, 210 mm	1
7	115.1021	ERGOTORQUE combination pliers, 180 mm	1
8	115.1012	ERGOTORQUE diagonal side cutter, 160 mm	1
9	550.1001	2 in 1 Telescopic solenoid holder with washer jet cleaning and setting tool, 150 - 675 mm	1
10	500.1026	Circlip pliers for external circlips, angled, 160 mm	1
11	500.1029	Circlip pliers for external circlips, 160 mm	1
12	500.1032	Circlip pliers for internal circlips, angled, 160 mm	1
13	500.1035	Circlip pliers for internal circlips, 160 mm	1
14	300.0114	Tape measure with locking device and belt clip, black red, 5m, 19 mm	1
15	118.0013	Uni workshop scissors, 143 mm	1
16	115.2010	Water pump pliers, 240 mm	1
17	500.7053	Telephone pliers 90° curved, extra long, 270 mm	1
18	500.7047	Sparkplug plier 12 mm	1
19	500.7052	Telephone pliers 45° curved, extra long, 270 mm	1
20	500.7051	Telephone pliers, extra long, 270 mm	1
21	300.0600	Feeler gauge, 20 Blades, 0,05 - 1 mm	1
22	300.0510	Pocket vernier calliper 0 - 150 mm, 235 mm	1
23	907.2135	Universal snap off blade knife 18 mm	1
24	907.2166	Snap off blades 0,5 x 1,8 x 100 mm, dispenser with 10 pieces	10
25	907.2102	Hacksaw frame, 300 mm, with two component handle	1
26	201.2335	Steel wire brake saddle brush, 2-row, straight 225 mm	1
27	911.8138	Trim plastic wedge, 195 mm x B = 30 mm	1

813.0040

L Hammer, chisel and impact socket set

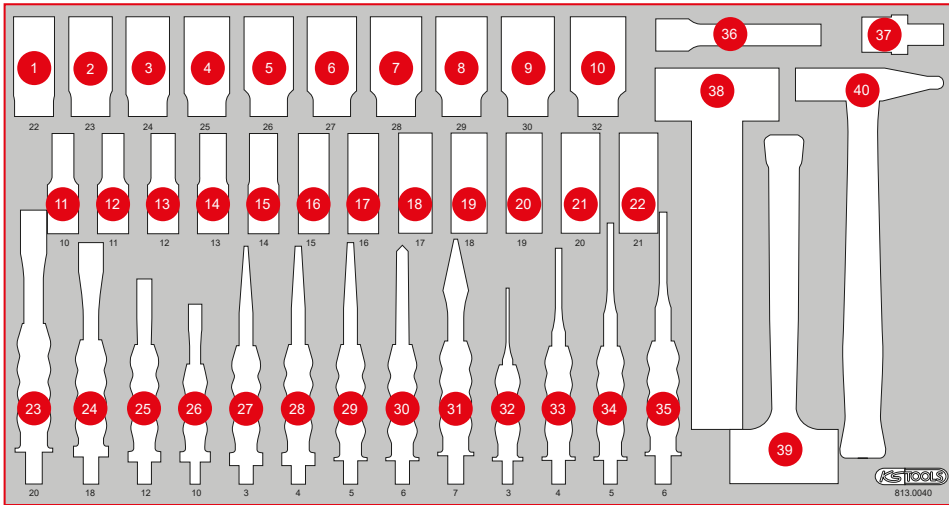

Pos.	Code	Description	pcs
1	515.1122	1/2" Hexagon impact socket, deep, 22 mm	1
2	515.1123	1/2" Hexagon impact socket, deep, 23 mm	1
3	515.1124	1/2" Hexagon impact socket, deep, 24 mm	1
4	515.1125	1/2" Hexagon impact socket, deep, 25 mm	1
5	515.1126	1/2" Hexagon impact socket, deep, 26 mm	1
6	515.1127	1/2" Hexagon impact socket, deep, 27 mm	1
7	515.1128	1/2" Hexagon impact socket, deep, 28 mm	1
8	515.1129	1/2" Hexagon impact socket, deep, 29 mm	1
9	515.1130	1/2" Hexagon impact socket, deep, 30 mm	1
10	515.1132	1/2" Hexagon impact socket, deep, 32 mm	1
11	515.1110	1/2" Hexagon impact socket, deep, 10 mm	1
12	515.1111	1/2" Hexagon impact socket, deep, 11 mm	1
13	515.1112	1/2" Hexagon impact socket, deep, 12 mm	1
14	515.1113	1/2" Hexagon impact socket, deep, 13 mm	1
15	515.1114	1/2" Hexagon impact socket, deep, 14 mm	1
16	515.1115	1/2" Hexagon impact socket, deep, 15 mm	1
17	515.1116	1/2" Hexagon impact socket, deep, 16 mm	1
18	515.1117	1/2" Hexagon impact socket, deep, 17 mm	1
19	515.1118	1/2" Hexagon impact socket, deep, 18 mm	1
20	515.1119	1/2" Hexagon impact socket, deep, 19 mm	1
21	515.1120	1/2" Hexagon impact socket, deep, 20 mm	1
22	515.1121	1/2" Hexagon impact socket, deep, 21 mm	1
23	156.0241	Flat chisel, octagon, 20 mm	1
24	156.0254	Flat chisel, octagon, 18 mm	1
25	156.0252	Flat chisel, octagon, 12 mm	1
26	156.0251	Flat chisel, octagon, 10 mm	1
27	156.0237	Punch, Ø 3 mm, conical	1
28	156.0238	Punch, Ø 4 mm, conical	1
29	156.0244	Punch, Ø 5 mm, conical	1
30	156.0243	Centre punch, octagon 10 mm	1
31	156.0242	Cross chisel, octagon, 7 mm	1
32	156.0231	Pin punch, Ø 3 mm, cylindrical shaft	1
33	156.0232	Pin punch, Ø 4 mm, cylindrical shaft	1
34	156.0233	Pin punch, Ø 5 mm, cylindrical shaft	1
35	156.0234	Pin punch, Ø 6 mm, cylindrical shaft	1
36	515.1135	1/2" Impact extension, 125 mm	1
37	515.1133	1/2" Impact universal ball joint	1
38	142.5101	Club Hammer, fibreglas handle, 1000 g	1
39	140.5252	Recoil free soft faced Hammer, 400 g	1
40	142.1402	Fitters Hammer, fibreglas handle, 400 g	1

P25

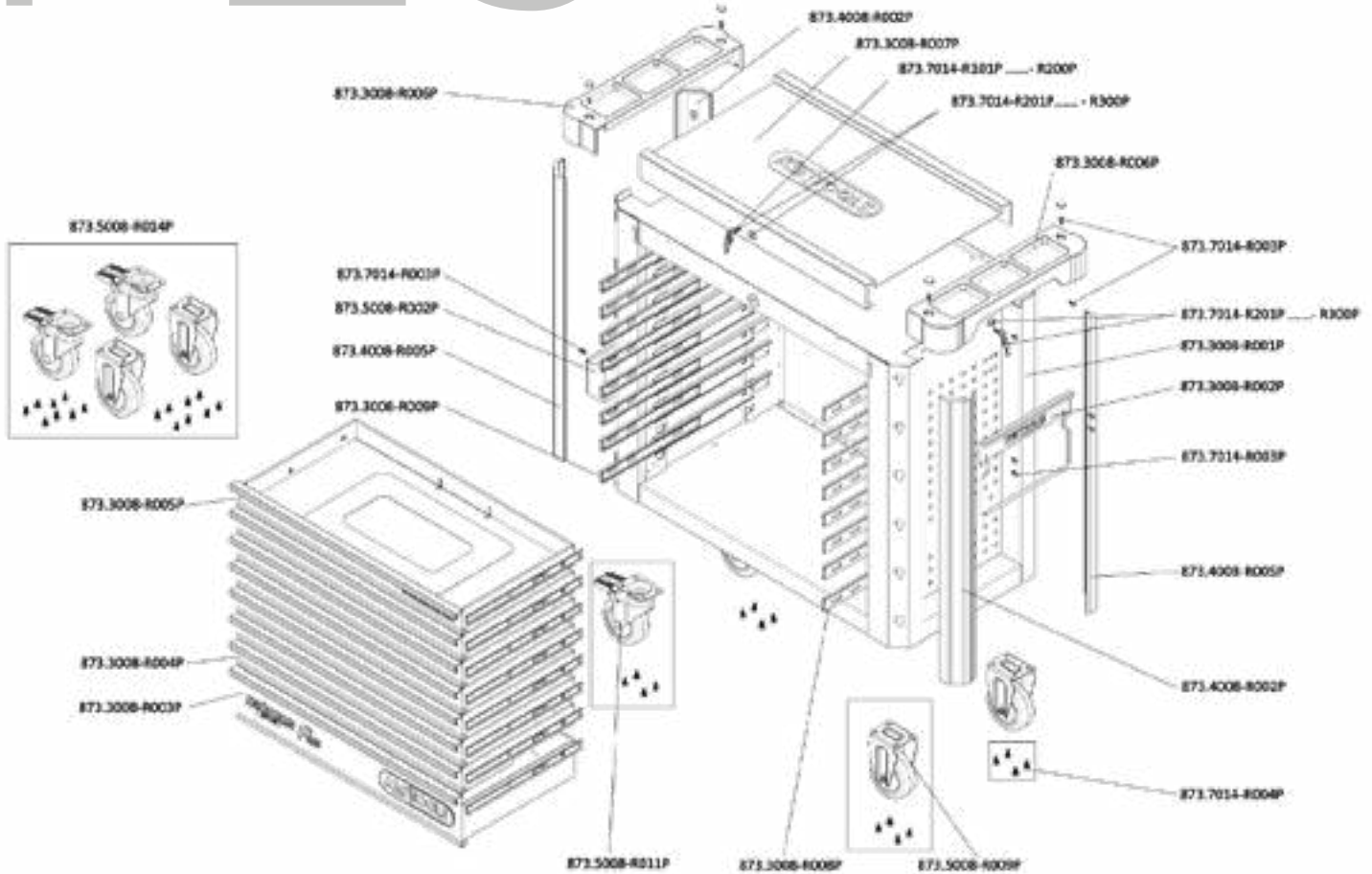

INDIVIDUAL PARTS LIST

Art.-Nr.	Description	amount
873.7014-R101P...	Replacement key for PERFORMANCEplus workshop trolley lock number xyz	2
873.7014-R201P...	Lock with 2 keys for PERFORMANCEplus workshop trolley lock number xyz	2
873.3008-R001P	Body with handle	1
873.3008-R002P	Paper roll holder for PERFORMANCEplus workshop trolley P10/P15/P25	1
873.3008-R003P	Compartment with logo and ball-bearing guide, 755x398x145 mm	1
873.3008-R004P	Compartment with ball-bearing guide, 755x398x65 mm	6
873.3008-R005P	Compartment with website and ball-bearing guide, 755x398x65 mm	1
873.3008-R006P	Storage for work surface	2
873.3008-R007P	Stainless steel work surface	1
873.3008-R008P	Full extension (with ball-bearing guide) with automatic retraction	8
873.3008-R009P	Full extension (with ball-bearing guide) with automatic retraction	8
873.4008-R002P	Plastic bumpers	2
873.4008-R005P	Plastic bumpers	2
873.5008-R002P	Can holder for PERFORMANCEplus workshop trolley P10/P15/P25/P35	1
873.5008-R009P	Fixed castors for PERFORMANCEplus workshop trolley, incl. screws	2
873.5008-R011P	Swivel castors with brakes, for PERFORMANCEplus workshop trolley, incl. screws	2
873.5008-R014P	Roller set for PERFORMANCEplus workshop trolley, incl. screws	1
873.7014-R003P	M6x12 screw (1 pcs.) for PERFORMANCEplus workshop trolley accessories	14
873.7014-R004P	M8 screws for PERFORMANCEplus workshop trolley rollers (16 pcs.)	1



873.7014-R101P...R200P
Replacement key for lock number xyz



873.7014-R201P...R300P
Lock with 2 keys, lock number xyz



873.3008-R008P
Full extension (with ball-bearing guide) with automatic retraction, right



873.3008-R009P
Full extension with self-closing, for drawer, left



873.5008-R009P
Fixed castors, incl. screws



873.5008-R011P
Swivel castors with brakes, incl. screws

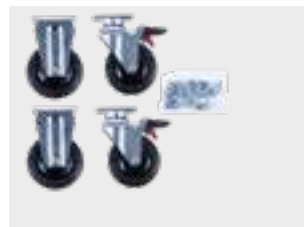

873.5008-R014P
Roller set, incl. screws



873.3008-R007P
Stainless steel work surface



873.3008-R006P
Storage for work surface, including screw cover, usable on both sides



873.3008-R005P
Compartment with website and ball-bearing guide, 755x398x65 mm



873.3008-R004P
Compartment with ball-bearing guide, 755x398x65 mm



873.3008-R003P
Compartment with logo and ball-bearing guide, 755x398x145 mm



873.5008-R002P
Can holder including screws, W = 310 mm



873.3008-R002P
Paper roll holder including screws, W= 320 mm



873.4008-R005P
Plastic bumpers, front left, back right



873.4008-R002P
Plastic bumpers, front right, back left



873.7014-R004P
M8 screws (16 pcs.)



873.7014-R003P
M6x12 screw (1 pcs.)



873.3008-R001P
Body of workshop trolley attachment



Enough spares for
your treasure!