

P35

workshop tool trolley
with 549 tools for 12 drawers
835.12549

INNOVATIVE THINKING FOR GREATER EFFICIENCY!



Workshop trolley P35
with 12 compartments
873.5008



DUO Lock Brilliant locking system



Twelve drawers each load capacity up to 50 kg



Stable **ball bearing**



Stainless steel surface

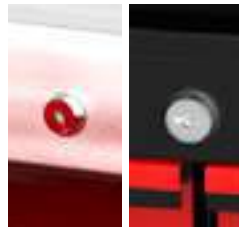

Two locks lockable



Anti-static castors with brakes



Integrated **corner protection**



Paper roll holder included



Can holder included

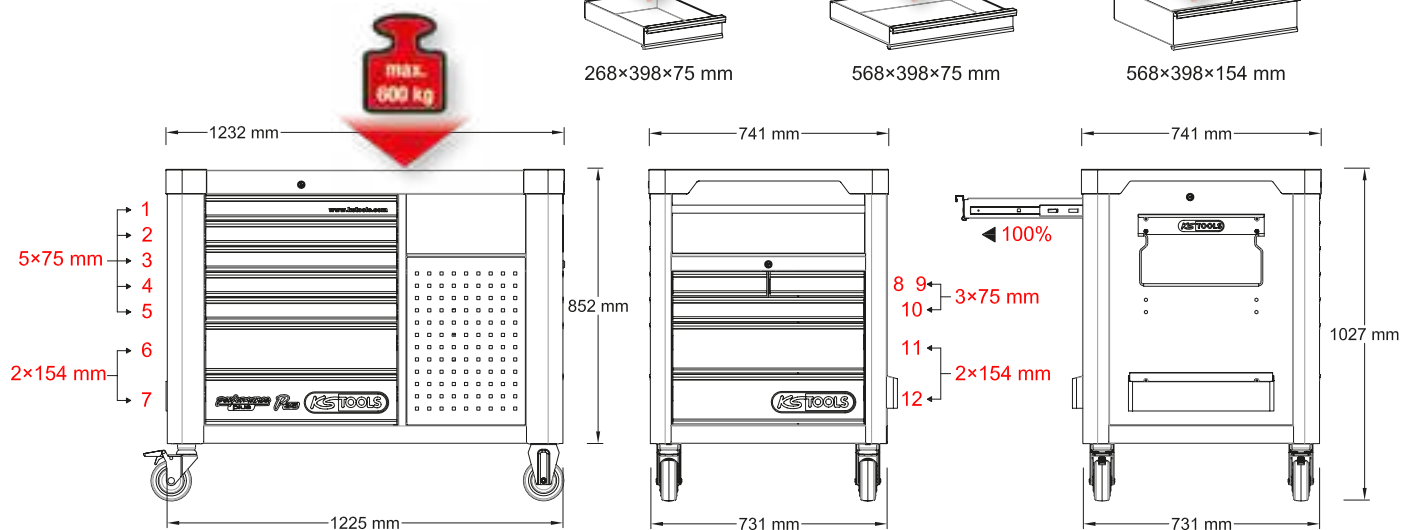
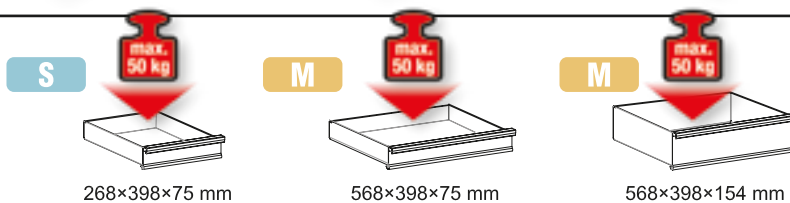

P35 workshop tool trolley set with 549 tools for 12 drawers

835.12549

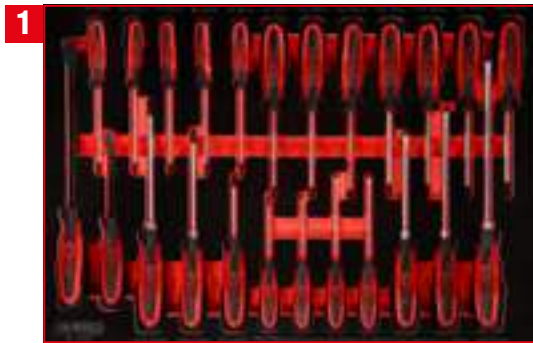

Screwdriver set in foam insert

811.0024

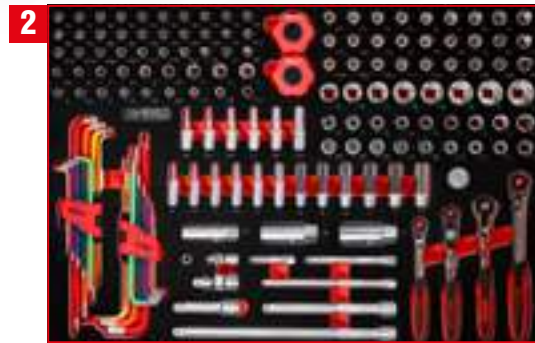

1/4" + 3/8" socket spanner set in foam insert

811.0156

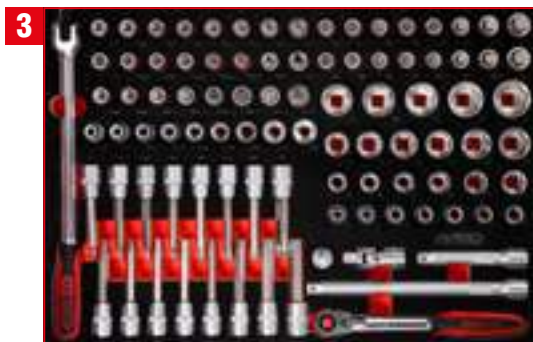

1/2" socket spanner set in foam insert

811.0095



Combination spanner set in foam insert

811.0030



Screw spanner set in foam insert

811.0051

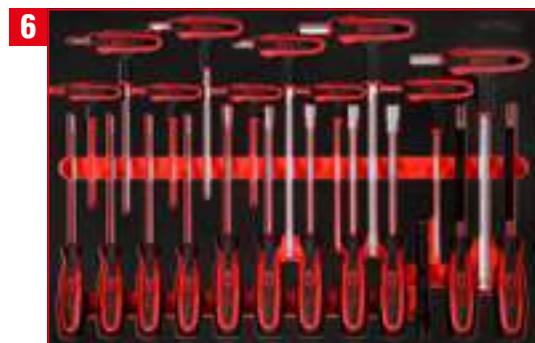

T-handle and screwdriver set in foam insert

811.1022

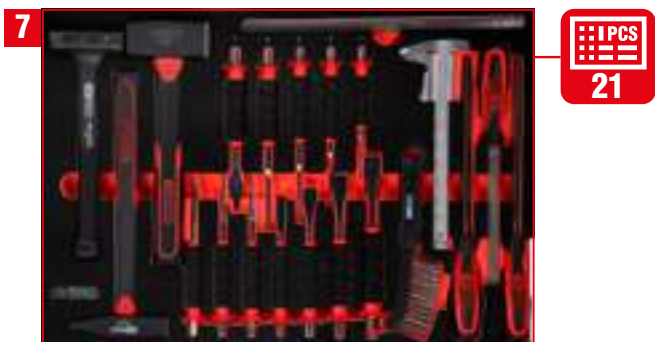

Hammer, chisel and file set in foam insert

811.0021



Spanner set in foam insert

812.0005



Spanner set in foam insert

812.0007



3/8" + 1/2" socket spanner set in foam insert

811.0073



3/4" socket spanner set in foam insert

811.0032



3/4" impact socket set in foam insert

811.1033

M Screwdriver set

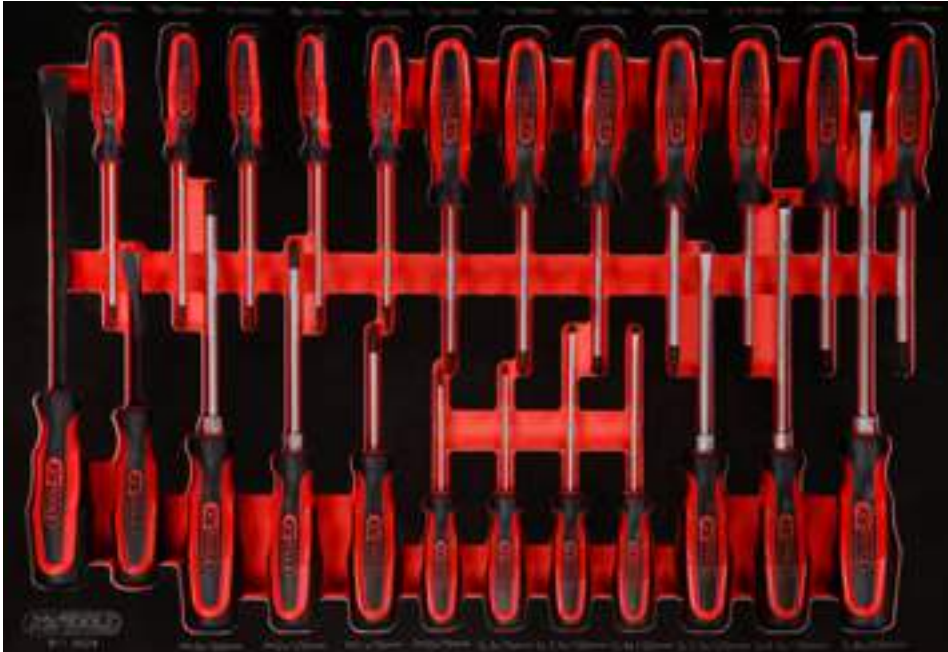
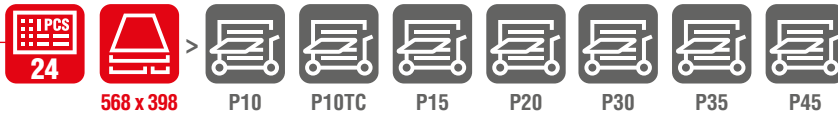

Pos.	Code	Description	pcs
1	911.8102	Pry bar, 15 x 185 mm	1
2	911.8101	Pry bar, 11 x 115 mm	1
3	159.1133	ERGOTORQUEplus screwdriver, Torx, T5	1
4	159.1134	ERGOTORQUEplus screwdriver, Torx, T6	1
5	159.1135	ERGOTORQUEplus screwdriver, Torx, T7	1
6	159.1030	ERGOTORQUEplus screwdriver, Torx, T8	1
7	159.1031	ERGOTORQUEplus screwdriver, Torx, T9	1
8	159.1032	ERGOTORQUEplus screwdriver, Torx, T10	1
9	159.1033	ERGOTORQUEplus screwdriver, Torx, T15	1
10	159.1034	ERGOTORQUEplus screwdriver, Torx, T20	1
11	159.1035	ERGOTORQUEplus screwdriver, Torx, T25	1
12	159.1036	ERGOTORQUEplus screwdriver, Torx, T27	1
13	159.1037	ERGOTORQUEplus screwdriver, Torx, T30	1
14	159.1038	ERGOTORQUEplus screwdriver, Torx, T40	1
15	159.1024	ERGOTORQUEplus screwdriver, Torx, PH3, 265 mm	1
16	159.1022	ERGOTORQUEplus screwdriver, Torx, PH2, 230 mm	1
17	159.1020	ERGOTORQUEplus screwdriver, Torx, PH1, 180 mm	1
18	159.1027	ERGOTORQUEplus screwdriver, Torx, PH0, 155 mm	1
19	159.1002	ERGOTORQUEplus screwdriver for slotted screws, 3 mm, 155 mm	1
20	159.1112	ERGOTORQUEplus screwdriver for slotted screws, 3,5 mm, 180 mm	1
21	159.1004	ERGOTORQUEplus screwdriver for slotted screws, 4 mm, 180 mm	1
22	159.1006	ERGOTORQUEplus screwdriver for slotted screws, 5,5 mm, 230 mm	1
23	159.1009	ERGOTORQUEplus screwdriver for slotted screws, 6,5 mm, 255 mm	1
24	159.1011	ERGOTORQUEplus screwdriver for slotted screws, 8 mm, 315 mm	1

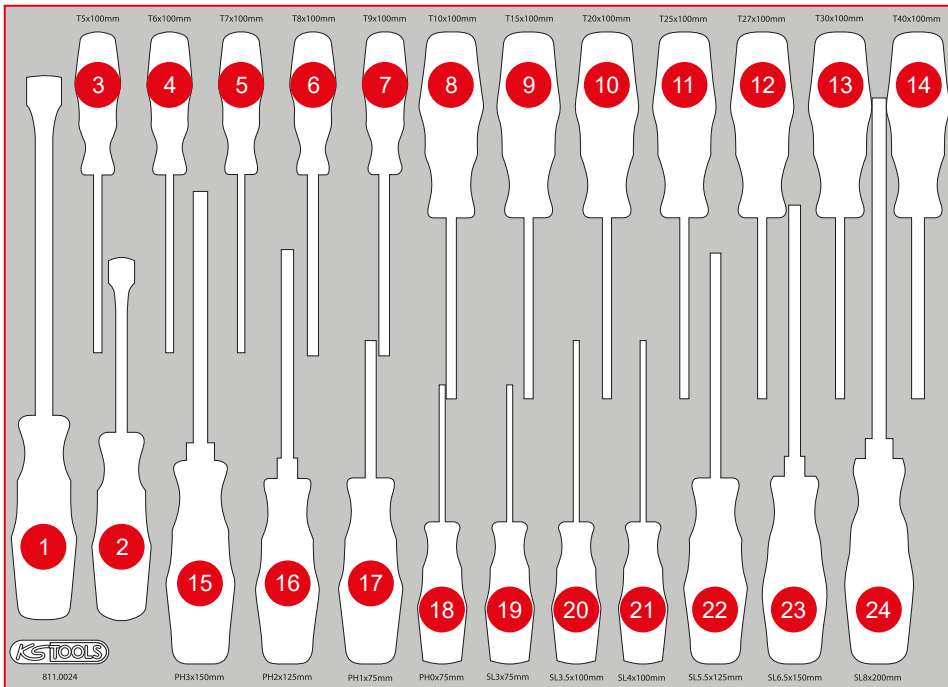

M 1/4" + 3/8" socket spanner set

568 x 398



P10



P10TC



P15



P20



P30



P35



P45

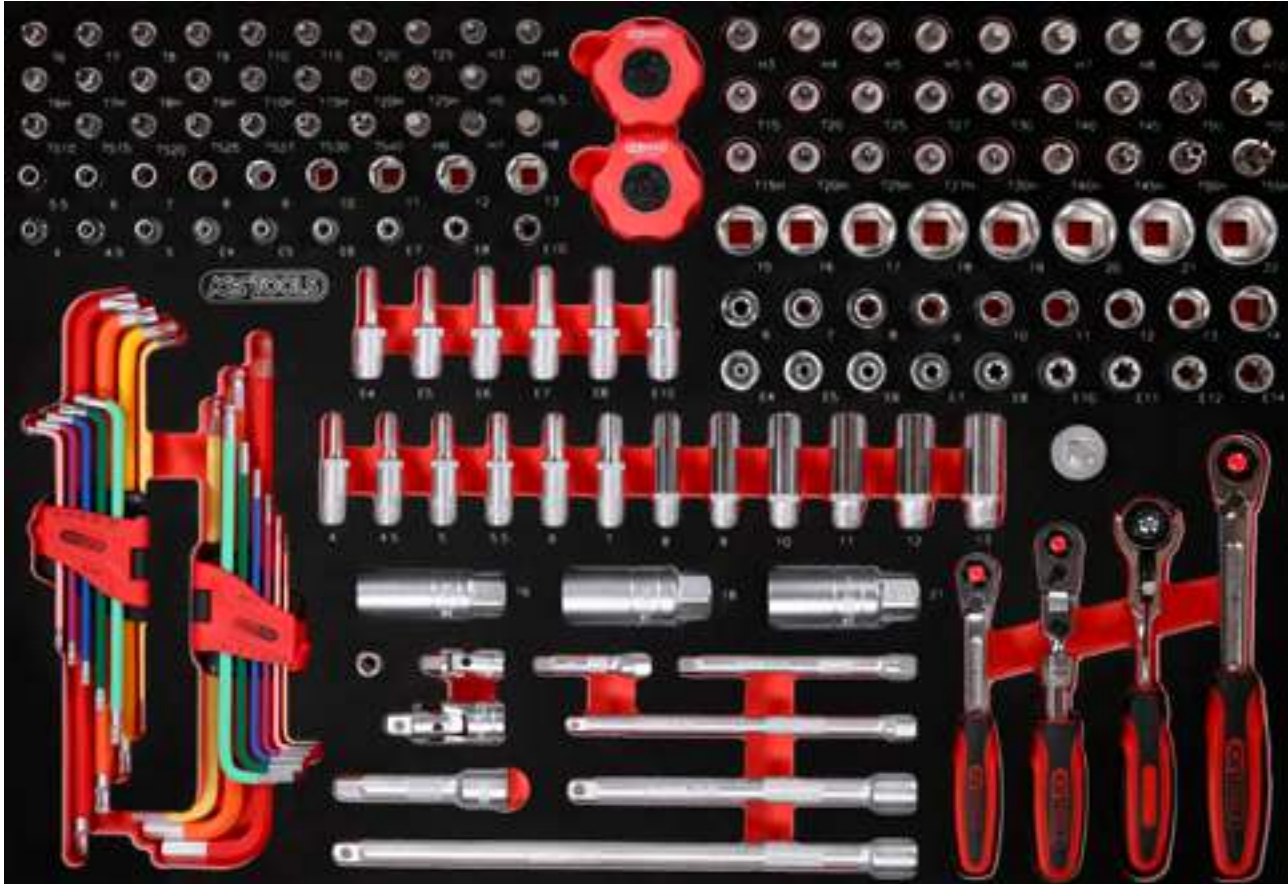

Pos.	Code	Description	pcs	Pos.	Code	Description	pcs	Pos.	Code	Description	pcs
1	920.3890	3/8" SlimPOWER Reversible ratchet, 72 teeth	1	22	917.1527	1/4" Hexagonal socket, deep, 5 mm	1	46	917.1410	1/4" Hexagonal socket, 10 mm	1
2	914.1405	1/4" MODIFIX mini T-handle swivel head ratchet, 72 teeth	1	23	917.1528	1/4" Hexagonal socket, deep, 5,5 mm	1	47	917.1411	1/4" Hexagonal socket, 11 mm	1
3	914.1420	1/4" SlimPOWER telescopic-joint reversible ratchet, 72 teeth	1	24	917.1426	1/4" Hexagonal socket, deep, 6 mm	1	48	917.1412	1/4" Hexagonal socket, 12 mm	1
4	920.1490	1/4" SlimPOWER Reversible ratchet, 72 teeth	1	25	917.1427	1/4" Hexagonal socket, deep, 7 mm	1	49	917.1413	1/4" Hexagonal socket, 13 mm	1
5	911.1423	1/4" Extension with hexagon drive, 50 mm	1	26	917.1428	1/4" Hexagonal socket, deep, 8 mm	1	50	911.4313	1/4" Torx E Socket, E4	1
6	911.1424	1/4" Extension with hexagon drive, 100 mm	1	27	917.1429	1/4" Hexagonal socket, deep, 9 mm	1	51	911.4314	1/4" Torx E Socket, E5	1
7	911.1451	1/4" Extension with hexagon drive, 150 mm	1	28	917.1430	1/4" Hexagonal socket, deep, 10 mm	1	52	911.4315	1/4" Torx E Socket, E6	1
8	911.3801	3/8" Extension with knurling, 75 mm	1	29	917.1431	1/4" Hexagonal socket, deep, 11 mm	1	53	911.4316	1/4" Torx E Socket, E7	1
9	911.3802	3/8" Extension with knurling, 150 mm	1	30	917.1432	1/4" Hexagonal socket, deep, 12 mm	1	54	911.4317	1/4" Torx E Socket, E8	1
10	911.3803	3/8" Extension with knurling, 250 mm	1	31	917.1433	1/4" Hexagonal socket, deep, 13 mm	1	55	911.4332	1/4" Torx E Socket, E10	1
11	911.1450	1/4" Universal joint	1	32	917.2401	1/4" Torx E Socket, deep, E4	1	56	911.4407	1/4" Bit socket Torx, T6	1
12	911.3850	3/8" Universal joint	1	33	917.2402	1/4" Torx E Socket, deep, E5	1	57	911.4362	1/4" Bit socket Torx, T7	1
13	911.0101	1/4" socket with magnet	1	34	917.2403	1/4" Torx E Socket, deep, E6	1	58	911.1448	1/4" Bit socket Torx, T8	1
14	911.3804	3/8" Spark plug socket, 16 mm	1	35	917.2404	1/4" Torx E Socket, deep, E7	1	59	911.1478	1/4" Bit socket Torx, T9	1
15	911.3823	3/8" Spark plug socket, 18 mm	1	36	917.2405	1/4" Torx E Socket, deep, E8	1	60	911.1442	1/4" Bit socket Torx, T10	1
16	911.3805	3/8" Spark plug socket, 21 mm	1	37	917.2406	1/4" Torx E Socket, deep, E10	1	61	911.1443	1/4" Bit socket Torx, T15	1
17	911.3826	3/8" Sliding / reducing adaptor, 1/2"F x 3/8"M	1	38	917.1404	1/4" Hexagonal socket, 4 mm	1	62	911.1444	1/4" Bit socket Torx, T20	1
18	151.4530	Ball ended Torx key wrench set, extra long and bent 108°, 9 pcs	9	39	917.14045	1/4" Hexagonal socket, 4,5 mm	1	63	911.1445	1/4" Bit socket Torx, T25	1
19	151.4420	Ball ended hexagon key wrench set, extra long, 9 pcs	9	40	917.1405	1/4" Hexagonal socket, 5 mm	1	64	917.1456	1/4" Bit socket Torx tamperproof, TB6	1
20	917.1525	1/4" Hexagonal socket, deep, 4 mm	1	41	917.14055	1/4" Hexagonal socket, 5,5 mm	1	65	917.1457	1/4" Bit socket Torx tamperproof, TB7	1
21	917.1526	1/4" Hexagonal socket, deep, 4,5 mm	1	42	917.1406	1/4" Hexagonal socket, 6 mm	1	66	911.1461	1/4" Bit socket Torx tamperproof, TB8	1
				43	917.1407	1/4" Hexagonal socket, 7 mm	1	67	911.1485	1/4" Bit socket Torx tamperproof, TB9	1
				44	917.1408	1/4" Hexagonal socket, 8 mm	1	68	911.1462	1/4" Bit socket Torx tamperproof, TB10	1
				45	917.1409	1/4" Hexagonal socket, 9 mm	1	69	911.1463	1/4" Bit socket Torx tamperproof, TB15	1

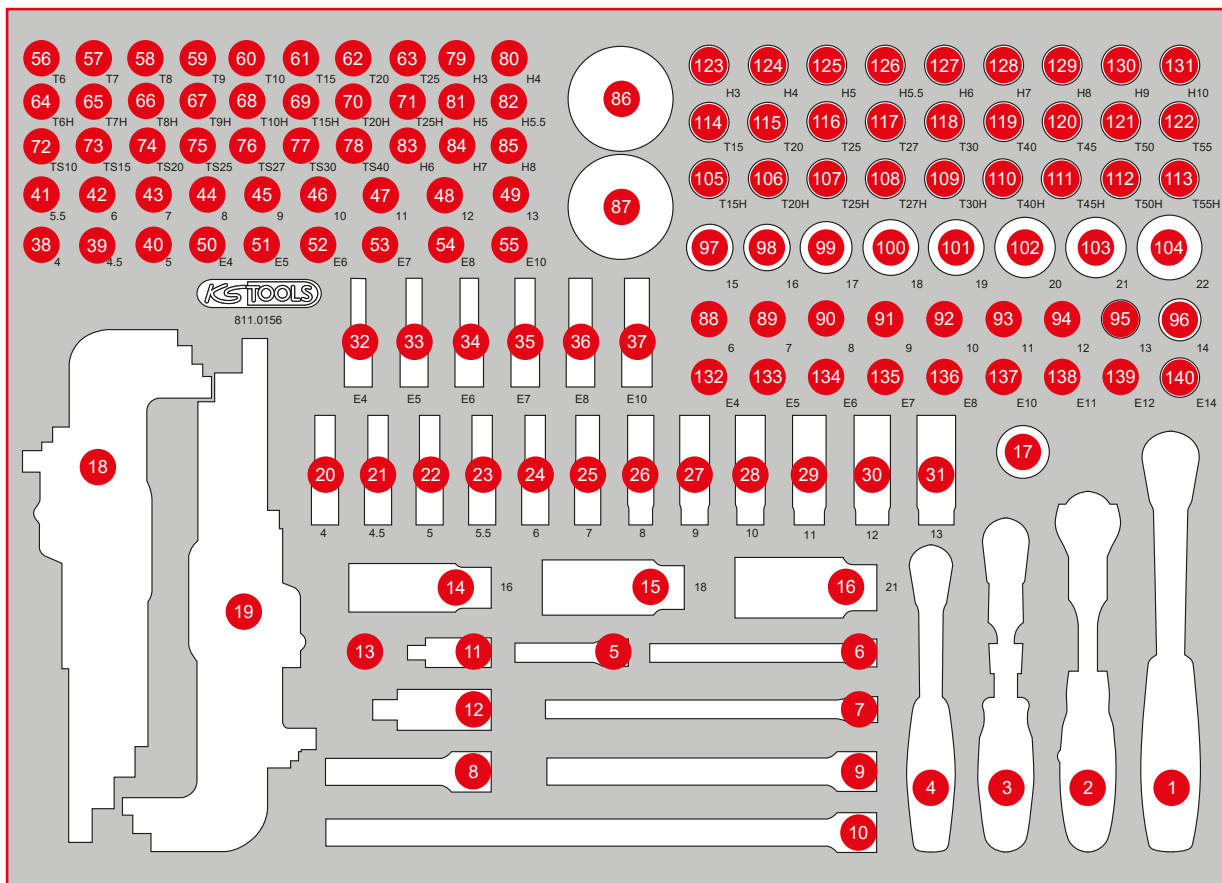

Pos.	Code	Description	pcs	Pos.	Code	Description	pcs	Pos.	Code	Description	pcs
70	911.1464	1/4" Bit socket Torx tamperproof, TB20	1	94	917.3812	3/8" Hexagonal socket, 12 mm	1	118	911.3873	3/8" Bit socket Torx, T30	1
71	911.1465	1/4" Bit socket Torx tamperproof, TB25	1	95	917.3813	3/8" Hexagonal socket, 13 mm	1	119	911.3874	3/8" Bit socket Torx, T40	1
72	911.1701	1/4" Bit socket five star tamperproof, TS10	1	96	917.3814	3/8" Hexagonal socket, 14 mm	1	120	911.3885	3/8" Bit socket Torx, T45	1
73	911.1702	1/4" Bit socket five star tamperproof, TS15	1	97	917.3815	3/8" Hexagonal socket, 15 mm	1	121	911.3884	3/8" Bit socket Torx, T50	1
74	911.1703	1/4" Bit socket five star tamperproof, TS20	1	98	917.3816	3/8" Hexagonal socket, 16 mm	1	122	911.3888	3/8" Bit socket Torx, T55	1
75	911.1704	1/4" Bit socket five star tamperproof, TS25	1	99	917.3817	3/8" Hexagonal socket, 17 mm	1	123	911.3863	3/8" Bit socket hexagon, 3 mm	1
76	911.1705	1/4" Bit socket five star tamperproof, TS27	1	100	917.3818	3/8" Hexagonal socket, 18 mm	1	124	911.3864	3/8" Bit socket hexagon, 4 mm	1
77	911.1706	1/4" Bit socket five star tamperproof, TS30	1	101	917.3819	3/8" Hexagonal socket, 19 mm	1	125	911.3865	3/8" Bit socket hexagon, 5 mm	1
78	911.1707	1/4" Bit socket five star tamperproof, TS40	1	102	917.3820	3/8" Hexagonal socket, 20 mm	1	126	911.38655	3/8" Bit socket hexagon, 5,5 mm	1
79	911.1436	1/4" Bit socket hexagon, 3 mm	1	103	917.3821	3/8" Hexagonal socket, 21 mm	1	127	911.3866	3/8" Bit socket hexagon, 6 mm	1
80	911.1437	1/4" Bit socket hexagon, 4 mm	1	104	917.3822	3/8" Hexagonal socket, 22 mm	1	128	911.3867	3/8" Bit socket hexagon, 7 mm	1
81	911.1438	1/4" Bit socket hexagon, 5 mm	1	105	911.3961	3/8" Bit socket Torx tamperproof, TB15	1	129	911.3868	3/8" Bit socket hexagon, 8 mm	1
82	911.14385	1/4" Bit socket hexagon, 5,5 mm	1	106	911.3962	3/8" Bit socket Torx tamperproof, TB20	1	130	917.3969	3/8" Bit socket hexagon, 9 mm	1
83	911.1439	1/4" Bit socket hexagon, 6 mm	1	107	911.3963	3/8" Bit socket Torx tamperproof, TB25	1	131	917.3857	3/8" Bit socket hexagon, 10 mm	1
84	911.1440	1/4" Bit socket hexagon, 7 mm	1	108	911.3964	3/8" Bit socket Torx tamperproof, TB27	1	132	911.4338	3/8" Torx E Socket, E4	1
85	911.1441	1/4" Bit socket hexagon, 8 mm	1	109	911.3965	3/8" Bit socket Torx tamperproof, TB30	1	133	911.4339	3/8" Torx E Socket, E5	1
86	914.1410	Mini hand reversible ratchet, 1/4", 72 teethh	1	110	911.3966	3/8" Bit socket Torx tamperproof, TB40	1	134	911.4340	3/8" Torx E Socket, E6	1
87	914.3810	Mini hand reversible ratchet, 3/8", 72 teethh	1	111	911.3967	3/8" Bit socket Torx tamperproof, TB45	1	135	911.4341	3/8" Torx E Socket, E7	1
88	917.3806	3/8" Hexagonal socket, 6 mm	1	112	911.3968	3/8" Bit socket Torx tamperproof, TB50	1	136	911.4342	3/8" Torx E Socket, E8	1
89	917.3807	3/8" Hexagonal socket, 7 mm	1	113	911.3969	3/8" Bit socket Torx tamperproof, TB55	1	137	911.4318	3/8" Torx E Socket, E10	1
90	917.3808	3/8" Hexagonal socket, 8 mm	1	114	911.3869	3/8" Bit socket Torx, T15	1	138	911.4319	3/8" Torx E Socket, E11	1
91	917.3809	3/8" Hexagonal socket, 9 mm	1	115	911.3870	3/8" Bit socket Torx, T20	1	139	911.4320	3/8" Torx E Socket, E12	1
92	917.3810	3/8" Hexagonal socket, 10 mm	1	116	911.3871	3/8" Bit socket Torx, T25	1	140	911.4321	3/8" Torx E Socket, E14	1
93	917.3811	3/8" Hexagonal socket, 11 mm	1	117	911.3872	3/8" Bit socket Torx, T27	1				

M 1/2" Socket spanner set



568 x 398

P10

P10TC

P15

P20

P30

P35

P45

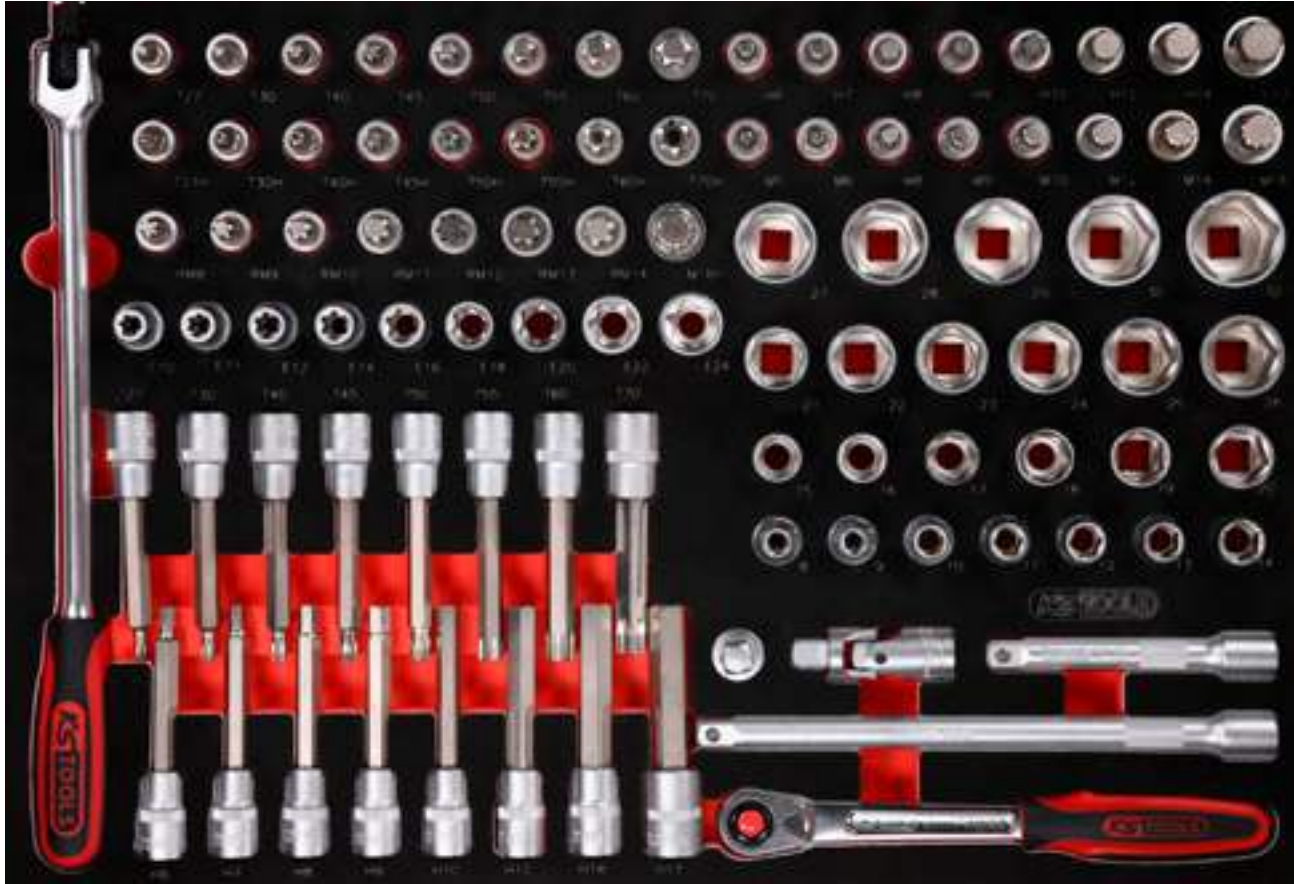

Pos.	Code	Description	pcs	Pos.	Code	Description	pcs	Pos.	Code	Description	pcs
1	917.1455	1/2" Flexi head drive handle	1	18	911.1373	1/2" Bit socket Torx tamperproof, TB27	1	35	911.4515	Bit socket for RIBE screws, M9, length 55 mm	1
2	911.1363	1/2" Bit socket Torx, T27	1	19	911.1374	1/2" Bit socket Torx tamperproof, TB30	1	36	911.4516	Bit socket for RIBE screws, M10, length 55 mm	1
3	911.1364	1/2" Bit socket Torx, T30	1	20	911.1375	1/2" Bit socket Torx tamperproof, TB40	1	37	911.4551	Bit socket for RIBE screws, M10.1, length 55 mm	1
4	911.1365	1/2" Bit socket Torx, T40	1	21	911.1376	1/2" Bit socket Torx tamperproof, TB45	1	38	911.4517	Bit socket for RIBE screws, M12, length 55 mm	1
5	911.1366	1/2" Bit socket Torx, T45	1	22	911.1377	1/2" Bit socket Torx tamperproof, TB50	1	39	911.4518	Bit socket for RIBE screws, M13, length 55 mm	1
6	911.1367	1/2" Bit socket Torx, T50	1	23	911.1378	1/2" Bit socket Torx tamperproof, TB55	1	40	911.4519	Bit socket for RIBE screws, M14, length 55 mm	1
7	911.1368	1/2" Bit socket Torx, T55	1	24	911.1379	1/2" Bit socket Torx tamperproof, TB60	1	41	911.1348	1/2" Bit socket spline (XZN) tamperproof, M16, 55 mm	1
8	911.1369	1/2" Bit socket Torx, T60	1	25	911.1380	1/2" Bit socket Torx tamperproof, TB70	1	42	917.1227	1/2" Hexagonal socket, 27 mm	1
9	911.1370	1/2" Bit socket Torx, T70	1	26	911.1340	1/2" Bit socket spline (XZN), M5, 55 mm	1	43	917.1344	1/2" Hexagonal socket, 28 mm	1
10	911.1306	1/2" Bit socket hexagon, short, 6 mm	1	27	911.1341	1/2" Bit socket spline (XZN), M6, 55 mm	1	44	917.1345	1/2" Hexagonal socket, 29 mm	1
11	911.1307	1/2" Bit socket hexagon, short, 7 mm	1	28	911.1342	1/2" Bit socket spline (XZN), M8, 55 mm	1	45	917.1230	1/2" Hexagonal socket, 30 mm	1
12	911.1308	1/2" Bit socket hexagon, short, 8 mm	1	29	911.1313	1/2" Bit socket spline (XZN), M9, 55 mm	1	46	917.1232	1/2" Hexagonal socket, 32 mm	1
13	911.1309	1/2" Bit socket hexagon, short, 9 mm	1	30	911.1343	1/2" Bit socket spline (XZN), M10, 55 mm	1	47	911.4333	1/2" Torx E Socket, E10	1
14	911.1310	1/2" Bit socket hexagon, short, 10 mm	1	31	911.1344	1/2" Bit socket spline (XZN), M12, 55 mm	1	48	911.4334	1/2" Torx E Socket, E11	1
15	911.1312	1/2" Bit socket hexagon, short, 12 mm	1	32	911.1345	1/2" Bit socket spline (XZN), M14, 55 mm	1	49	911.4335	1/2" Torx E Socket, E12	1
16	911.1314	1/2" Bit socket hexagon, short, 14 mm	1	33	911.1346	1/2" Bit socket spline (XZN), M16, 55 mm	1	50	911.4336	1/2" Torx E Socket, E14	1
17	911.1317	1/2" Bit socket hexagon, short, 17 mm	1	34	911.4514	Bit socket for RIBE screws, M8, length 55 mm	1				

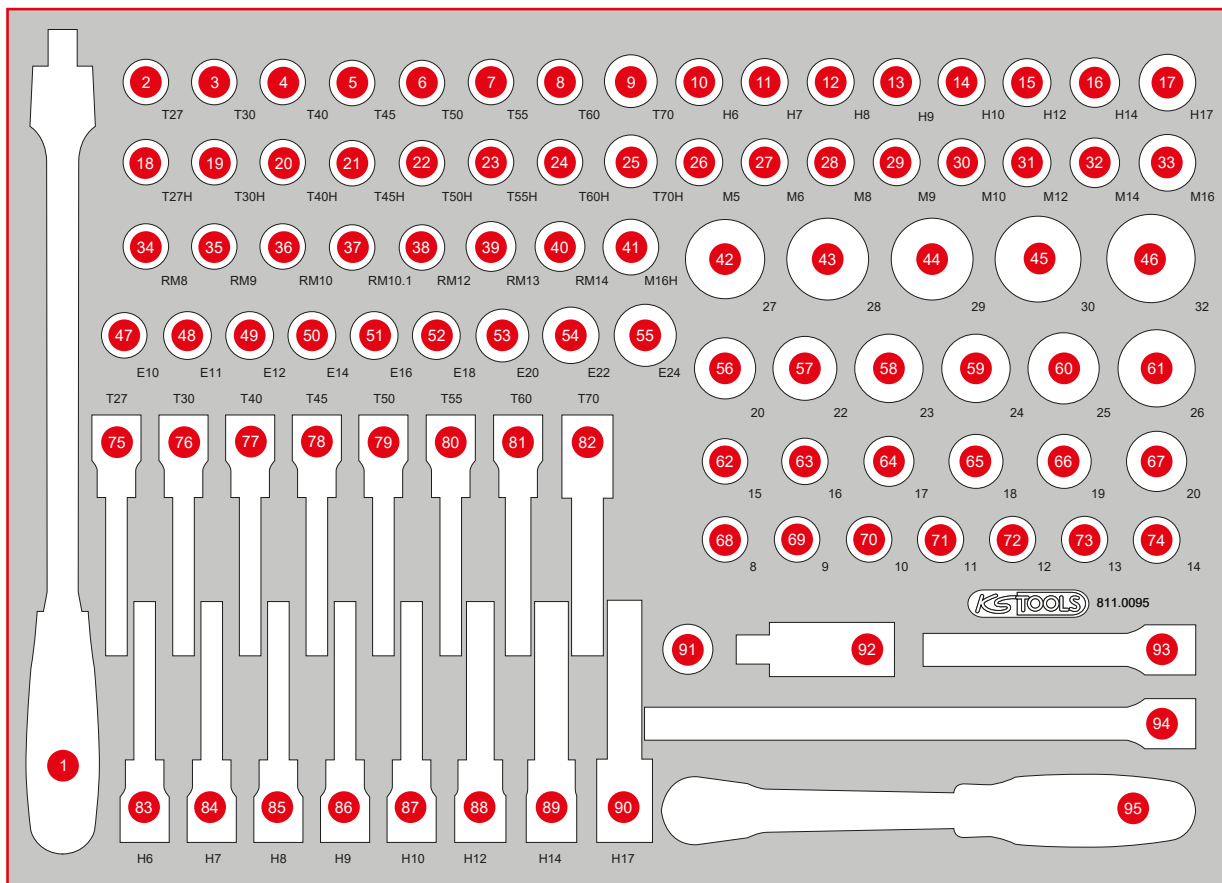

Pos.	Code	Description	pcs	Pos.	Code	Description	pcs	Pos.	Code	Description	pcs
51	911.4322	1/2" Torx E Socket, E16	1	68	917.1340	1/2" Hexagonal socket, 8 mm	1	77	911.1525	1/2" Bit socket Torx, long, T40	1
52	911.4323	1/2" Torx E Socket, E18	1	69	917.1341	1/2" Hexagonal socket, 9 mm	1	78	911.1526	1/2" Bit socket Torx, long, T45	1
53	911.4324	1/2" Torx E Socket, E20	1	70	917.1210	1/2" Hexagonal socket, 10 mm	1	79	911.1527	1/2" Bit socket Torx, long, T50	1
54	911.4325	1/2" Torx E Socket, E22	1	71	917.1211	1/2" Hexagonal socket, 11 mm	1	80	911.1528	1/2" Bit socket Torx, long, T55	1
55	911.4326	1/2" Torx E Socket, E24	1	72	917.1212	1/2" Hexagonal socket, 12 mm	1	81	911.1529	1/2" Bit socket Torx, long, T60	1
56	917.1221	1/2" Hexagonal socket, 21 mm	1	73	917.1213	1/2" Hexagonal socket, 13 mm	1	82	911.1517	1/2" Bit socket Torx, long, T70	1
57	917.1222	1/2" Hexagonal socket, 22 mm	1	74	917.1214	1/2" Hexagonal socket, 14 mm	1	91	911.1207	3/8" Sliding adaptor, 3/8" F x 1/2" M	1
58	917.1223	1/2" Hexagonal socket, 23 mm	1	83	911.1326	1/2" Bit socket hexagon, long, 6 mm	1	92	911.1250	1/2" Universal joint	1
59	917.1224	1/2" Hexagonal socket, 24 mm	1	84	911.1327	1/2" Bit socket hexagon, long, 7 mm	1	93	911.1202	1/2" Extensions, 125 mm	1
60	917.1342	1/2" Hexagonal socket, 25 mm	1	85	911.1328	1/2" Bit socket hexagon, long, 8 mm	1	94	911.1203	1/2" Extensions, 250 mm	1
61	917.1343	1/2" Hexagonal socket, 26 mm	1	86	911.1329	1/2" Bit socket hexagon, long, 9 mm	1	95	920.1290	1/2" SlimPOWER Reversible ratchet, 72 teeth	1
62	917.1215	1/2" Hexagonal socket, 15 mm	1	87	911.1330	1/2" Bit socket hexagon, long, 10 mm	1				
63	917.1216	1/2" Hexagonal socket, 16 mm	1	88	911.1332	1/2" Bit socket hexagon, long, 12 mm	1				
64	917.1217	1/2" Hexagonal socket, 17 mm	1	89	917.1332	1/2" Bit socket hexagon, long, 14 mm	1				
65	917.1218	1/2" Hexagonal socket, 18 mm	1	90	911.1337	1/2" Bit socket hexagon, long, 17 mm	1				
66	917.1219	1/2" Hexagonal socket, 19 mm	1	75	911.1523	1/2" Bit socket Torx, long, T27	1				
67	917.1220	1/2" Hexagonal socket, 20 mm	1	76	911.1524	1/2" Bit socket Torx, long, T30	1				

811.0030

M Combination spanner set

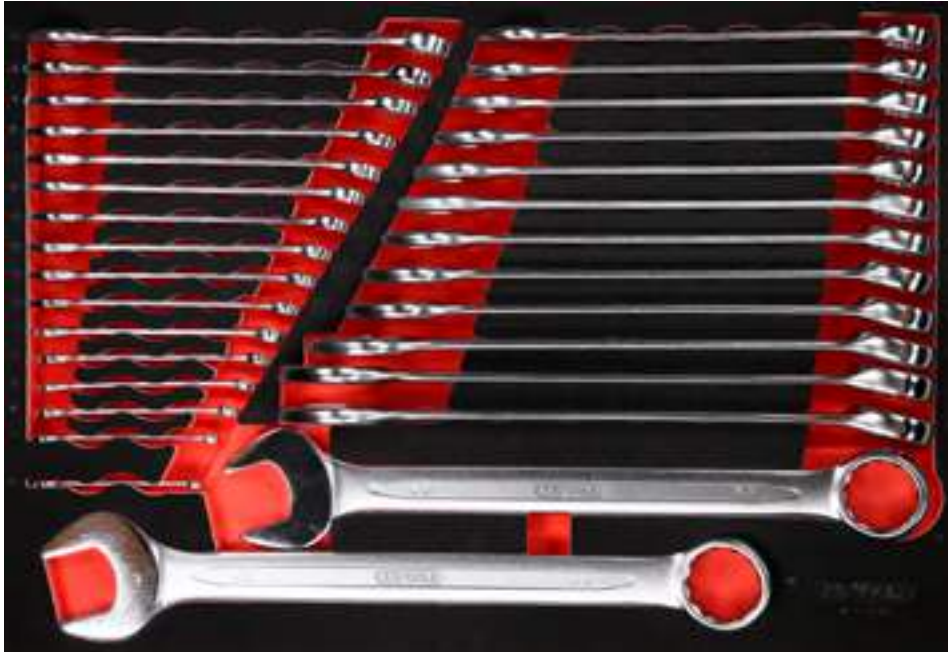

Pos.	Code	Description	pcs
1	517.0606	Combination spanners, offset, 6 mm	1
2	517.0607	Combination spanners, offset, 7 mm	1
3	517.0608	Combination spanners, offset, 8 mm	1
4	517.0609	Combination spanners, offset, 9 mm	1
5	517.0610	Combination spanners, offset, 10 mm	1
6	517.0611	Combination spanners, offset, 11 mm	1
7	517.0612	Combination spanners, offset, 12 mm	1
8	517.0613	Combination spanners, offset, 13 mm	1
9	517.0614	Combination spanners, offset, 14 mm	1
10	517.0615	Combination spanners, offset, 15 mm	1
11	517.0616	Combination spanners, offset, 16 mm	1
12	517.0617	Combination spanners, offset, 17 mm	1
13	517.0618	Combination spanners, offset, 18 mm	1
14	517.0619	Combination spanners, offset, 19 mm	1
15	517.0620	Combination spanners, offset, 20 mm	1
16	517.0621	Combination spanners, offset, 21 mm	1
17	517.0622	Combination spanners, offset, 22 mm	1
18	517.0623	Combination spanners, offset, 23 mm	1
19	517.0624	Combination spanners, offset, 24 mm	1
20	517.0625	Combination spanners, offset, 25 mm	1
21	517.0626	Combination spanners, offset, 26 mm	1
22	517.0627	Combination spanners, offset, 27 mm	1
23	517.0628	Combination spanners, offset, 28 mm	1
24	517.0629	Combination spanners, offset, 29 mm	1
25	517.0630	Combination spanners, offset, 30 mm	1
26	517.0632	Combination spanners, offset, 32 mm	1
27	517.0337	Combination spanners, offset, 33 mm	1
28	517.0634	Combination spanners, offset, 34 mm	1
29	517.0636	Combination spanners, offset, 36 mm	1
30	517.0638	Combination spanners, offset, 38 mm	1

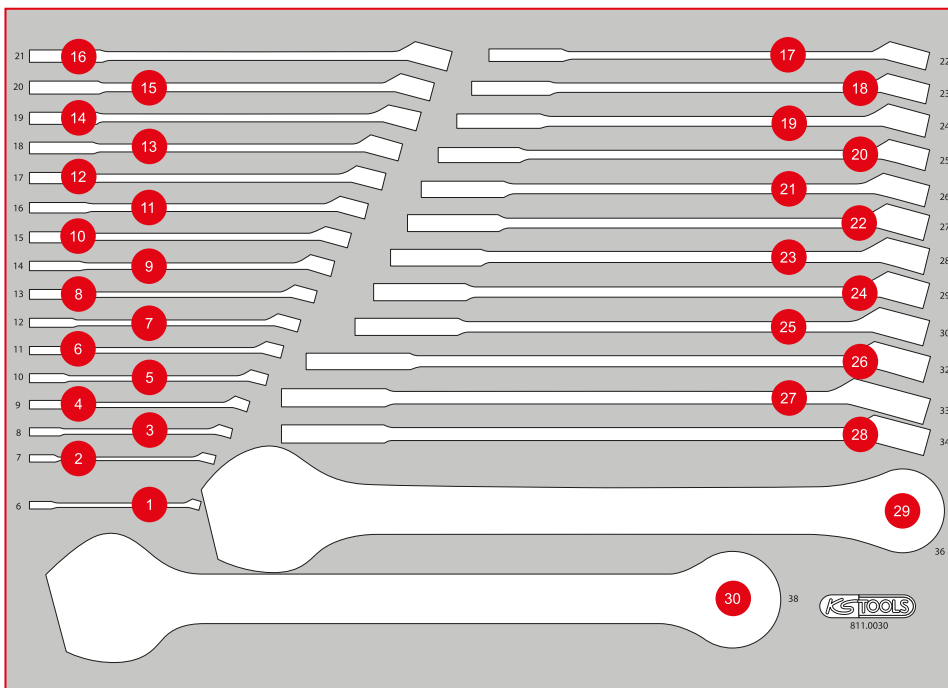

811.0051

M Screw spanner set



Pos.	Code	Description	pcs	Pos.	Code	Description	pcs	Pos.	Code	Description	pcs
1	518.0856	CHROMEplus Starter and block spanner, 14 x 17 mm	1	13	517.0258	Open double ring spanner, offset, 12 x 14 mm	1	25	920.0414	ULTIMATEplus Double ring ended spanner, 14 x 15 mm	1
2	518.0853	CHROMEplus Starter and block spanner, 11 x 13 mm	1	14	517.9244	Open double ring spanner, offset, 11 x 13 mm	1	26	920.0412	ULTIMATEplus Double ring ended spanner, 12 x 13 mm	1
3	518.0852	CHROMEplus Starter and block spanner, 10 x 12 mm	1	15	517.0252	Open double ring spanner, offset, 8 x 10 mm	1	27	920.0410	ULTIMATEplus Double ring ended spanner, 10 x 11 mm	1
4	503.4290	GEARplus bit adaptor, 1/4" x 10 mm	1	16	517.0300	Double revolving head spanner, 6 x 7 mm	1	28	920.0408	ULTIMATEplus Double ring ended spanner, 8 x 9 mm	1
5	503.4296	GEARplus socket adaptor, 1/4" x 10 mm	1	17	517.0301	Double revolving head spanner, 8 x 9 mm	1	29	920.0406	ULTIMATEplus Double ring ended spanner, 6 x 7 mm	1
6	503.4297	GEARplus socket adaptor, 3/8" x 13 mm	1	18	517.0302	Double revolving head spanner, 10 x 11 mm	1	30	518.0017	CHROMEplus Combination spanner, stubby, 17 mm	1
7	503.4298	GEARplus socket adaptor, 1/2" x 19 mm	1	19	517.0303	Double revolving head spanner, 12 x 13 mm	1	31	518.0016	CHROMEplus Combination spanner, stubby, 16 mm	1
8	517.0269	Open double ring spanner, offset, 30 x 32 mm	1	20	517.0304	Double revolving head spanner, 14 x 15 mm	1	32	518.0015	CHROMEplus Combination spanner, stubby, 15 mm	1
9	517.0268	Open double ring spanner, offset, 24 x 27 mm	1	21	517.0305	Double revolving head spanner, 16 x 17 mm	1				
10	517.0266	Open double ring spanner, offset, 19 x 22 mm	1	22	517.0306	Double revolving head spanner, 18 x 19 mm	1				
11	517.0264	Open double ring spanner, offset, 17 x 19 mm	1	23	920.0418	ULTIMATEplus Double ring ended spanner, 18 x 19 mm	1				
12	517.0263	Open double ring spanner, offset, 16 x 18 mm	1	24	920.0416	ULTIMATEplus Double ring ended spanner, 16 x 17 mm	1				

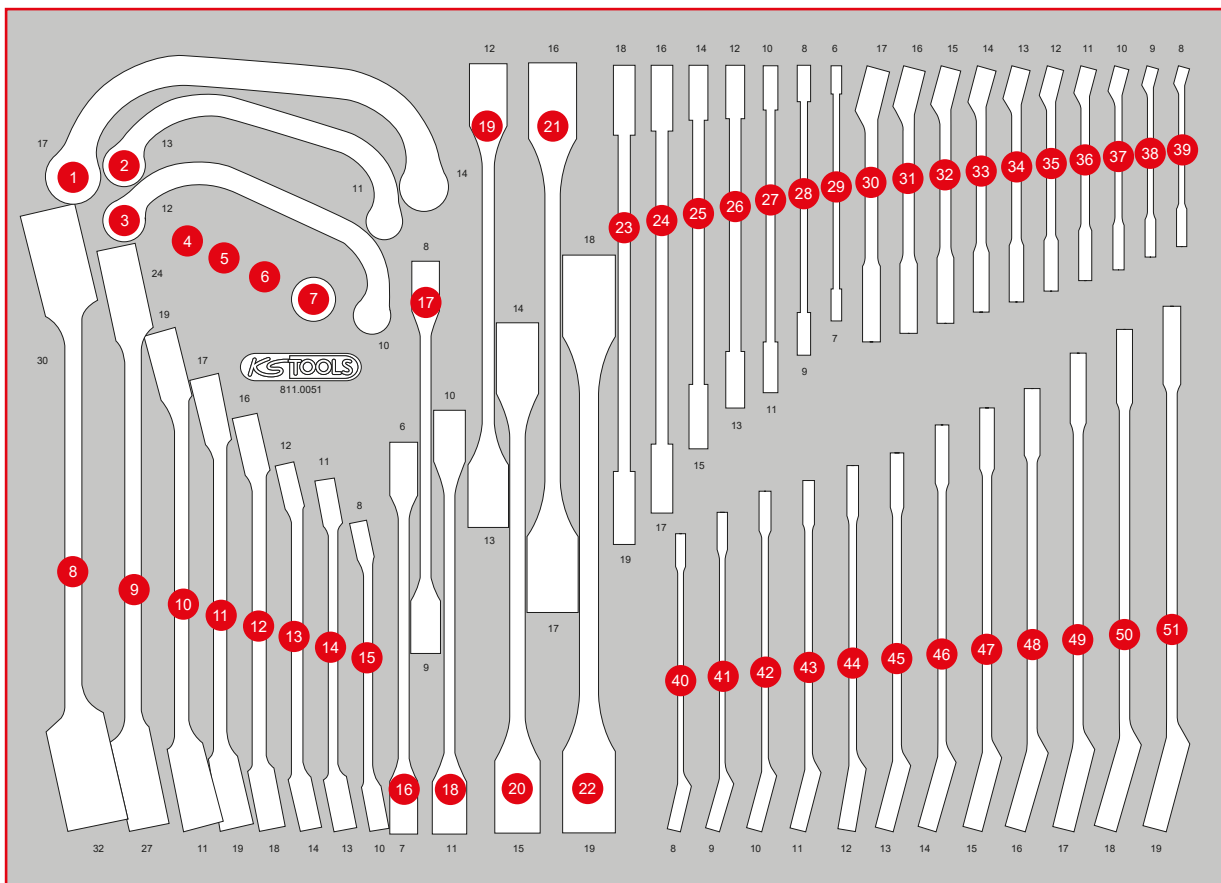

Pos.	Code	Description	pcs	Pos.	Code	Description	pcs	Pos.	Code	Description	pcs
33	518.0014	CHROMEplus Combination spanner, stubby, 14 mm	1	41	503.4609	GEARplus reversing combination ratcheting spanner, 9 mm	1	48	503.4616	GEARplus reversing combination ratcheting spanner, 16 mm	1
34	518.0013	CHROMEplus Combination spanner, stubby, 13 mm	1	42	503.4610	GEARplus reversing combination ratcheting spanner, 10 mm	1	49	503.4617	GEARplus reversing combination ratcheting spanner, 17 mm	1
35	518.0012	CHROMEplus Combination spanner, stubby, 12 mm	1	43	503.4611	GEARplus reversing combination ratcheting spanner, 11 mm	1	50	503.4618	GEARplus reversing combination ratcheting spanner, 18 mm	1
36	518.0011	CHROMEplus Combination spanner, stubby, 11 mm	1	44	503.4612	GEARplus reversing combination ratcheting spanner, 12 mm	1	51	503.4619	GEARplus reversing combination ratcheting spanner, 19 mm	1
37	518.0010	CHROMEplus Combination spanner, stubby, 10 mm	1	45	503.4613	GEARplus reversing combination ratcheting spanner, 13 mm	1				
38	518.0008	CHROMEplus Combination spanner, stubby, 9 mm	1	46	503.4614	GEARplus reversing combination ratcheting spanner, 14 mm	1				
39	518.0007	CHROMEplus Combination spanner, stubby, 8 mm	1	47	503.4615	GEARplus reversing combination ratcheting spanner, 15 mm	1				
40	503.4608	GEARplus reversing combination ratcheting spanner, 8 mm	1								

M T-handle and screwdriver set

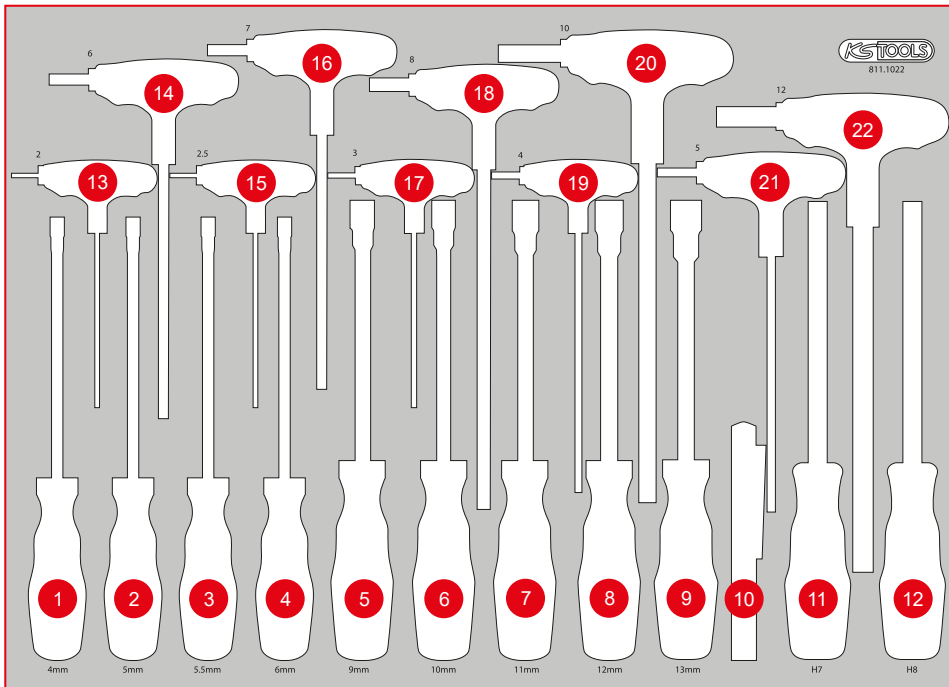
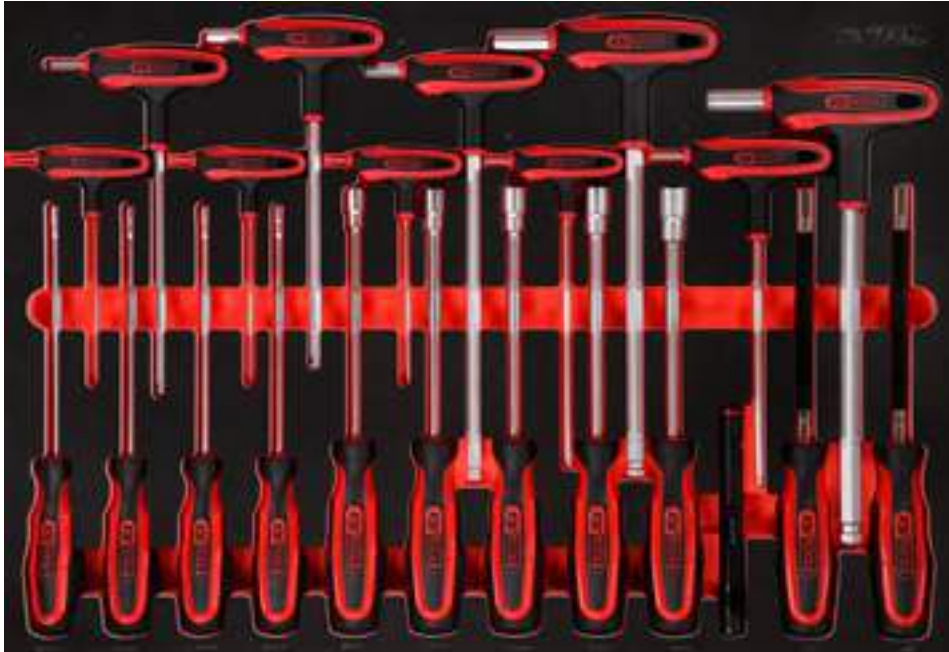
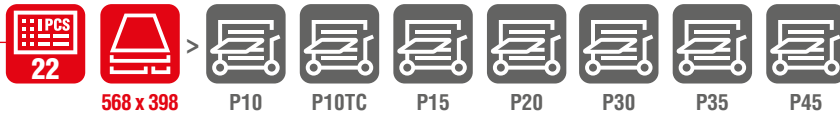

Pos.	Code	Description	pcs
1	159.1201	ERGOTORQUEplus Socket screwdriver, 4 mm	1
2	159.1202	ERGOTORQUEplus Socket screwdriver, 5 mm	1
3	159.1203	ERGOTORQUEplus Socket screwdriver, 5,5 mm	1
4	159.1204	ERGOTORQUEplus Socket screwdriver, 6 mm	1
5	159.1207	ERGOTORQUEplus Socket screwdriver, 9 mm	1
6	159.1208	ERGOTORQUEplus Socket screwdriver, 10 mm	1
7	159.1209	ERGOTORQUEplus Socket screwdriver, 11 mm	1
8	159.1210	ERGOTORQUEplus Socket screwdriver, 12 mm	1
9	159.1211	ERGOTORQUEplus Socket screwdriver, 13 mm	1
10	150.4370	perfectLight torch 85 lumen	1
11	159.1127	ERGOTORQUEplus Socket screwdriver, 7 mm	1
12	159.2128	ERGOTORQUEplus Socket screwdriver, 8 mm	1
13	151.8130	T-handle ball ended hexagon key wrench, 2 mm	1
14	151.8135	T-handle ball ended hexagon key wrench, 6 mm	1
15	151.8131	T-handle ball ended hexagon key wrench, 2,5 mm	1
16	151.8136	T-handle ball ended hexagon key wrench, 7 mm	1
17	151.8132	T-handle ball ended hexagon key wrench, 3 mm	1
18	151.8137	T-handle ball ended hexagon key wrench, 8 mm	1
19	151.8133	T-handle ball ended hexagon key wrench, 4 mm	1
20	151.8138	T-handle ball ended hexagon key wrench, 10 mm	1
21	151.8134	T-handle ball ended hexagon key wrench, 5 mm	1
22	151.8139	T-handle ball ended hexagon key wrench, 12 mm	1

811.0021

M Hammer, chisel and file set



Pos.	Code	Description	pcs
1	140.5252	Recoil free soft faced Hammer, 400 g	1
2	142.1402	Fitters Hammer, fiberglas handle, 400 g	1
3	142.5101	Club Hammer, fiberglas handle, 1000 g	1
4	156.0242	Cross chisel, octagon, 7 mm	1
5	156.0234	Pin punch, Ø 6 mm, cylindrical shaft	1
6	156.0233	Pin punch, Ø 5 mm, cylindrical shaft	1
7	156.0232	Pin punch, cylindrical shaft, 4 mm	1
8	156.0231	Pin punch, cylindrical shaft, 3 mm	1
9	300.0510	Pocket vernier calliper 0-150 mm, 235 mm	1
10	157.0405	Tri-bastard file, form C, cut 2, 200 mm	1
11	157.0960	Brake saddle file, extra narrow, 270 mm	1
12	157.0205	Round file, form F, cut 2, 200 mm	1
13	156.0243	Centre punch, octagon 10 mm	1
14	156.0238	Punch, Ø 4 mm, conical	1
15	156.0237	Punch, Ø 3 mm, conical	1
16	156.0252	Flat chisel, octagon, 12 mm	1
17	156.0253	Flat chisel, octagon, 16 mm	1
18	156.0254	Flat chisel, octagon, 18 mm	1
19	156.0241	Flat chisel, octagon, 20 mm	1
20	201.2335	Steel wire brake saddle brush, 2-row, straight	1
21	300.0104	Flexible steel rule, 300 mm	1

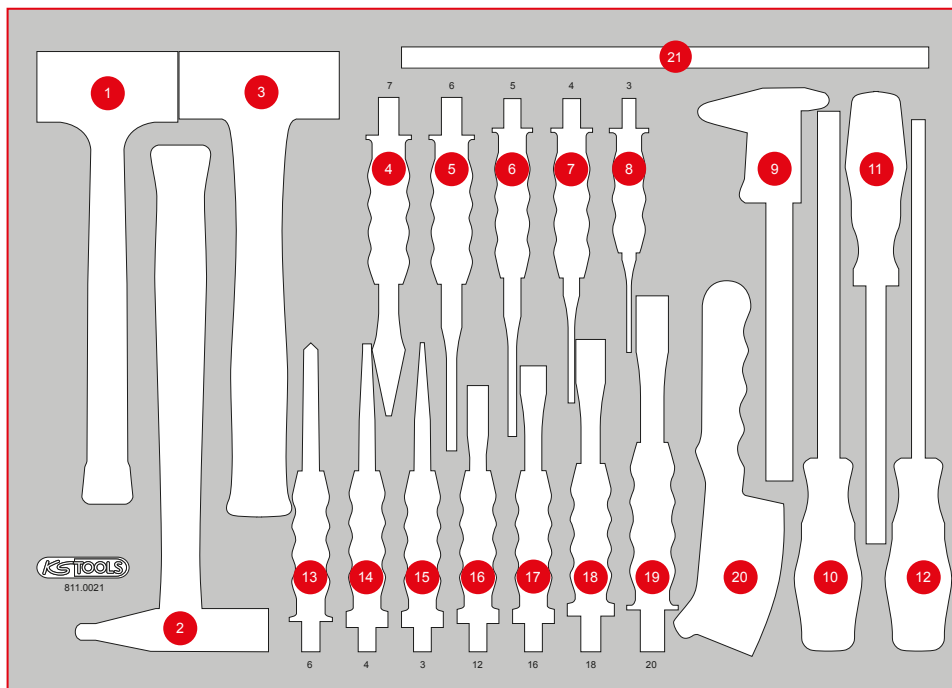

812.0005

S Spanner set



268 x 398

P35

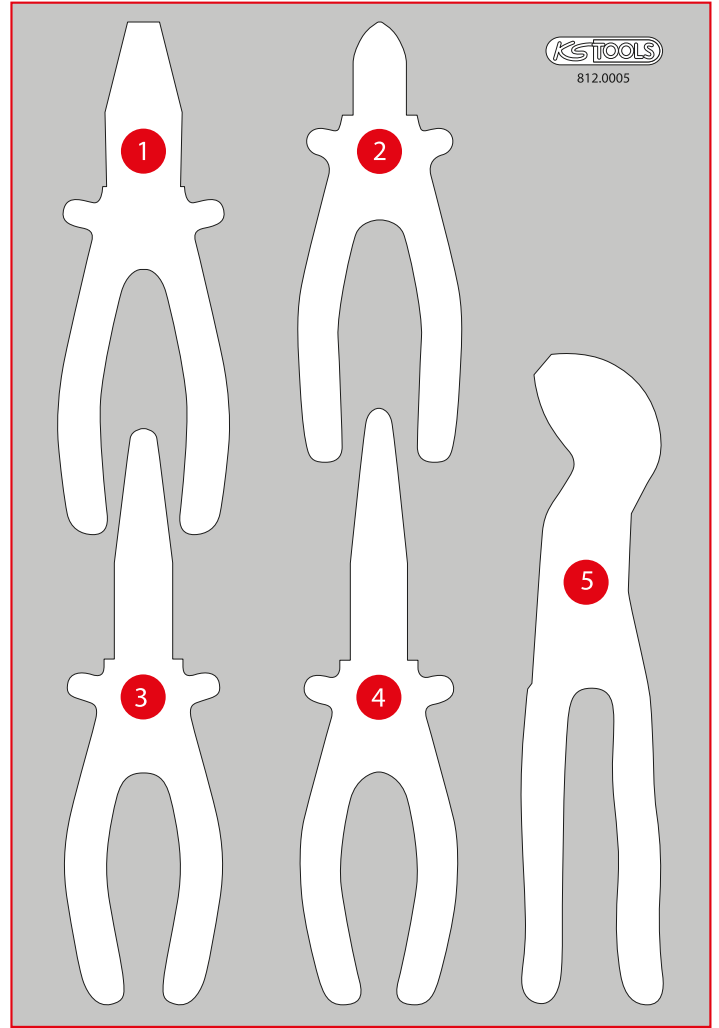

Pos.	Code	Description	pcs
1	115.1021	ERGOTORQUE combination pliers,180 mm	1
2	115.1012	ERGOTORQUE diagonal side cutter, 160 mm	1
3	115.1019	ERGOTORQUE bent nose pliers serrated, 210 mm	1
4	115.1024	ERGOTORQUE long nose pliers serrated cutter, 200 mm	1
5	115.2010	Water pump pliers, 240 mm	1

812.0007

S Spanner set

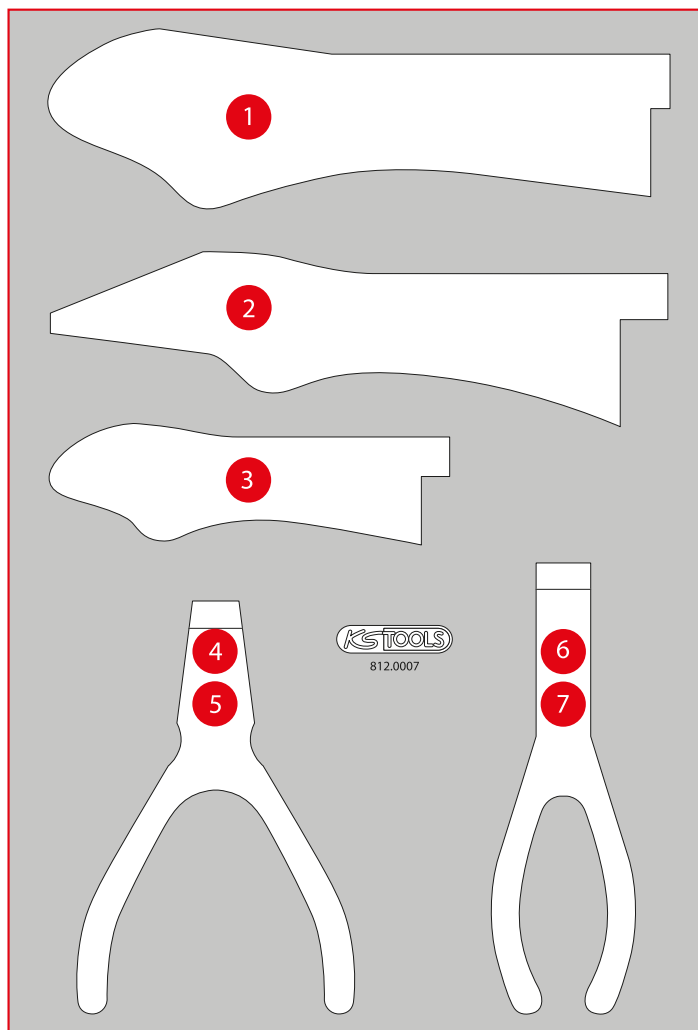

Pos.	Code	Description	pcs
1	115.1033	Locking pliers, 60 mm, L = 220 mm	1
2	115.1035	Longbacken-Locking pliers, 210 mm	1
3	115.1031	Locking pliers, 50 mm, L = 140 mm	1
4	500.1029	Circlip pliers for external circlips, 160 mm	1
5	500.1026	Circlip pliers for external circlips, angled, 160 mm	1
6	500.1035	Circlip pliers for internal circlips, 160 mm	1
7	500.1032	Circlip pliers for internal circlips, angled, 160 mm	1

P 10
P 15
P 20
P 25
P 30
P 35
P 40
P 45
Individual parts S XL L M
Accessories

811.0073

M 3/8" + 1/2" socket spanner set

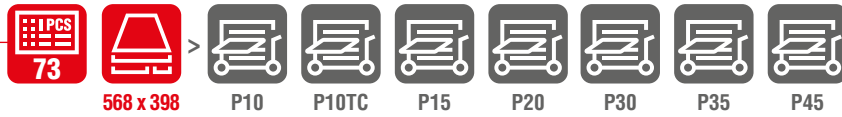

Pos.	Code	Description	pcs	Pos.	Code	Description	pcs	Pos.	Code	Description	pcs
1	515.1508	3/8" Hexagon impact socket, short, 8 mm	1	14	515.1012	1/2" Hexagon impact socket short, 12 mm	1	27	515.1025	1/2" Hexagon impact socket short, 25 mm	1
2	515.1510	3/8" Hexagon impact socket, short, 10 mm	1	15	515.1013	1/2" Hexagon impact socket short, 13 mm	1	28	515.1026	1/2" Hexagon impact socket short, 26 mm	1
3	515.1511	3/8" Hexagon impact socket, short, 11 mm	1	16	515.1014	1/2" Hexagon impact socket short, 14 mm	1	29	515.1027	1/2" Hexagon impact socket short, 27 mm	1
4	515.1512	3/8" Hexagon impact socket, short, 12 mm	1	17	515.1015	1/2" Hexagon impact socket short, 15 mm	1	30	515.1028	1/2" Hexagon impact socket short, 28 mm	1
5	515.1513	3/8" Hexagon impact socket, short, 13 mm	1	18	515.1016	1/2" Hexagon impact socket short, 16 mm	1	31	515.1029	1/2" Hexagon impact socket short, 29 mm	1
6	515.1514	3/8" Hexagon impact socket, short, 14 mm	1	19	515.1017	1/2" Hexagon impact socket short, 17 mm	1	32	515.1030	1/2" Hexagon impact socket short, 30 mm	1
7	515.1515	3/8" Hexagon impact socket, short, 15 mm	1	20	515.1018	1/2" Hexagon impact socket short, 18 mm	1	33	515.1032	1/2" Hexagon impact socket short, 32 mm	1
8	515.1516	3/8" Hexagon impact socket, short, 16 mm	1	21	515.1019	1/2" Hexagon impact socket short, 19 mm	1	34	515.1144	1/2" Impact adaptor, 1/2" F x 3/4" M	1
9	515.1517	3/8" Hexagon impact socket, short, 17 mm	1	22	515.1020	1/2" Hexagon impact socket short, 20 mm	1	35	515.1143	1/2" Impact adaptor, 1/2" F x 3/8" M	1
10	515.1519	3/8" Hexagon impact socket, short, 19 mm	1	23	515.1021	1/2" Hexagon impact socket short, 21 mm	1	36	515.1532	Impact adaptor, F 3/8" x 1/2" M	1
11	515.1008	1/2" Hexagon impact socket short, 8 mm	1	24	515.1022	1/2" Hexagon impact socket short, 22 mm	1	37	515.1531	Impact adaptor, F 3/8" x 1/4" M	1
12	515.1010	1/2" Hexagon impact socket short, 10 mm	1	25	515.1023	1/2" Hexagon impact socket short, 23 mm	1	38	515.1599	Impact bit adaptor socket, 3/8" x 1/4"	1
13	515.1011	1/2" Hexagon impact socket short, 11 mm	1	26	515.1024	1/2" Hexagon impact socket short, 24 mm	1	39	515.1135	1/2" Impact extension, 125 mm	1

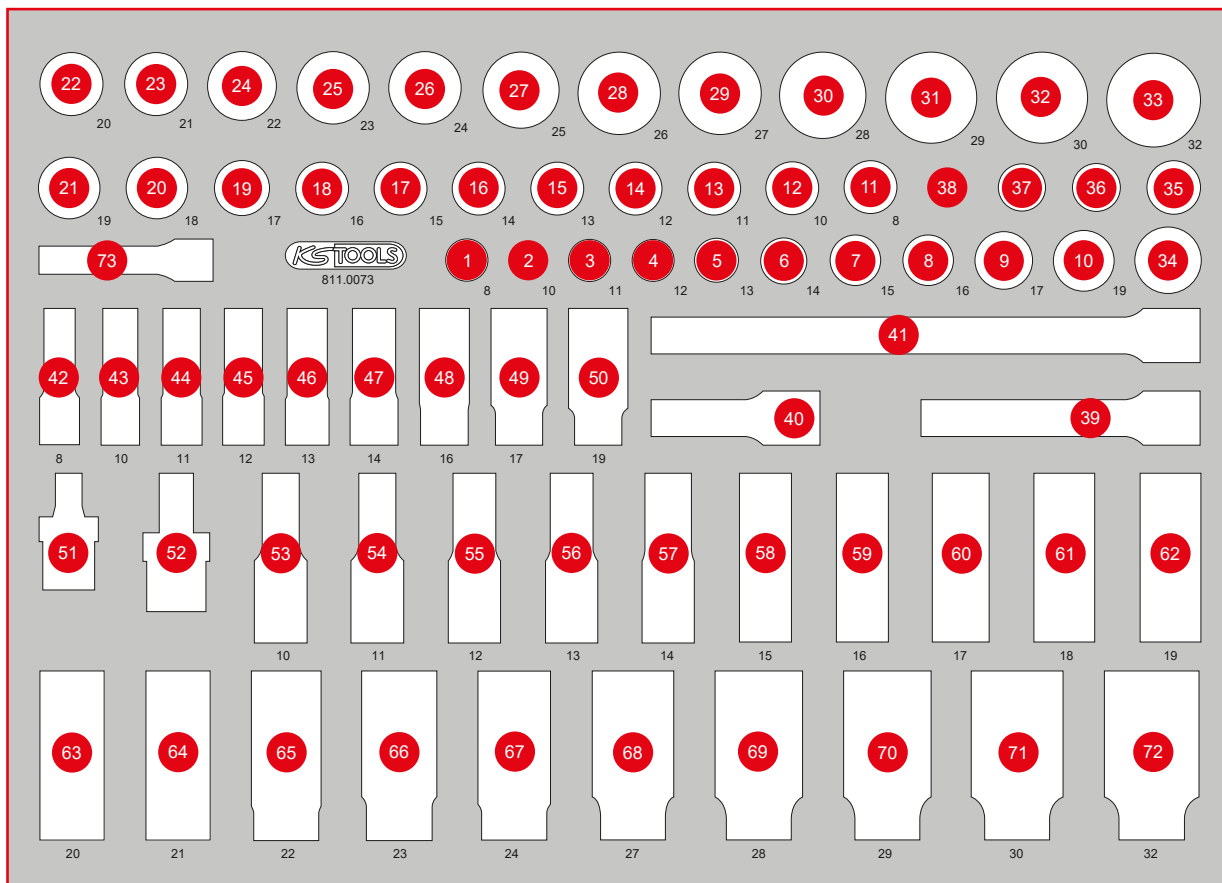

Pos.	Code	Description	pcs	Pos.	Code	Description	pcs	Pos.	Code	Description	pcs
40	515.1134	1/2" Impact extension, 75 mm	1	53	515.1110	1/2" Hexagon impact socket, deep, 10 mm	1	66	515.1123	1/2" Hexagon impact socket, deep, 23 mm	1
41	515.1136	1/2" Impact extension, 250 mm	1	54	515.1111	1/2" Hexagon impact socket, deep, 11 mm	1	67	515.1124	1/2" Hexagon impact socket, deep, 24 mm	1
42	515.1608	3/8" Hexagon impact socket, deep, 8 mm	1	55	515.1112	1/2" Hexagon impact socket, deep, 12 mm	1	68	515.1127	1/2" Hexagon impact socket, deep, 27 mm	1
43	515.1610	3/8" Hexagon impact socket, deep, 10 mm	1	56	515.1113	1/2" Hexagon impact socket, deep, 13 mm	1	69	515.1128	1/2" Hexagon impact socket, deep, 28 mm	1
44	515.1611	3/8" Hexagon impact socket, deep, 11 mm	1	57	515.1114	1/2" Hexagon impact socket, deep, 14 mm	1	70	515.1129	1/2" Hexagon impact socket, deep, 29 mm	1
45	515.1612	3/8" Hexagon impact socket, deep, 12 mm	1	58	515.1115	1/2" Hexagon impact socket, deep, 15 mm	1	71	515.1130	1/2" Hexagon impact socket, deep, 30 mm	1
46	515.1613	3/8" Hexagon impact socket, deep, 13 mm	1	59	515.1116	1/2" Hexagon impact socket, deep, 16 mm	1	72	515.1132	1/2" Hexagon impact socket, deep, 32 mm	1
47	515.1614	3/8" Hexagon impact socket, deep, 14 mm	1	60	515.1117	1/2" Hexagon impact socket, deep, 17 mm	1	73	515.1534	3/8" Impact extension, 75 mm	1
48	515.1616	3/8" Hexagon impact socket, deep, 16 mm	1	61	515.1118	1/2" Hexagon impact socket, deep, 18 mm	1				
49	515.1617	3/8" Hexagon impact socket, deep, 17 mm	1	62	515.1119	1/2" Hexagon impact socket, deep, 19 mm	1				
50	515.1619	3/8" Hexagon impact socket, deep, 19 mm	1	63	515.1120	1/2" Hexagon impact socket, deep, 20 mm	1				
51	515.1533	3/8" Impact universal ball joint	1	64	515.1121	1/2" Hexagon impact socket, deep, 21 mm	1				
52	515.1133	1/2" Impact universal ball joint	1	65	515.1122	1/2" Hexagon impact socket, deep, 22 mm	1				

811.0032

M 3/4" Socket spanner set

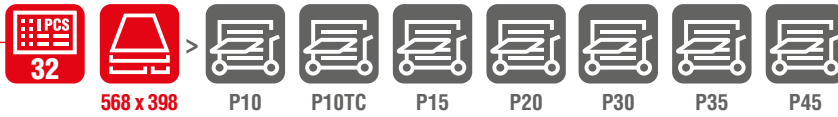

Pos.	Code	Description	pcs
1	911.3400	3/4" Reversible ratchet, 72 teeth	1
2	911.3405	3/4" Sliding T-handle, 450 mm	1
3	911.3404	3/4" Extensions, 400 mm	1
4	911.3470	3/4" Flexi head drive handle, 500 mm	1
5	911.3518	3/4" 12 Point socket, short, 19 mm	1
6	911.3525	3/4" 12 Point socket, short, 21 mm	1
7	911.3528	3/4" 12 Point socket, short, 22 mm	1
8	911.3533	3/4" 12 Point socket, short, 24 mm	1
9	911.3537	3/4" 12 Point socket, short, 27 mm	1
10	911.3542	3/4" 12 Point socket, short, 30 mm	1
11	911.3543	3/4" 12 Point socket, short, 32 mm	1
12	911.3544	3/4" 12 Point socket, short, 33 mm	1
13	911.3545	3/4" 12 Point socket, short, 34 mm	1
14	911.3548	3/4" 12 Point socket, short, 36 mm	1
15	911.3549	3/4" 12 Point socket, short, 38 mm	1
16	911.3557	3/4" 12 Point socket, short, 41 mm	1
17	911.3598	3/4" 12 Point socket, short, 46 mm	1
18	911.3599	3/4" 12 Point socket, short, 50 mm	1
19	911.3522	3/4" 12 Point socket, short, 7/8"	1
20	911.3523	3/4" 12 Point socket, short, 15/16"	1
21	911.3524	3/4" 12 Point socket, short, 1"	1
22	911.3526	3/4" 12 Point socket, short, 1.1/16"	1
23	911.3527	3/4" 12 Point socket, short, 1.1/8"	1
24	911.3529	3/4" 12 Point socket, short, 1.3/16"	1
25	911.3530	3/4" 12 Point socket, short, 1.1/4"	1
26	911.3532	3/4" 12 Point socket, short, 1.5/16"	1
27	911.3535	3/4" 12 Point socket, short, 1.3/8"	1
28	911.3536	3/4" 12 Point socket, short, 1.7/16"	1
29	911.3538	3/4" 12 Point socket, short, 1.1/2"	1
30	911.3541	3/4" 12 Point socket, short, 1.5/8"	1
31	911.3546	3/4" 12 Point socket, short, 1.3/4"	1
32	911.3457	3/4" 12 Point socket, short, 1.7/8"	1

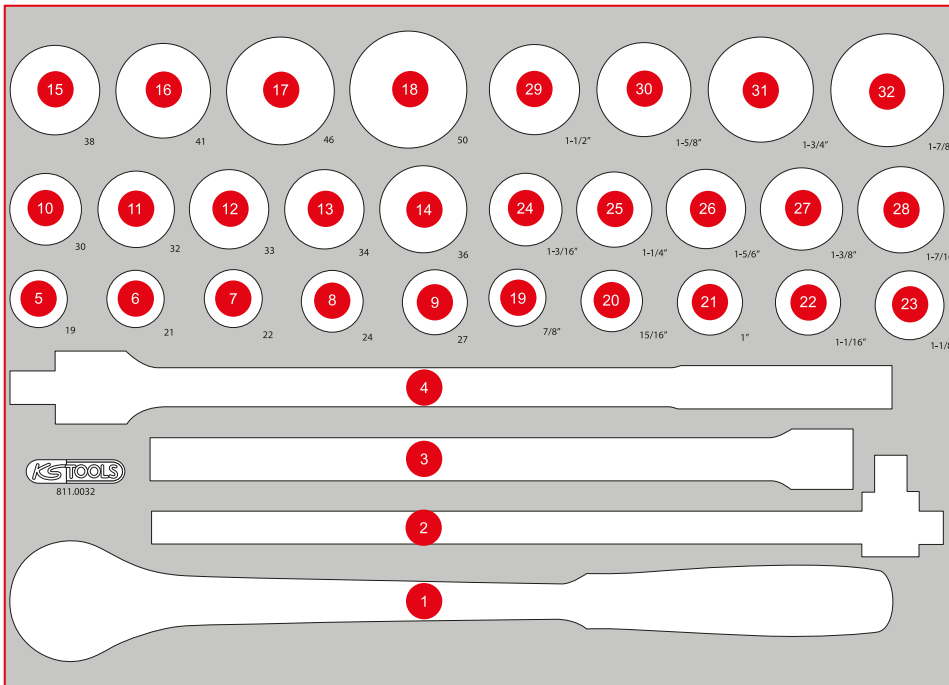

811.1033

M 3/4 " Impact socket set



Pos.	Code	Description	pcs
1	515.1319	3/4" Hexagon impact socket, short, 19 mm	1
2	515.1321	3/4" Hexagon impact socket, short, 21 mm	1
3	515.1322	3/4" Hexagon impact socket, short, 22 mm	1
4	515.1323	3/4" Hexagon impact socket, short, 23 mm	1
5	515.1324	3/4" Hexagon impact socket, short, 24 mm	1
6	515.1327	3/4" Hexagon impact socket, short, 27 mm	1
7	515.1328	3/4" Hexagon impact socket, short, 28 mm	1
8	515.1330	3/4" Hexagon impact socket, short, 30 mm	1
9	515.1332	3/4" Hexagon impact socket, short, 32 mm	1
10	515.1333	3/4" Hexagon impact socket, short, 33 mm	1
11	515.1334	3/4" Hexagon impact socket, short, 34 mm	1
12	515.1336	3/4" Hexagon impact socket, short, 36 mm	1
13	515.1338	3/4" Hexagon impact socket, short, 38 mm	1
14	515.1341	3/4" Hexagon impact socket, short, 41 mm	1
15	515.1346	3/4" Hexagon impact socket, short, 46 mm	1
16	515.1419	3/4" Hexagon impact socket, deep, 19 mm	1
17	515.1421	3/4" Hexagon impact socket, deep, 21 mm	1
18	515.1422	3/4" Hexagon impact socket, deep, 22 mm	1
19	515.1423	3/4" Hexagon impact socket, deep, 23 mm	1
20	515.1424	3/4" Hexagon impact socket, deep, 24 mm	1
21	515.1427	3/4" Hexagon impact socket, deep, 27 mm	1
22	515.1430	3/4" Hexagon impact socket, deep, 30 mm	1
23	515.1432	3/4" Hexagon impact socket, deep, 32 mm	1
24	515.1433	3/4" Hexagon impact socket, deep, 33 mm	1
25	515.1434	3/4" Hexagon impact socket, deep, 34 mm	1
26	515.1436	3/4" Hexagon impact socket, deep, 36 mm	1
27	515.1438	3/4" Hexagon impact socket, deep, 38 mm	1
28	515.1441	3/4" Hexagon impact socket, deep, 41 mm	1
29	515.1446	3/4" Hexagon impact socket, deep, 46 mm	1
30	515.1374	3/4" Impact joint+suspension	1
31	515.1377	3/4" Impact extension, 150 mm	1
32	515.1372	Impact adaptor, F 3/4" x 1/2" M	1
33	515.1373	Impact adaptor, F 3/4" x 1" M	1

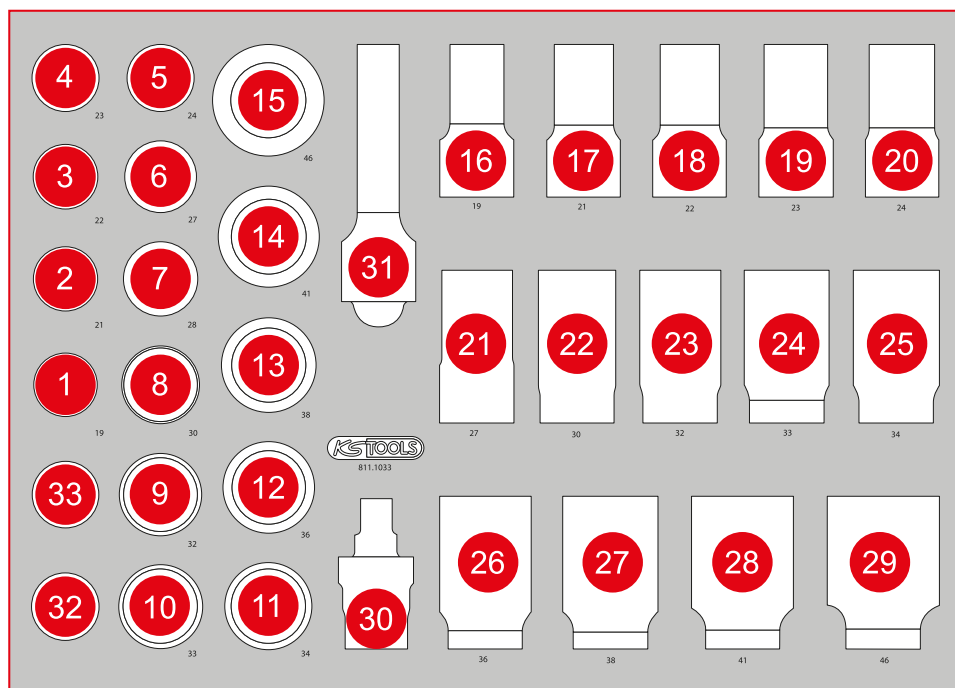

P35

873.5008-R014P

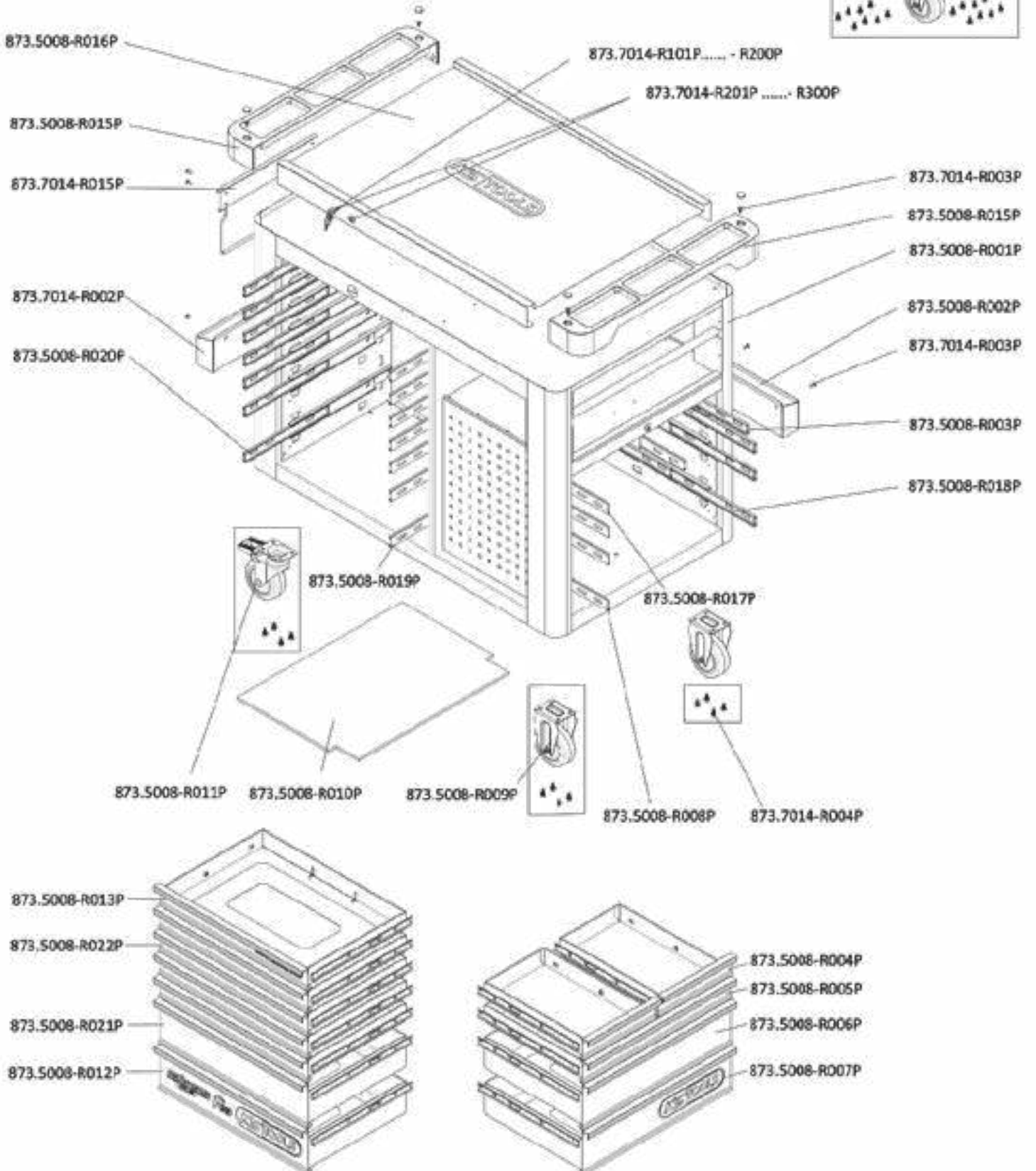
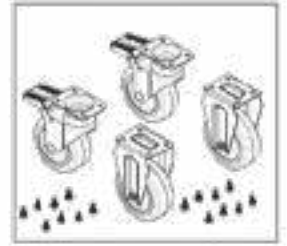



INDIVIDUAL PARTS LIST

Art.-Nr.	Description	amount
873.7014-R101P...	Replacement key for PERFORMANCEplus workshop trolley lock number xyz	2
873.7014-R201P...	Lock with 2 keys for PERFORMANCEplus workshop trolley lock number xyz	2
873.5008-R001P	Body with handle	1
873.5008-R002P	Can holder for PERFORMANCEplus workshop trolley P10/P15/P25/P35	1
873.5008-R003P	Full extension (with ball-bearing guide) with automatic retraction	2
873.5008-R004P	Compartment with ball-bearing guide, 268x398x65 mm	2
873.5008-R005P	Compartment with ball-bearing guide, 568x398x65 mm	1
873.5008-R006P	Compartment with ball-bearing guide, 568x398x145 mm	1
873.5008-R007P	Compartment with logo and ball-bearing guide, 568x398x145 mm	1
873.5008-R008P	Full extension (with ball-bearing guide) with automatic retraction	3
873.5008-R009P	Fixed castors for PERFORMANCEplus workshop trolley, incl. screws	2
873.5008-R010P	Foam support	1
873.5008-R011P	Swivel castors with brakes, for PERFORMANCEplus workshop trolley, incl. screws	2
873.5008-R012P	Compartment with logo and ball-bearing guide, 568x398x145 mm	1
873.5008-R013P	Compartment with website and ball-bearing guide, 568x398x65 mm	1
873.5008-R014P	Roller set for PERFORMANCEplus workshop trolley, incl. screws	1
873.5008-R015P	Storage for work surface	2
873.5008-R016P	Stainless steel work surface	1
873.5008-R017P	Full extension (with ball-bearing guide) with automatic retraction	2
873.5008-R018P	Full extension (with ball-bearing guide) with automatic retraction	3
873.5008-R019P	Full extension (with ball-bearing guide) with automatic retraction	7
873.5008-R020P	Full extension (with ball-bearing guide) with automatic retraction	7
873.5008-R021P	Compartment with ball-bearing guide, 568x398x145 mm	1
873.5008-R022P	Compartment with ball-bearing guide, 568x398x65 mm	4
873.7014-R002P	Can holder for PERFORMANCEplus workshop trolley P20/P30/P35/P40/P45	1
873.7014-R003P	M6x12 screw (1 pcs.) for PERFORMANCEplus workshop trolley accessories	12
873.7014-R004P	M8 screws for PERFORMANCEplus workshop trolley rollers (16 pcs.)	1
873.7014-R015P	Paper roll holder for PERFORMANCEplus workshop trolley P20/P30/P35/P40/P45	1

P35

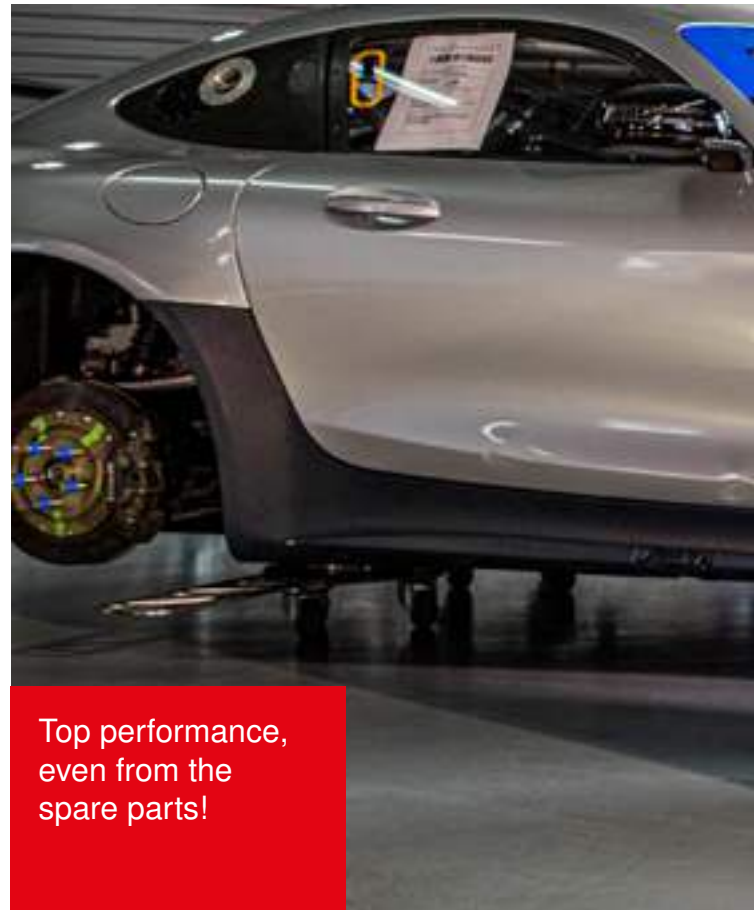

Top performance,
even from the
spare parts!



873.7014-R101P...R200P
Replacement key for lock number xyz



873.7014-R201P...R300P
Lock with 2 keys, lock number xyz



873.5008-R003P
Full extension (with ball-bearing guide) with automatic retraction, right



873.5008-R008P
Full extension with self-closing for drawer, left



873.5008-R019P
Full extension with self-closing for drawer, right



873.5008-R020P
Full extension with self-closing for drawer, left



873.5008-R018P
Full extension with self-closing for drawer, right



873.5008-R017P
Full extension with self-closing for drawer, left



873.5008-R009P
Fixed castors, incl. screws



873.5008-R011P
Swivel castors with brakes, incl. screws

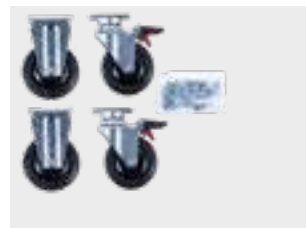

873.5008-R014P
Roller set, incl. screws



873.5008-R016P
Stainless steel work surface



873.5008-R010P
Foam support, 8 mm



873.5008-R015P
Storage for work surface, including screw cover, usable on both sides



873.5008-R013P
Compartment with website and ball-bearing guide, 568x398x65 mm



873.5008-R005P
Compartment with ball-bearing guide, 568x398x65 mm



873.5008-R006P
Compartment with ball-bearing guide, 568x398x145 mm



873.5008-R012P
Compartment with logo and ball-bearing guide, 568x398x145 mm



873.5008-R004P
Compartment with ball-bearing guide, 268x398x65 mm



873.5008-R022P
Compartment with ball-bearing guide, 568x398x65 mm



873.5008-R021P
Compartment with ball-bearing guide, 568x398x145 mm



873.5008-R007P
Compartment with logo and ball-bearing guide, 568x398x145 mm



873.5008-R002P
Can holder including screws, W = 310 mm



873.7014-R002P
Can holder including screws, W = 445 mm



873.7014-R015P
Paper roll holder including screws, W = 400 mm



873.7014-R004P
M8 screws (16 pcs.)



873.7014-R003P
M6x12 screw (1 pcs.)



873.5008-R001P
Body of workshop trolley attachment