

P45

workshop tool trolley
with 950 tools for 13 drawers
845.14950

THE SPACESHIP OF YOUR DREAMS FOR THE WORKSHOP!

P45



Workshop trolley P45
with 14 compartments
873.7014



DUO Lock Brilliant locking system



Fourteen drawers each load capacity up to 65 kg



Stable **ball bearing**

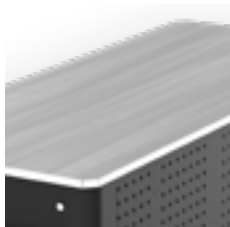

Stainless steel surface



Lock lockable



Anti-static castors with brakes



Integrated **corner protection**



Paper roll holder included



Can holder included

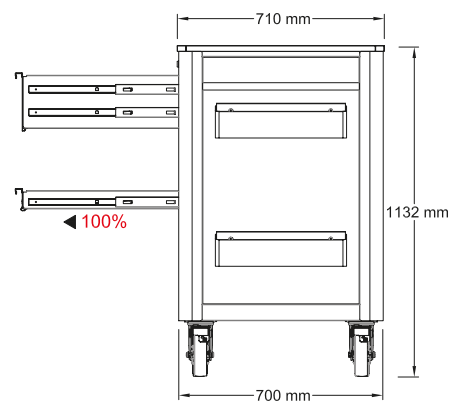
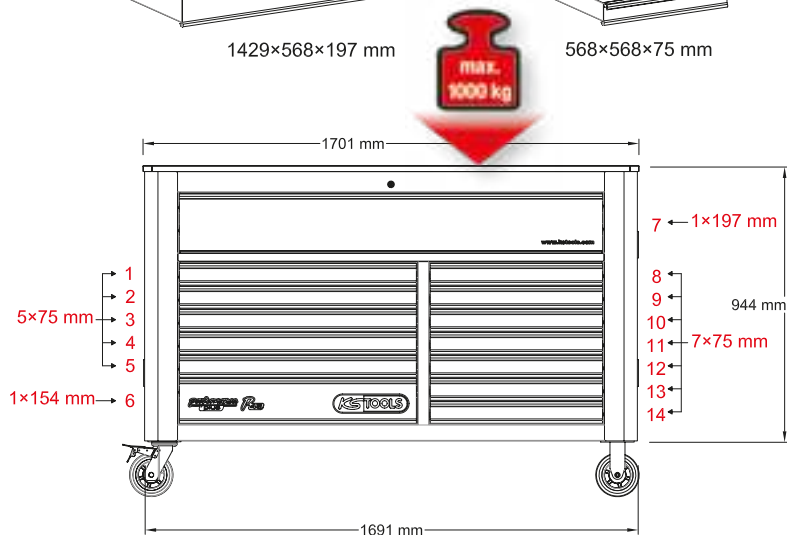
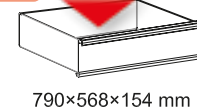
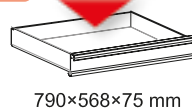
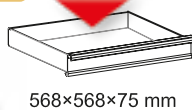
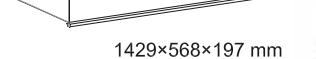
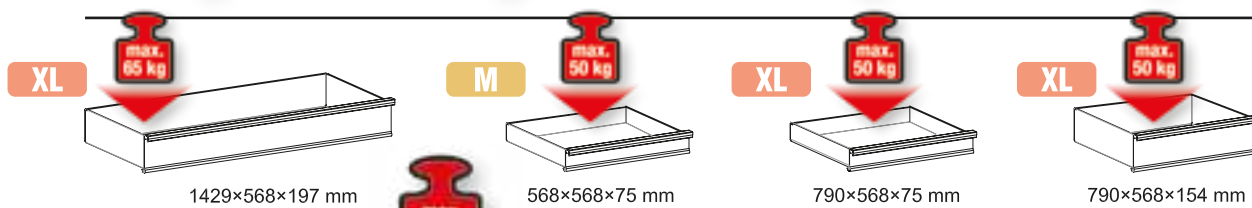

P45 workshop tool trolley set with 950 tools for 13 drawers [1 | 2]

845.14950



PCS
950

XL

1 2 3 4 5

M

6 7 8 9 10 11 12 13 14

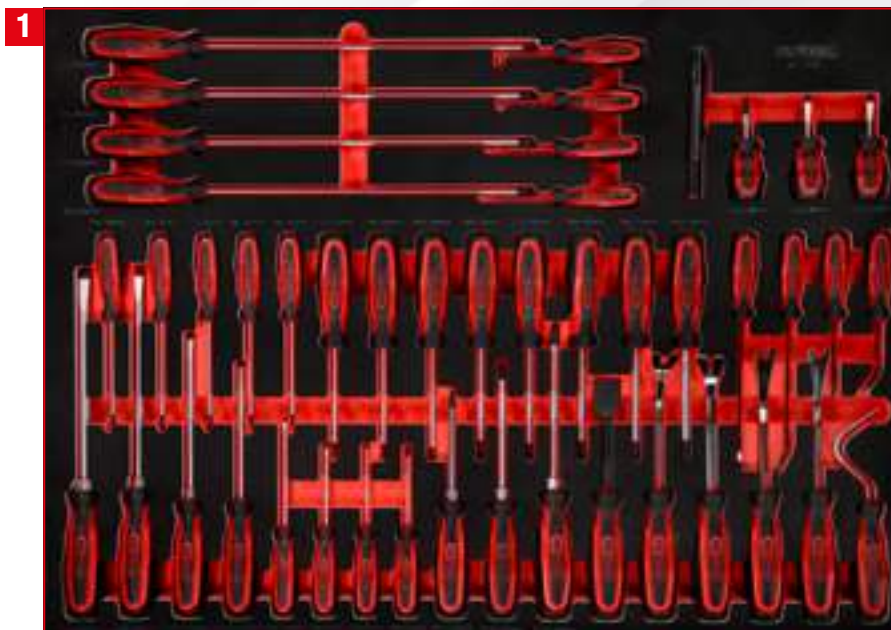

PCS
46

Screwdriver set in foam insert

821.0046

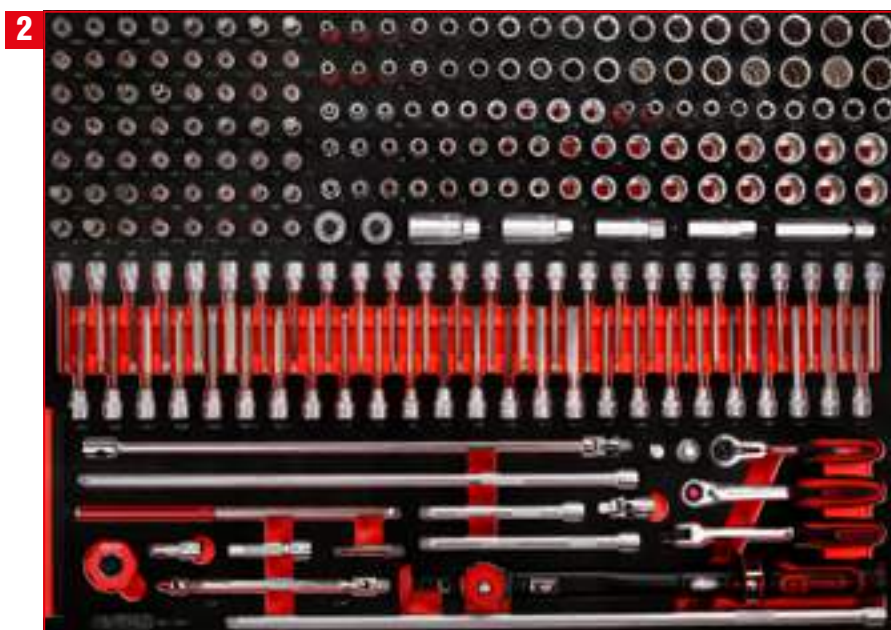

PCS
221

3/8" socket spanner set in foam insert

821.0221



PCS
149

1/2" socket spanner set in foam insert

821.0149



PCS
76

Screw spanner set in foam insert

821.0076



PCS
34

Spanner set in foam insert

821.0034

P45 workshop tool trolley set with 950 tools for 13 drawers [2 | 2]

845.14950



950

XL

1 2 3 4 5

M

6 7 8 9 10 11 12 13 14



6

1/2" impact socket set in foam insert

811.0039

39

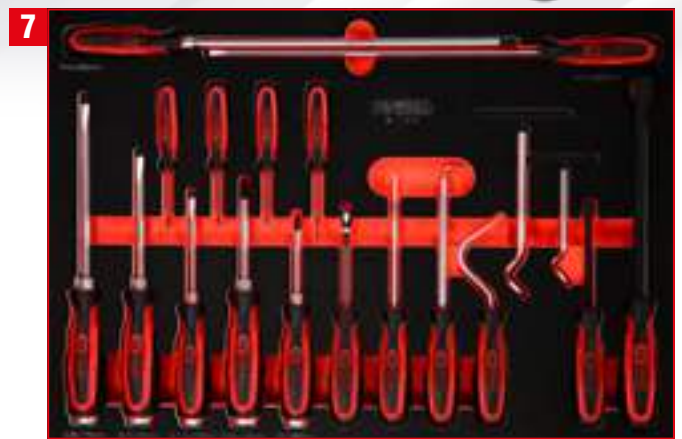

7

Screwdriver and hook set in foam insert

811.1019

19



8

Hammer and chisel set in foam insert

811.0020

20



9

1/4" socket spanner set in foam insert

811.0169

169



1/2" screwdriver bit set in foam insert

811.1064

64 PCS



Screw spanner set in foam insert

811.0049

49 PCS

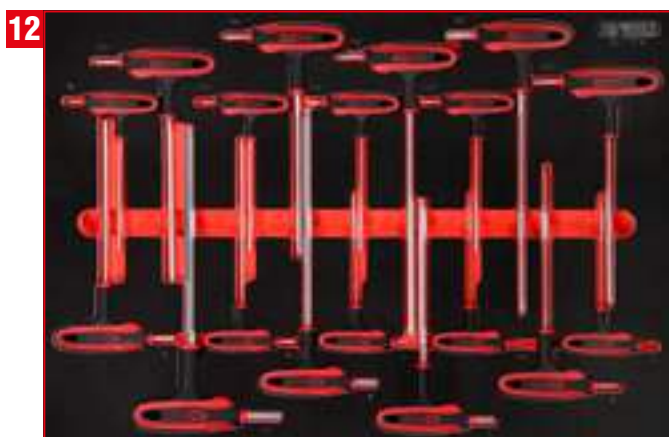

T-handle angle spanner set in foam insert

811.1018

18 PCS



T-handle angle spanner set in foam insert

811.2018

18 PCS



Measuring tool and file set in foam insert

811.0028

28 PCS

821.0046

XL Screwdriver set

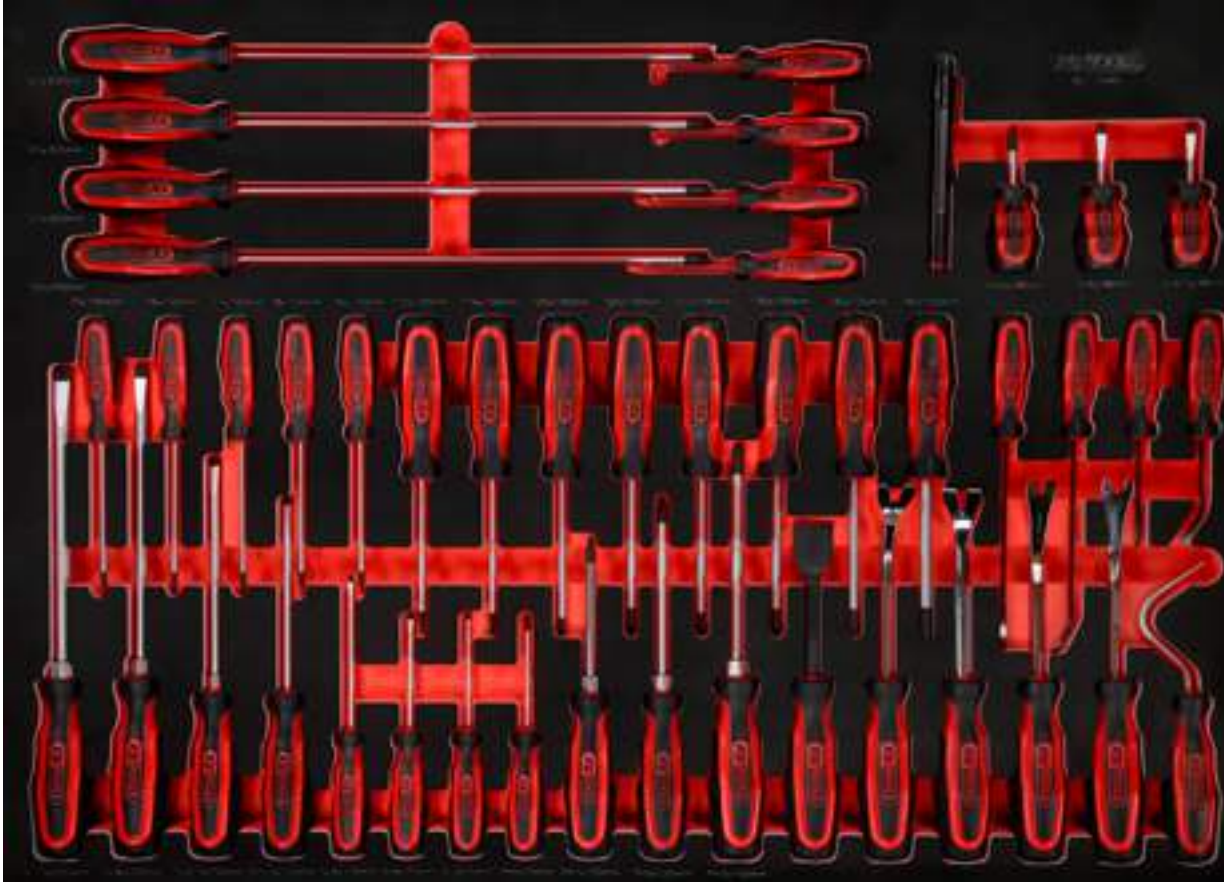

Pos.	Code	Description	pcs	Pos.	Code	Description	pcs	Pos.	Code	Description	pcs
1	159.1261	ERGOTORQUEplus screwdriver, Torx, T20, long	1	8	550.1046	Hook, straight	1	16	159.1030	ERGOTORQUEplus screwdriver, Torx, T8	1
2	159.1262	ERGOTORQUEplus screwdriver, Torx, T25, long	1	9	150.4370	perfectLight torch 85 lumen	1	17	159.1031	ERGOTORQUEplus screwdriver, Torx, T9	1
3	159.1263	ERGOTORQUEplus screwdriver, Torx, T27, long	1	10	159.1026	ERGOTORQUEplus screwdriver, Torx, short, PH2	1	18	159.1032	ERGOTORQUEplus screwdriver, Torx, T10	1
4	159.1264	ERGOTORQUEplus screwdriver, Torx, T30, long	1	11	159.1001	ERGOTORQUEplus screwdriver for slotted screws, short, 6 mm	1	19	159.1033	ERGOTORQUEplus screwdriver, Torx, T15	1
5	550.1048	Hook, 90° offset	1	12	159.1123	ERGOTORQUEplus screwdriver for slotted screws, short, 6,5 mm	1	20	159.1034	ERGOTORQUEplus screwdriver, Torx, T20	1
6	550.1049	Hook, 135° bent	1	13	159.1133	ERGOTORQUEplus screwdriver, Torx, T5	1	21	159.1035	ERGOTORQUEplus screwdriver, Torx, T25	1
7	550.1047	Hook, 45° offset	1	14	159.1134	ERGOTORQUEplus screwdriver, Torx, T6	1	22	159.1036	ERGOTORQUEplus screwdriver, Torx, T27	1
				15	159.1135	ERGOTORQUEplus screwdriver, Torx, T7	1	23	159.1037	ERGOTORQUEplus screwdriver, Torx, T30	1
								24	159.1038	ERGOTORQUEplus screwdriver, Torx, T40	1
								25	159.1136	ERGOTORQUEplus screwdriver, Torx, T45	1

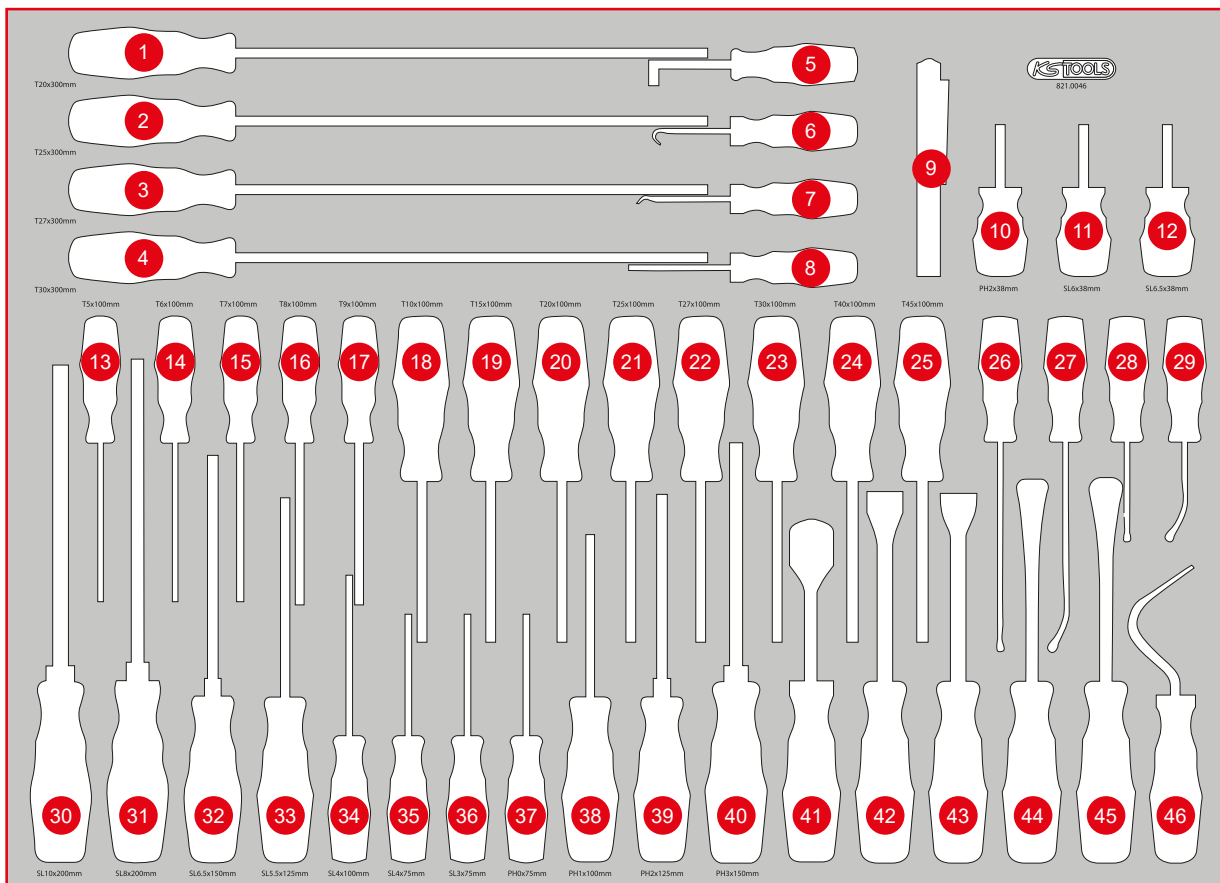

Pos.	Code	Description	pcs	Pos.	Code	Description	pcs	Pos.	Code	Description	pcs
26	140.2612	Panel lever 3 x 133 mm	1	34	159.1004	ERGOTORQUEplus screwdriver for slotted screws, 4 mm, 180 mm long	1	40	159.1024	ERGOTORQUEplus screwdriver, Torx, PH3, 265 mm	1
27	140.2614	Panel lever 3 x 133 mm, bent	1	35	159.1003	ERGOTORQUEplus screwdriver for slotted screws, 4 mm, 155 mm long	1	41	907.2232	Gasket scraper, 25 x 200 mm	1
28	140.2611	Panel lever 3 x 63 mm	1	36	159.1002	ERGOTORQUEplus screwdriver for slotted screws, 3 mm, 155 mm long	1	42	140.2616	Clip remover, short 7,5 mm	1
29	140.2613	Panel lever 3 x 63 mm, bent	1	37	159.1027	ERGOTORQUEplus screwdriver, Torx, PH0, 155 mm	1	43	140.2615	Clip remover, short 9 mm	1
30	159.1012	ERGOTORQUEplus screwdriver for slotted screws, 10 mm, 315 mm long	1	38	159.1029	ERGOTORQUEplus screwdriver, Torx, PH1, 205 mm	1	44	140.2371	Clip remover short, length 245 mm, opening 4 mm	1
31	159.1011	ERGOTORQUEplus screwdriver for slotted screws, 8 mm, 315 mm long	1	39	159.1022	ERGOTORQUEplus screwdriver, Torx, PH2, 230 mm	1	45	140.2373	Clip remover short, length 245 mm, opening 10 mm	1
32	159.1009	ERGOTORQUEplus screwdriver for slotted screws, 6,5 mm, 255 mm long	1					46	550.1073	Hook, large, sickle	1
33	159.1006	ERGOTORQUEplus screwdriver for slotted screws, 5,5 mm, 230 mm long	1								

XL 3/8" Socket spanner set

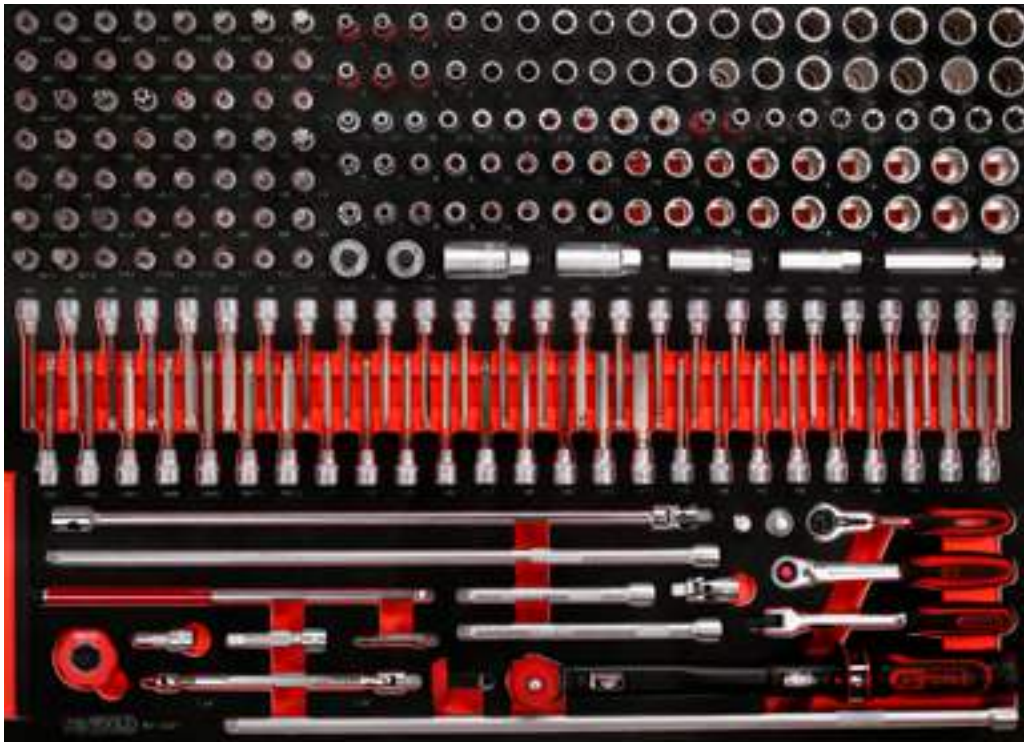

790 x 568



P20



P30



P45

Pos.	Code	Description	pcs	Pos.	Code	Description	pcs	Pos.	Code	Description	pcs
1	917.3921	3/8" RIBE® Bit socket, M4	1	39	911.3868	3/8" Bit socket hexagon, 8 mm	1	77	917.3856	3/8" 12 Point socket, deep, 9 mm	1
2	917.3922	3/8" RIBE® Bit socket, M5	1	40	917.3969	3/8" Bit socket hexagon, 9 mm	1	78	917.3970	3/8" 12 Point socket, deep, 10 mm	1
3	917.3923	3/8" RIBE® Bit socket, M6	1	41	917.3857	3/8" Bit socket hexagon, 10 mm	1	79	917.3971	3/8" 12 Point socket, deep, 11 mm	1
4	917.3924	3/8" RIBE® Bit socket, M7	1	42	917.3992	3/8" Bit socket hexagon, 11 mm	1	80	917.3972	3/8" 12 Point socket, deep, 12 mm	1
5	917.3925	3/8" RIBE® Bit socket, M8	1	43	911.3862	3/8" Bit socket hexagon, 12 mm	1	81	917.3973	3/8" 12 Point socket, deep, 13 mm	1
6	917.3926	3/8" RIBE® Bit socket, M9	1	44	911.3918	3/8" Bit socket spline (XZN), M4	1	82	917.3974	3/8" 12 Point socket, deep, 14 mm	1
7	917.3927	3/8" RIBE® Bit socket, M10	1	45	911.3915	3/8" Bit socket spline (XZN), M5	1	83	917.3975	3/8" 12 Point socket, deep, 15 mm	1
8	917.3928	3/8" RIBE® Bit socket, M12	1	46	911.3916	3/8" Bit socket spline (XZN), M6	1	84	917.3976	3/8" 12 Point socket, deep, 16 mm	1
9	917.3929	3/8" Bit socket Torx tamperproof, TB 8	1	47	911.3917	3/8" Bit socket spline (XZN), M8	1	85	917.3977	3/8" 12 Point socket, deep, 17 mm	1
10	911.3960	3/8" Bit socket Torx tamperproof, TB 10	1	48	917.3901	3/9" Bit socket spline (XZN), M9	1	86	917.3978	3/8" 12 Point socket, deep, 18 mm	1
11	911.3961	3/8" Bit socket Torx tamperproof, TB 15	1	49	911.3920	3/8" Bit socket spline (XZN), M10	1	87	917.3979	3/8" 12 Point socket, deep, 19 mm	1
12	911.3962	3/8" Bit socket Torx tamperproof, TB 20	1	50	917.3903	3/12" Bit socket spline (XZN), M12	1	88	917.3980	3/8" 12 Point socket, deep, 20 mm	1
13	911.3963	3/8" Bit socket Torx tamperproof, TB 25	1	51	911.3875	3/8" Bit socket, PH1	1	89	917.3981	3/8" 12 Point socket, deep, 21 mm	1
14	911.3964	3/8" Bit socket Torx tamperproof, TB 27	1	52	911.3876	3/8" Bit socket, PH2	1	90	917.3882	3/8" 12 Point socket, deep, 22 mm	1
15	911.3965	3/8" Bit socket Torx tamperproof, TB 30	1	53	911.3877	3/8" Bit socket, PH3	1	91	911.4340	3/8" Torx E Socket, E6	1
16	911.3966	3/8" Bit socket Torx tamperproof, TB 40	1	54	911.3881	3/8" Bit socket, PZ1	1	92	911.4341	3/8" Torx E Socket, E7	1
17	911.3967	3/8" Bit socket Torx tamperproof, TB 45	1	55	911.3882	3/8" Bit socket, PZ2	1	93	911.4342	3/8" Torx E Socket, E8	1
18	911.3968	3/8" Bit socket Torx tamperproof, TB 50	1	56	911.3883	3/8" Bit socket, PZ3	1	94	911.4318	3/8" Torx E Socket, E10	1
19	911.3969	3/8" Bit socket Torx tamperproof, TB 55	1	57	917.4806	3/8" Hexagonal socket, deep, 6 mm	1	95	911.4319	3/8" Torx E Socket, E11	1
20	911.3970	3/8" Bit socket Torx tamperproof, TB 60	1	58	917.4807	3/8" Hexagonal socket, deep, 7 mm	1	96	911.4320	3/8" Torx E Socket, E12	1
21	911.3934	3/8" Bit socket Torx, T8	1	59	917.3828	3/8" Hexagonal socket, deep, 8 mm	1	97	911.4321	3/8" Torx E Socket, E14	1
22	911.3887	3/8" Bit socket Torx, T10	1	60	917.3829	3/8" Hexagonal socket, deep, 9 mm	1	98	911.4343	3/8" Torx E Socket, E16	1
23	911.3869	3/8" Bit socket Torx, T15	1	61	917.3830	3/8" Hexagonal socket, deep, 10 mm	1	99	911.4344	3/8" Torx E Socket, E18	1
24	911.3870	3/8" Bit socket Torx, T20	1	62	917.3831	3/8" Hexagonal socket, deep, 11 mm	1	100	911.4345	3/8" Torx E Socket, E20	1
25	911.3871	3/8" Bit socket Torx, T25	1	63	917.3832	3/8" Hexagonal socket, deep, 12 mm	1	101	911.4386	3/8" Torx E Socket, E6, long	1
26	911.3872	3/8" Bit socket Torx, T27	1	64	917.3833	3/8" Hexagonal socket, deep, 13 mm	1	102	911.4387	3/8" Torx E Socket, E7, long	1
27	911.3873	3/8" Bit socket Torx, T30	1	65	917.3834	3/8" Hexagonal socket, deep, 14 mm	1	103	911.4388	3/8" Torx E Socket, E8, long	1
28	911.3874	3/8" Bit socket Torx, T40	1	66	917.3835	3/8" Hexagonal socket, deep, 15 mm	1	104	911.4390	3/8" Torx E Socket, E10, long	1
29	911.3885	3/8" Bit socket Torx, T45	1	67	917.3836	3/8" Hexagonal socket, deep, 16 mm	1	105	911.4391	3/8" Torx E Socket, E11, long	1
30	911.3884	3/8" Bit socket Torx, T50	1	68	917.3837	3/8" Hexagonal socket, deep, 17 mm	1	106	911.4392	3/8" Torx E Socket, E12, long	1
31	911.3888	3/8" Bit socket Torx, T55	1	69	917.3838	3/8" Hexagonal socket, deep, 18 mm	1	107	911.4394	3/8" Torx E Socket, E14, long	1
32	911.3889	3/8" Bit socket Torx, T60	1	70	917.3839	3/8" Hexagonal socket, deep, 19 mm	1	108	911.4396	3/8" Torx E Socket, E16, long	1
33	911.3863	3/8" Bit socket hexagon, 3 mm	1	71	917.3840	3/8" Hexagonal socket, deep, 20 mm	1	109	911.4398	3/8" Torx E Socket, E18, long	1
34	911.3864	3/8" Bit socket hexagon, 4 mm	1	72	917.3841	3/8" Hexagonal socket, deep, 21 mm	1	110	911.4399	3/8" Torx E Socket, E20, long	1
35	911.3865	3/8" Bit socket hexagon, 5 mm	1	73	917.3842	3/8" Hexagonal socket, deep, 22 mm	1	111	917.3806	3/8" Hexagonal socket, 6 mm	1
36	911.38655	3/8" Bit socket hexagon, 5, 5 mm	1	74	917.4831	3/8" 12 Point socket, deep, 6 mm	1	112	917.3807	3/8" Hexagonal socket, 7 mm	1
37	911.3866	3/8" Bit socket hexagon, 6 mm	1	75	917.4832	3/8" 12 Point socket, deep, 7 mm	1	113	917.3808	3/8" Hexagonal socket, 8 mm	1
38	911.3867	3/8" Bit socket hexagon, 7 mm	1	76	917.3855	3/8" 12 Point socket, deep, 8 mm	1	114	917.3809	3/8" Hexagonal socket, 9 mm	1

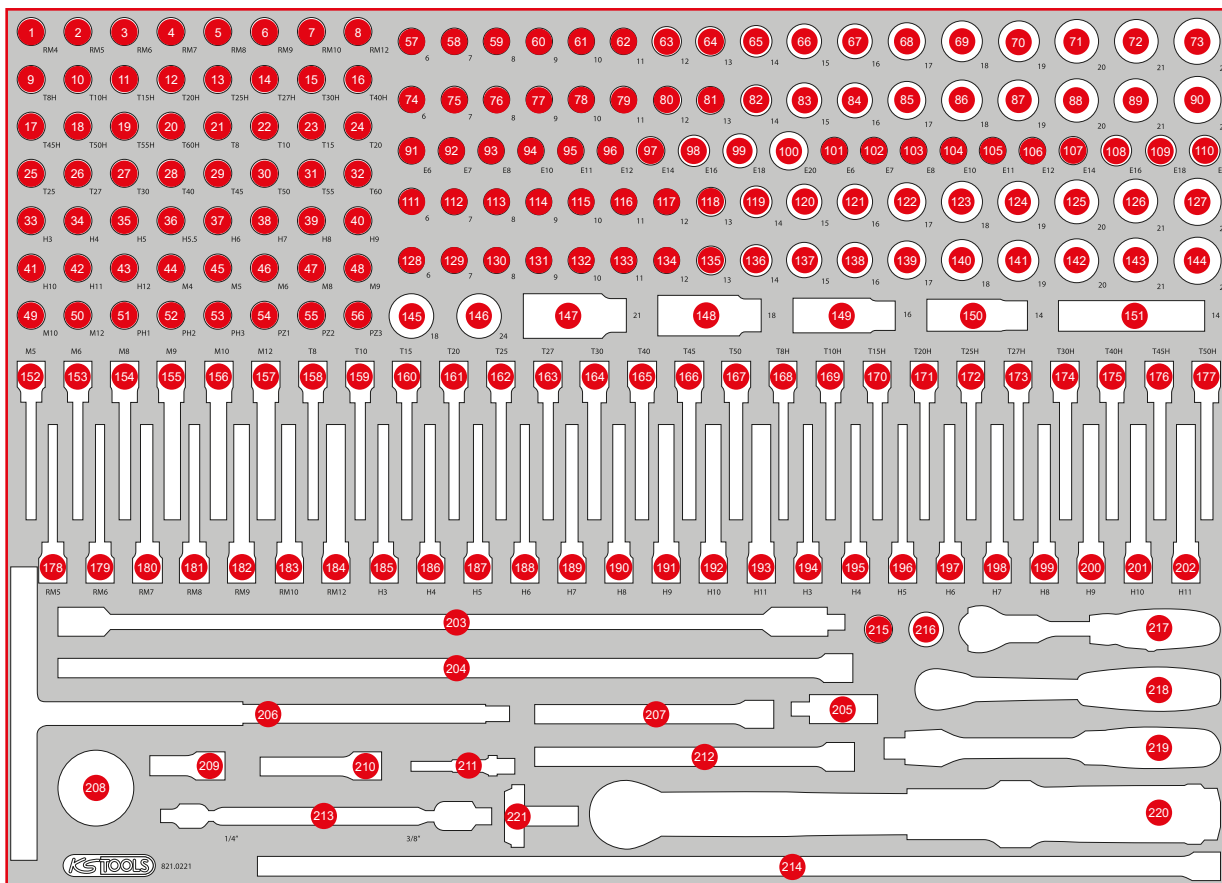

Pos.	Code	Description	pcs	Pos.	Code	Description	pcs	Pos.	Code	Description	pcs
115	917.3810	3/8" Hexagonal socket, 10 mm	1	152	917.3904	XZN spline bit socket, 3/8", M5, long	1	190	911.1565	3/8" Bit socket hexagon, long, 8 mm	1
116	917.3811	3/8" Hexagonal socket, 11 mm	1	153	917.3905	XZN spline bit socket, 3/8", M6, long	1	191	917.1594	3/8" Bit socket hexagon, long, 9 mm	1
117	917.3812	3/8" Hexagonal socket, 12 mm	1	154	917.3906	XZN spline bit socket, 3/8", M8, long	1	192	911.1566	3/8" Bit socket hexagon, long, 10 mm	1
118	917.3813	3/8" Hexagonal socket, 13 mm	1	155	917.3907	XZN spline bit socket, 3/8", M9, long	1	193	917.1595	3/8" Bit socket hexagon, long, 11 mm	1
119	917.3814	3/8" Hexagonal socket, 14 mm	1	156	917.3908	XZN spline bit socket, 3/8", M10, long	1	194	911.5393	Hex bit socket with ball end, 3/8", 3 mm	1
120	917.3815	3/8" Hexagonal socket, 15 mm	1	157	917.3909	XZN spline bit socket, 3/8", M12, long	1	195	911.5394	Hex bit socket with ball end, 3/8", 4 mm	1
121	917.3816	3/8" Hexagonal socket, 16 mm	1	158	917.1576	3/8" Bit socket Torx, long, T8	1	196	911.5395	Hex bit socket with ball end, 3/8", 5 mm	1
122	917.3817	3/8" Hexagonal socket, 17 mm	1	159	917.1577	3/8" Bit socket Torx, long, T10	1	197	911.5396	Hex bit socket with ball end, 3/8", 6 mm	1
123	917.3818	3/8" Hexagonal socket, 18 mm	1	160	917.1579	3/8" Bit socket Torx, long, T15	1	198	911.5397	Hex bit socket with ball end, 3/8", 7 mm	1
124	917.3819	3/8" Hexagonal socket, 19 mm	1	161	911.1551	3/8" Bit socket Torx, long, T20	1	199	911.5398	Hex bit socket with ball end, 3/8", 8 mm	1
125	917.3820	3/8" Hexagonal socket, 20 mm	1	162	911.1552	3/8" Bit socket Torx, long, T25	1	200	911.5399	Hex bit socket with ball end, 3/8", 9 mm	1
126	917.3821	3/8" Hexagonal socket, 21 mm	1	163	911.1553	3/8" Bit socket Torx, long, T27	1	201	911.5390	Hex bit socket with ball end, 3/8", 10 mm	1
127	917.3822	3/8" Hexagonal socket, 22 mm	1	164	911.1554	3/8" Bit socket Torx, long, T30	1	202	911.5391	Hex bit socket with ball end, 3/8", 11 mm	1
128	917.3804	3/8" 12 Point socket, 6 mm	1	165	911.1555	3/8" Bit socket Torx, long, T40	1	203	517.1126	T-Handle universal wrench for sockets, extra long, 3/8"	1
129	917.3805	3/8" 12 Point socket, 7 mm	1	166	911.1556	3/8" Bit socket Torx, long, T45	1	204	911.4884	3/8" Extensions 500 mm	1
130	911.3981	3/8" 12 Point socket, 8 mm	1	167	911.1557	3/8" Bit socket Torx, long, T50	1	205	911.3850	3/8" Universal joint	1
131	911.3982	3/8" 12 Point socket, 9 mm	1	168	917.3938	3/8" Bit socket Torx tamperproof, long, TB 8	1	206	911.3931	3/8" T-Handle-Spinner	1
132	911.3983	3/8" 12 Point socket, 10 mm	1	169	917.3937	3/8" Bit socket Torx tamperproof, long, TB 10	1	207	911.3802	3/8" Extensions 150 mm	1
133	911.3984	3/8" 12 Point socket, 11 mm	1	170	911.3939	3/8" Bit socket Torx tamperproof, long, TB 15	1	208	914.3810	3/8" HandReversible ratchet	1
134	911.3985	3/8" 12 Point socket, 12 mm	1	171	911.3971	3/8" Bit socket Torx tamperproof, long, TB 20	1	209	911.3852	3/8" Extensions 45 mm	1
135	911.3986	3/8" 12 Point socket, 13 mm	1	172	911.3972	3/8" Bit socket Torx tamperproof, long, TB 25	1	210	911.3801	3/8" Extensions 75 mm	1
136	911.3987	3/8" 12 Point socket, 14 mm	1	173	911.3973	3/8" Bit socket Torx tamperproof, long, TB 27	1	211	514.1107	Socket adaptor, 1/4"x3/8"	1
137	911.3988	3/8" 12 Point socket, 15 mm	1	174	911.3974	3/8" Bit socket Torx tamperproof, long, TB 30	1	212	911.3856	3/8" Extensions 200 mm	1
138	911.3989	3/8" 12 Point socket, 16 mm	1	175	911.3975	3/8" Bit socket Torx tamperproof, long, TB 40	1	213	517.0338	Double-joint-spanner for 1/4" and 3/8" sockets	1
139	911.3992	3/8" 12 Point socket, 17 mm	1	176	911.3976	3/8" Bit socket Torx tamperproof, long, TB 45	1	214	911.4892	3/8" Extensions 600 mm	1
140	911.3993	3/8" 12 Point socket, 18 mm	1	177	911.3977	3/8" Bit socket Torx tamperproof, long, TB 50	1	215	911.3892	Adaptor, 3/8" Fx1/2" M	1
141	911.3994	3/8" 12 Point socket, 19 mm	1	178	917.3930	3/8" RIBE® Bit socket, long, M5	1	216	911.1233	Reducing adaptor, 1/2" F x 3/8" M	1
142	917.4811	3/8" 12 Point socket, 20 mm	1	179	917.3931	3/8" RIBE® Bit socket, long, M6	1	217	914.3815	3/8" MODIFIX mini T-handle swivel head ratchet, 72 teeth, 0° +90°	1
143	911.3996	3/8" 12 Point socket, 21 mm	1	180	917.3932	3/8" RIBE® Bit socket, long, M7	1	218	920.3890	3/8" SlimPOWER Reversible ratchet, 72 teeth	1
144	911.3997	3/8" 12 Point socket, 22 mm	1	181	917.3933	3/8" RIBE® Bit socket, long, M8	1	219	917.3939	3/8" Flexi head drive handle	1
145	516.1501	Torque limiter for spark plugs, 3/8", 18Nm	1	182	917.3934	3/8" RIBE® Bit socket, long, M9	1	220	516.1432	1/2" ERGOTORQUE® precision torque wrench with rotary mushroom ratchet head, 20-100Nm	1
146	516.1502	Torque limiter for spark plugs, 3/8", 24Nm	1	183	917.3935	3/8" RIBE® Bit socket, long, M10	1	221	516.1428	Rotary square box wrench, 1/2"x3/8"	1
147	911.3805	3/8" Spark plug socket, 21 mm	1	184	917.3936	3/8" RIBE® Bit socket, long, M12	1				
148	911.3823	3/8" Spark plug socket, 18 mm	1	185	917.1593	3/8" Bit socket hexagon, long, 3 mm	1				
149	911.3804	3/8" Spark plug socket, 16 mm	1	186	911.1561	3/8" Bit socket hexagon, long, 4 mm	1				
150	911.3990	3/8" Spark plug socket, 14 mm	1	187	911.1562	3/8" Bit socket hexagon, long, 5 mm	1				
151	911.3999	3/8" Special spark plug socket for BMW with flexible joint, 14 mm	1	188	911.1563	3/8" Bit socket hexagon, long, 6 mm	1				
				189	911.1564	3/8" Bit socket hexagon, long, 7 mm	1				

XL 1/2" Socket spanner set



Pos.	Code	Description	pcs	Pos.	Code	Description	pcs	Pos.	Code	Description	pcs
1	911.1304	1/2" Bit socket hexagon, short, 4 mm	1	28	911.1343	1/2" Bit socket spline (XZN), M10, 55 mm	1	54	917.1316	1/2" Bit socket hexagon, short, 3/16"	1
2	911.1305	1/2" Bit socket hexagon, short, 5 mm	1	29	911.1344	1/2" Bit socket spline (XZN), M12, 55 mm	1	55	917.1318	1/2" Bit socket hexagon, short, 1/4"	1
3	911.13055	1/2" Bit socket hexagon, short, 5,5 mm	1	30	911.1345	1/2" Bit socket spline (XZN), M14, 55 mm	1	56	917.1319	1/2" Bit socket hexagon, short, 9/32"	1
4	911.1306	1/2" Bit socket hexagon, short, 6 mm	1	31	911.1346	1/2" Bit socket spline (XZN), M16, 55 mm	1	57	917.1320	1/2" Bit socket hexagon, short, 5/16"	1
5	911.1307	1/2" Bit socket hexagon, short, 7 mm	1	32	911.5306	1/2" Bit socket spline (XZN), M17, 55 mm	1	58	911.5386	1/2" Bit socket hexagon, short, 11/32"	1
6	911.1308	1/2" Bit socket hexagon, short, 8 mm	1	33	911.1348	1/2" Bit socket spline (XZN) tamperproof, M16, 55 mm	1	59	917.1321	1/2" Bit socket hexagon, short, 3/8"	1
7	911.1309	1/2" Bit socket hexagon, short, 9 mm	1	34	911.1361	1/2" Bit socket Torx, T20	1	60	911.5387	1/2" Bit socket hexagon, short, 7/16"	1
8	911.1310	1/2" Bit socket hexagon, short, 10 mm	1	35	911.1362	1/2" Bit socket Torx, T25	1	61	917.1322	1/2" Bit socket hexagon, short, 1/2"	1
9	911.1312	1/2" Bit socket hexagon, short, 12 mm	1	36	911.1363	1/2" Bit socket Torx, T27	1	62	917.1323	1/2" Bit socket hexagon, short, 9/16"	1
10	911.1314	1/2" Bit socket hexagon, short, 14 mm	1	37	911.1364	1/2" Bit socket Torx, T30	1	63	917.1324	1/2" Bit socket hexagon, short, 5/8"	1
11	911.1317	1/2" Bit socket hexagon, short, 17 mm	1	38	911.1365	1/2" Bit socket Torx, T40	1	64	911.1581	1/2" 12 Point socket, 21 mm	1
12	911.1319	1/2" Bit socket hexagon, short, 19 mm	1	39	911.1366	1/2" Bit socket Torx, T45	1	65	911.1582	1/2" 12 Point socket, 22 mm	1
13	911.4511	Bit socket for RIBE screws, M5, length 55 mm	1	40	911.1367	1/2" Bit socket Torx, T50	1	66	911.1583	1/2" 12 Point socket, 23 mm	1
14	911.4512	Bit socket for RIBE screws, M6, length 55 mm	1	41	911.1368	1/2" Bit socket Torx, T55	1	67	911.1584	1/2" 12 Point socket, 24 mm	1
15	911.4513	Bit socket for RIBE screws, M7, length 55 mm	1	42	911.1369	1/2" Bit socket Torx, T60	1	68	917.1364	1/2" 12 Point socket, 26 mm	1
16	911.4514	Bit socket for RIBE screws, M8, length 55 mm	1	43	911.1370	1/2" Bit socket Torx, T70	1	69	911.1585	1/2" 12 Point socket, 27 mm	1
17	911.4515	Bit socket for RIBE screws, M9, length 55 mm	1	44	911.1371	1/2" Bit socket Torx tamperproof, TB20	1	70	917.1365	1/2" 12 Point socket, 28 mm	1
18	911.4516	Bit socket for RIBE screws, M10, length 55 mm	1	45	911.1372	1/2" Bit socket Torx tamperproof, TB25	1	71	911.1586	1/2" 12 Point socket, 30 mm	1
19	911.4551	Bit socket for RIBE screws, M10.1, length 55 mm	1	46	911.1373	1/2" Bit socket Torx tamperproof, TB27	1	72	911.1587	1/2" 12 Point socket, 32 mm	1
20	911.4517	Bit socket for RIBE screws, M12, length 55 mm	1	47	911.1374	1/2" Bit socket Torx tamperproof, TB30	1	73	911.1570	1/2" 12 Point socket, 10 mm	1
21	911.4518	Bit socket for RIBE screws, M13, length 55 mm	1	48	911.1375	1/2" Bit socket Torx tamperproof, TB40	1	74	911.1571	1/2" 12 Point socket, 11 mm	1
22	911.4519	Bit socket for RIBE screws, M14, length 55 mm	1	49	911.1376	1/2" Bit socket Torx tamperproof, TB45	1	75	911.1572	1/2" 12 Point socket, 12 mm	1
23	911.4552	Bit socket for RIBE screws, M16, length 55 mm	1	50	911.1377	1/2" Bit socket Torx tamperproof, TB50	1	76	911.1573	1/2" 12 Point socket, 13 mm	1
24	911.1340	1/2" Bit socket spline (XZN), M5, 55 mm	1	51	911.1378	1/2" Bit socket Torx tamperproof, TB55	1	77	911.1574	1/2" 12 Point socket, 14 mm	1
25	911.1341	1/2" Bit socket spline (XZN), M6, 55 mm	1	52	911.1379	1/2" Bit socket Torx tamperproof, TB60	1	78	911.1575	1/2" 12 Point socket, 15 mm	1
26	911.1342	1/2" Bit socket spline (XZN), M8, 55 mm	1	53	911.1380	1/2" Bit socket Torx tamperproof, TB70	1	79	911.1576	1/2" 12 Point socket, 16 mm	1
27	911.1313	1/2" Bit socket spline (XZN), M9, 55 mm	1					80	911.1577	1/2" 12 Point socket, 17 mm	1

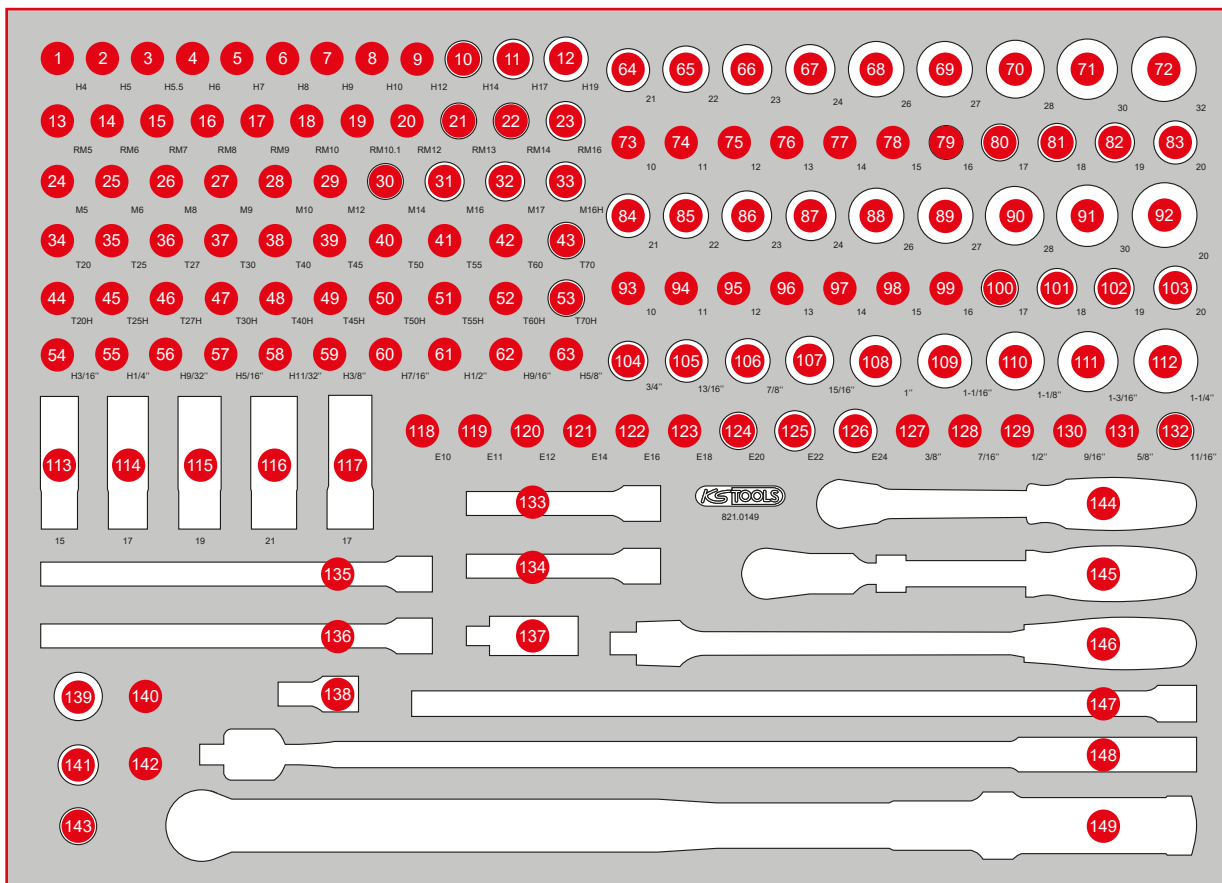

Pos.	Code	Description	pcs	Pos.	Code	Description	pcs	Pos.	Code	Description	pcs
81	911.1578	1/2" 12 Point socket, 18 mm	1	108	917.1383	1/2" 12 Point socket, 1"	1	134	911.1383	Wobble extension, 1/2", 125 mm	1
82	911.1579	1/2" 12 Point socket, 19 mm	1	109	917.1384	1/2" 12 Point socket, 1.1/16"	1	135	911.1203	1/2" Extensions, 250 mm	1
83	911.1580	1/2" 12 Point socket, 20 mm	1	110	917.1385	1/2" 12 Point socket, 1.1/8"	1	136	911.1384	Wobble extension, 1/2", 250 mm	1
84	917.1221	1/2" Hexagonal socket, 21 mm	1	111	917.1386	1/2" 12 Point socket, 1.3/16"	1	137	911.1250	1/2" Universal joint	1
85	917.1222	1/2" Hexagonal socket, 22 mm	1	112	917.1387	1/2" 12 Point socket, 1.1/4"	1	138	911.1381	Wobble extension, 1/2", 50 mm	1
86	917.1223	1/2" Hexagonal socket, 23 mm	1	113	515.0991	SlimPOWER 1/2" Alloy rim impact socket, 15 mm	1	139	911.3412	Reducing adaptor 3/4" F x 1/2" M	1
87	917.1224	1/2" Hexagonal socket, 24 mm	1	114	515.0992	SlimPOWER 1/2" Alloy rim impact socket, 17 mm	1	140	911.1233	Reducing adaptor, 1/2" F x 3/8" M	1
88	917.1343	1/2" Hexagonal socket, 26 mm	1	115	515.0993	SlimPOWER 1/2" Alloy rim impact socket, 19 mm	1	141	911.1234	Adaptor, 1/2" F x 3/4" M	1
89	917.1227	1/2" Hexagonal socket, 27 mm	1	116	515.0994	SlimPOWER 1/2" Alloy rim impact socket, 21 mm	1	142	911.3892	Adaptor, 3/8" F x 1/2" M	1
90	917.1344	1/2" Hexagonal socket, 28 mm	1	117	515.2055	Special aluminium rims special profile impact socket for Mercedes, long, 17 mm	1	143	911.1207	3/8" Sliding adaptor, 3/8" F x 1/2" M	1
91	917.1230	1/2" Hexagonal socket, 30 mm	1	118	911.4333	1/2" Torx E Socket, E10	1	144	920.1290	1/2" SlimPOWER Reversible ratchet, 72 teeth	1
92	917.1232	1/2" Hexagonal socket, 32 mm	1	119	911.4334	1/2" Torx E Socket, E11	1	145	914.1220	1/2" SlimPOWER Telescopic reversible ratchet, 72 teeth	1
93	917.1210	1/2" Hexagonal socket, 10 mm	1	120	911.4335	1/2" Torx E Socket, E12	1	146	917.1455	1/2" Flexi head drive handle	1
94	917.1211	1/2" Hexagonal socket, 11 mm	1	121	911.4336	1/2" Torx E Socket, E14	1	147	911.1836	Wobble extension, 1/2", 500 mm	1
95	917.1212	1/2" Hexagonal socket, 12 mm	1	122	911.4322	1/2" Torx E Socket, E16	1	148	918.1292	1/2" CHROMEplus Flexi head drive handle, 600 mm	1
96	917.1213	1/2" Hexagonal socket, 13 mm	1	123	911.4323	1/2" Torx E Socket, E18	1	149	516.1482	1/2" ERGOTORQUE® precision torque wrench with rotary mushroom ratchet head, 80-420Nm	1
97	917.1214	1/2" Hexagonal socket, 14 mm	1	124	911.4324	1/2" Torx E Socket, E20	1				
98	917.1215	1/2" Hexagonal socket, 15 mm	1	125	911.4325	1/2" Torx E Socket, E22	1				
99	917.1216	1/2" Hexagonal socket, 16 mm	1	126	911.4326	1/2" Torx E Socket, E24	1				
100	917.1217	1/2" Hexagonal socket, 17 mm	1	127	917.1370	1/2" 12 Point socket, 3/8"	1				
101	917.1218	1/2" Hexagonal socket, 18 mm	1	128	917.1372	1/2" 12 Point socket, 7/16"	1				
102	917.1219	1/2" Hexagonal socket, 19 mm	1	129	917.1373	1/2" 12 Point socket, 1/2"	1				
103	917.1220	1/2" Hexagonal socket, 20 mm	1	130	917.1374	1/2" 12 Point socket, 9/16"	1				
104	917.1378	1/2" 12 Point socket, 3/4"	1	131	917.1376	1/2" 12 Point socket, 5/8"	1				
105	917.1380	1/2" 12 Point socket, 13/16"	1	132	917.1377	1/2" 12 Point socket, 11/16"	1				
106	917.1381	1/2" 12 Point socket, 7/8"	1	133	911.1202	1/2" Extensions, 125 mm	1				
107	917.1382	1/2" 12 Point socket, 15/16"	1								

821.0076

XL Screw spanner set



Pos.	Code	Description	pcs	Pos.	Code	Description	pcs	Pos.	Code	Description	pcs
1	517.0813	Double ring spanner, offset, 20 x 22 mm	1	16	503.4618	GEARplus reversing combination ratcheting spanner, 18 mm	1	26	503.4608	GEARplus reversing combination ratcheting spanner, 8 mm	1
2	517.0812	Double ring spanner, offset, 18 x 19 mm	1	17	503.4617	GEARplus reversing combination ratcheting spanner, 17 mm	1	27	503.4290	GEARplus bit adaptor, 1/4" x 10 mm	1
3	517.0810	Double ring spanner, offset, 16 x 17 mm	1	18	503.4616	GEARplus reversing combination ratcheting spanner, 16 mm	1	28	503.4296	GEARplus socket adaptor, 1/4" x 10 mm	1
4	517.0809	Double ring spanner, offset, 14 x 15 mm	1	19	503.4615	GEARplus reversing combination ratcheting spanner, 15 mm	1	29	503.4297	GEARplus socket adaptor, 3/8" x 13 mm	1
5	517.0807	Double ring spanner, offset, 12 x 13 mm	1	20	503.4614	GEARplus reversing combination ratcheting spanner, 14 mm	1	30	503.4298	GEARplus socket adaptor, 1/2" x 19 mm	1
6	517.0804	Double ring spanner, offset, 10 x 11 mm	1	21	503.4613	GEARplus reversing combination ratcheting spanner, 13 mm	1	31	518.0017	CHROMEplus Combination spanner, stubby, 17 mm	1
7	517.0802	Double ring spanner, offset, 8 x 9 mm	1	22	503.4612	GEARplus reversing combination ratcheting spanner, 12 mm	1	32	518.0016	CHROMEplus Combination spanner, stubby, 16 mm	1
8	517.0801	Double ring spanner, offset, 6 x 7 mm	1	23	503.4611	GEARplus reversing combination ratcheting spanner, 11 mm	1	33	518.0015	CHROMEplus Combination spanner, stubby, 15 mm	1
9	518.0528	Open double ring spanner, with double joint, 10 x 11	1	24	503.4610	GEARplus reversing combination ratcheting spanner, 10 mm	1	34	518.0014	CHROMEplus Combination spanner, stubby, 14 mm	1
10	517.0252	Open double ring spanner, offset, 8 x 10 mm	1	25	503.4609	GEARplus reversing combination ratcheting spanner, 9 mm	1	35	518.0013	CHROMEplus Combination spanner, stubby, 13 mm	1
11	517.9244	Open double ring spanner, offset, 11 x 13 mm	1					36	518.0012	CHROMEplus Combination spanner, stubby, 12 mm	1
12	517.0258	Open double ring spanner, offset, 12 x 14 mm	1								
13	517.0263	Open double ring spanner, offset, 16 x 18 mm	1								
14	517.0264	Open double ring spanner, offset, 17 x 19 mm	1								
15	503.4619	GEARplus reversing combination ratcheting spanner, 19 mm	1								

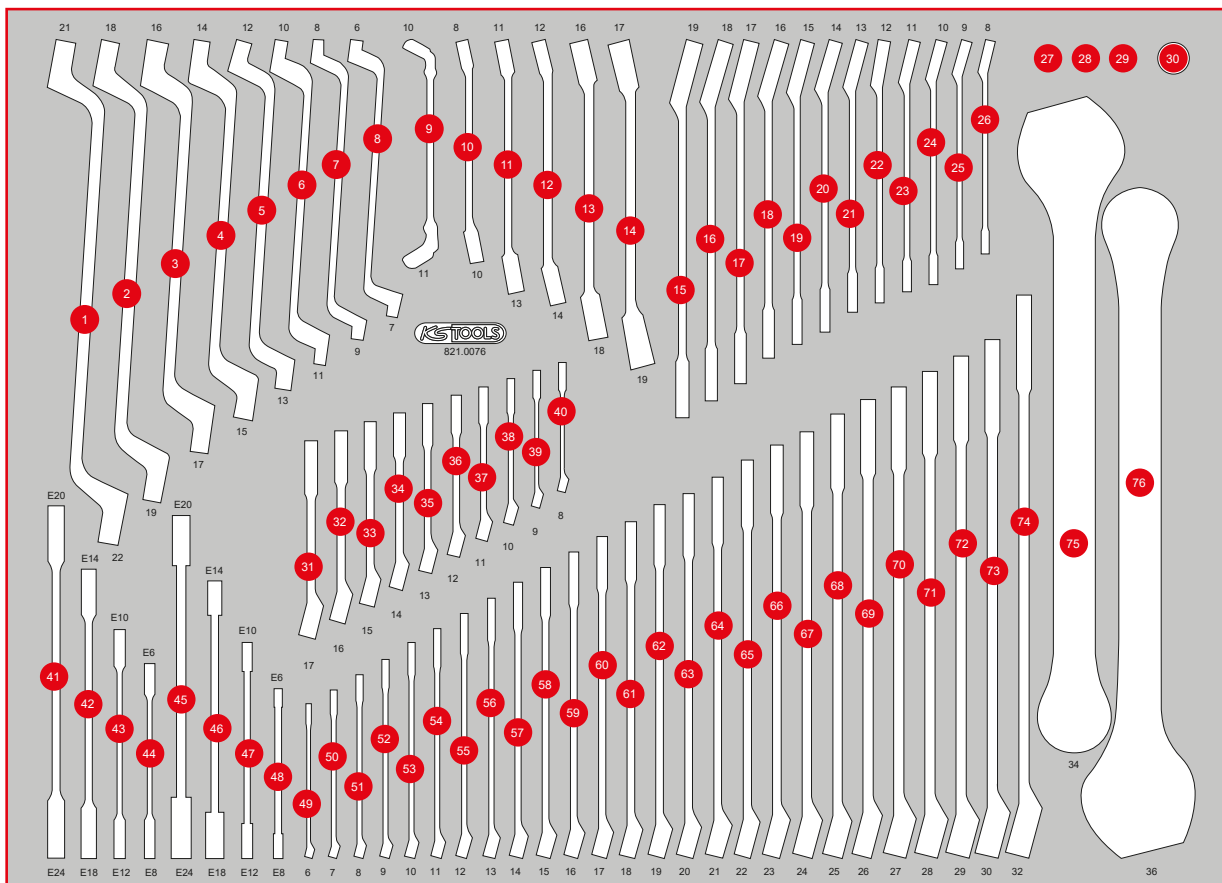

Pos.	Code	Description	pcs	Pos.	Code	Description	pcs	Pos.	Code	Description	pcs
37	518.0011	CHROMEplus Combination spanner, stubby, 11 mm	1	49	517.0606	Combination spanners, offset, 6 mm	1	66	517.0623	Combination spanners, offset, 23 mm	1
38	518.0010	CHROMEplus Combination spanner, stubby, 10 mm	1	50	517.0607	Combination spanners, offset, 7 mm	1	67	517.0624	Combination spanners, offset, 24 mm	1
39	518.0008	CHROMEplus Combination spanner, stubby, 9 mm	1	51	517.0608	Combination spanners, offset, 8 mm	1	68	517.0625	Combination spanners, offset, 25 mm	1
40	518.0007	CHROMEplus Combination spanner, stubby, 8 mm	1	52	517.0609	Combination spanners, offset, 9 mm	1	69	517.0626	Combination spanners, offset, 26 mm	1
41	503.4357	GEARplus Double ring ratchet spanner, E20 x E24	1	53	517.0610	Combination spanners, offset, 10 mm	1	70	517.0627	Combination spanners, offset, 27 mm	1
42	503.4355	GEARplus Double ring ratchet spanner, E14 x E18	1	54	517.0611	Combination spanners, offset, 11 mm	1	71	517.0628	Combination spanners, offset, 28 mm	1
43	503.4353	GEARplus Double ring ratchet spanner, E10 x E12	1	55	517.0612	Combination spanners, offset, 12 mm	1	72	517.0629	Combination spanners, offset, 29 mm	1
44	503.4351	GEARplus Double ring ratchet spanner, E6 x E8	1	56	517.0613	Combination spanners, offset, 13 mm	1	73	517.0630	Combination spanners, offset, 30 mm	1
45	911.0376	Double ring spanner for Torx E profile, E20 x E24	1	57	517.0614	Combination spanners, offset, 14 mm	1	74	517.0632	Combination spanners, offset, 32 mm	1
46	911.0374	Double ring spanner for Torx E profile, E14 x E18	1	58	517.0615	Combination spanners, offset, 15 mm	1	75	517.0634	Combination spanners, offset, 34 mm	1
47	911.0373	Double ring spanner for Torx E profile, E10 x E12	1	59	517.0616	Combination spanners, offset, 16 mm	1	76	517.0636	Combination spanners, offset, 36 mm	1
48	911.0371	Double ring spanner for Torx E profile, E6 x E8	1	60	517.0617	Combination spanners, offset, 17 mm	1				
				61	517.0618	Combination spanners, offset, 18 mm	1				
				62	517.0619	Combination spanners, offset, 19 mm	1				
				63	517.0620	Combination spanners, offset, 20 mm	1				
				64	517.0621	Combination spanners, offset, 21 mm	1				
				65	517.0622	Combination spanners, offset, 22 mm	1				

821.0034

XL Spanner set

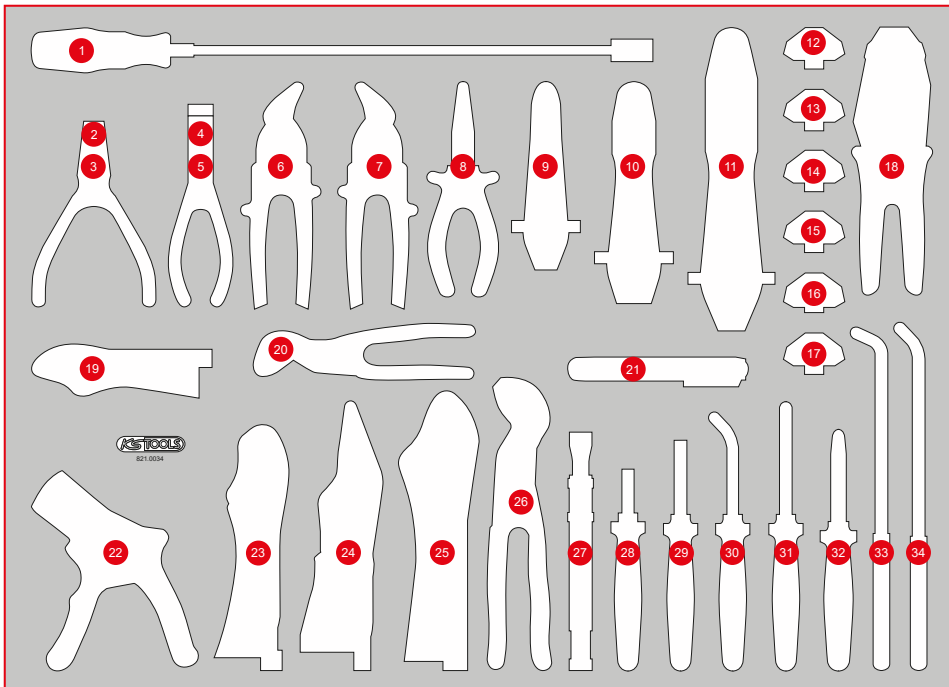

Pos.	Code	Description	pcs
1	550.1025	Flexible magnet lifter, 510 mm, Øhead=15 mm	1
2	500.1026	Circlip pliers for external circlips, angled, 160 mm	1
3	500.1029	Circlip pliers for external circlips, 160 mm	1
4	500.1032	Circlip pliers for internal circlips, angled, 160 mm	1
5	500.1035	Circlip pliers for internal circlips, 160 mm	1
6	118.0151	Mini metal shears, right handed cut	1
7	118.0153	Mini metal shears, left handed cut	1
8	115.1016	ERGOTORQUE flat pliers serrated, 160 mm	1
9	115.5052	Hose clamp gripper, Ø 15 mm	1
10	115.5053	Hose clamp gripper, Ø 30 mm	1
11	115.5054	Hose clamp gripper, Ø 60 mm	1
12	115.1415	Pair of crimp inserts for insulated cable lugs, Ø 0.5 - 6 mm	1
13	115.1416	Pair of crimp inserts for uninsulated cable lugs, Ø 0.5 - 10 mm	1
14	115.1417	Pair of crimp inserts for flat plugs 4.8 und 6.3 mm, Ø 0.5 - 6.0 mm	1
15	115.1418	Pair of crimp inserts for wire end ferrules, Ø 0.5 - 4 mm	1
16	115.1420	Crimp head for pin terminals	1
17	115.1421	Crimp head for non-insulated terminals	1
18	115.1401	Crimping tool	1
19	115.1031	Locking pliers, 50 mm, 140 mm	1
20	115.2011	Water pump pliers, 175 mm	1
21	150.2199	Brake fluid tester	1
22	115.1239	Self regulating wire stripper, 0,2-6 mm	1
23	115.1175	Round jaw-American type, 175 mm	1
24	115.2034	Long-nose locking pliers with quick-release lever, 45 mm, L=170 mm	1
25	115.1033	Self grip wrench, 220 mm	1
26	115.2010	Water pump pliers, 240 mm	1
27	115.1084	Welding self grip pliers, 195 mm	1
28	115.1012	ERGOTORQUE diagonal side cutter, 160 mm	1
29	115.1021	ERGOTORQUE combination pliers, 180 mm	1
30	115.1019	ERGOTORQUE bent nose pliers serrated, 210 mm	1
31	115.1024	ERGOTORQUE long nose pliers serrated cutter, 200 mm	1
32	115.1013	ERGOTORQUE power side cutter, 180 mm	1
33	500.7048	Sparkplug plier 12 mm	1
34	500.7052	Telephone pliers 45° curved, extra long, 270 mm	1

811.0039

M 1/2" impact socket set

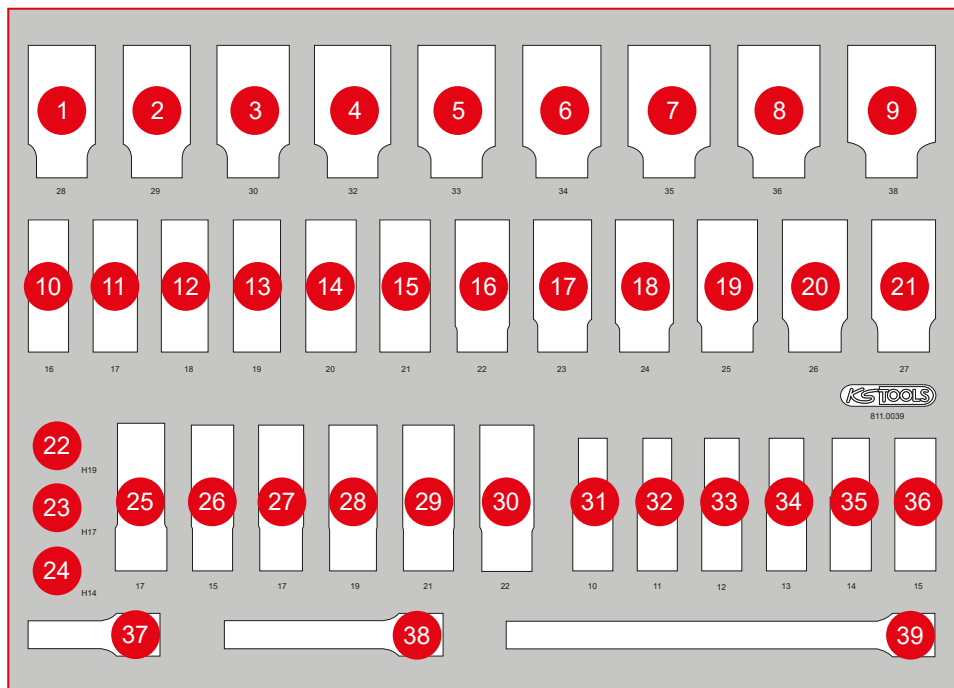

Pos.	Code	Description	pcs
1	515.1128	1/2" Hexagon impact socket, deep, 28 mm	1
2	515.1129	1/2" Hexagon impact socket, deep, 29 mm	1
3	515.1130	1/2" Hexagon impact socket, deep, 30 mm	1
4	515.1132	1/2" Hexagon impact socket, deep, 32 mm	1
5	515.1139	1/2" Hexagon impact socket, deep, 33 mm	1
6	515.1147	1/2" Hexagon impact socket, deep, 34 mm	1
7	515.1148	1/2" Hexagon impact socket, deep, 35 mm	1
8	515.1149	1/2" Hexagon impact socket, deep, 36 mm	1
9	515.1151	1/2" Hexagon impact socket, deep, 38 mm	1
10	515.1116	1/2" Hexagon impact socket, deep, 16 mm	1
11	515.1117	1/2" Hexagon impact socket, deep, 17 mm	1
12	515.1118	1/2" Hexagon impact socket, deep, 18 mm	1
13	515.1119	1/2" Hexagon impact socket, deep, 19 mm	1
14	515.1120	1/2" Hexagon impact socket, deep, 20 mm	1
15	515.1121	1/2" Hexagon impact socket, deep, 21 mm	1
16	515.1122	1/2" Hexagon impact socket, deep, 22 mm	1
17	515.1123	1/2" Hexagon impact socket, deep, 23 mm	1
18	515.1124	1/2" Hexagon impact socket, deep, 24 mm	1
19	515.1125	1/2" Hexagon impact socket, deep, 25 mm	1
20	515.1126	1/2" Hexagon impact socket, deep, 26 mm	1
21	515.1127	1/2" Hexagon impact socket, deep, 27 mm	1
22	911.0911	1/2" Impact bit socket, hexagon, short, 19 mm	1
23	911.0909	1/2" Impact bit socket, hexagon, short, 17 mm	1
24	911.0908	1/2" Impact bit socket, hexagon, short, 14 mm	1
25	515.2055	Special aluminium rims special profile impact socket for Mercedes, long, 17 mm	1
26	515.0991	SlimPOWER 1/2"Alloy rim impact socket, 15 mm	1
27	515.0992	SlimPOWER 1/2"Alloy rim impact socket, 17 mm	1
28	515.0993	SlimPOWER 1/2"Alloy rim impact socket, 19 mm	1
29	515.0994	SlimPOWER 1/2"Alloy rim impact socket, 21 mm	1
30	515.0995	SlimPOWER 1/2"Alloy rim impact socket, 22 mm	1
31	515.1110	1/2" Hexagon impact socket, deep, 10 mm	1
32	515.1111	1/2" Hexagon impact socket, deep, 11 mm	1
33	515.1112	1/2" Hexagon impact socket, deep, 12 mm	1
34	515.1113	1/2" Hexagon impact socket, deep, 13 mm	1
35	515.1114	1/2" Hexagon impact socket, deep, 14 mm	1
36	515.1115	1/2" Hexagon impact socket, deep, 15 mm	1
37	515.1134	1/2" Impact extension, 75 mm	1
38	515.1135	1/2" Impact extension, 125 mm	1
39	515.1136	1/2" Impact extension, 250 mm	1

811.1019

M Screwdriver and hook set

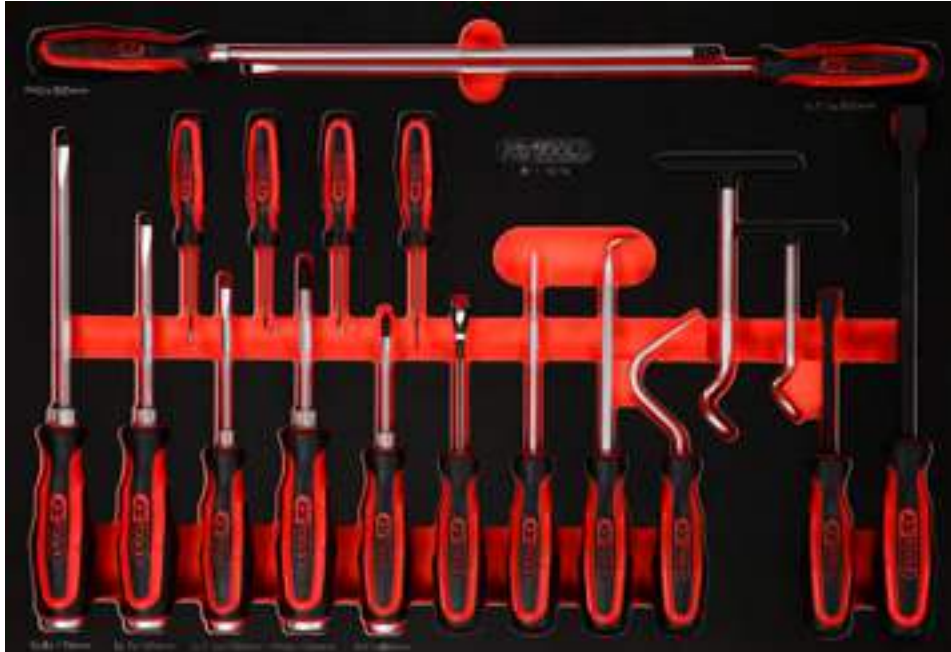

Pos.	Code	Description	pcs
1	159.1128	EERGOTORQUEplus screwdriver for phillips screws PH, extra long, PH2, 405 mm	1
2	159.1107	ERGOTORQUEplus screwdriver for slotted screws, extra long, 5,5 mm, 405 mm	1
3	550.1047	Hook, 45° offset	1
4	550.1049	Hook, 135° bent	1
5	550.1046	Hook, straight	1
6	550.1048	Hook, 90° offset	1
7	550.1075	T hook, S form large, 165 mm	1
8	550.1074	T hook, S form small, 120 mm	1
9	151.1133	ERGOTORQUEmax Hammer cap screwdriver slotted, 8 mm	1
10	151.1132	ERGOTORQUEmax Hammer cap screwdriver slotted, 7 mm	1
11	151.1128	ERGOTORQUEmax Hammer cap screwdriver slotted, 5,5 mm	1
12	151.1104	ERGOTORQUEmax Hammer cap screwdriver, PH2, 185 mm	1
13	151.1102	ERGOTORQUEmax Hammer cap screwdriver, PH1	1
14	140.2615	Clip remover short, length 240 mm, opening 9 mm	1
15	550.1071	Hook, large, straight	1
16	550.1072	Hook, large, 90° bent	1
17	550.1073	Hook, large, sickle	1
18	911.8101	Pry bar, 11 x 115 mm	1
19	911.8102	Pry bar, 15 x 185 mm	1

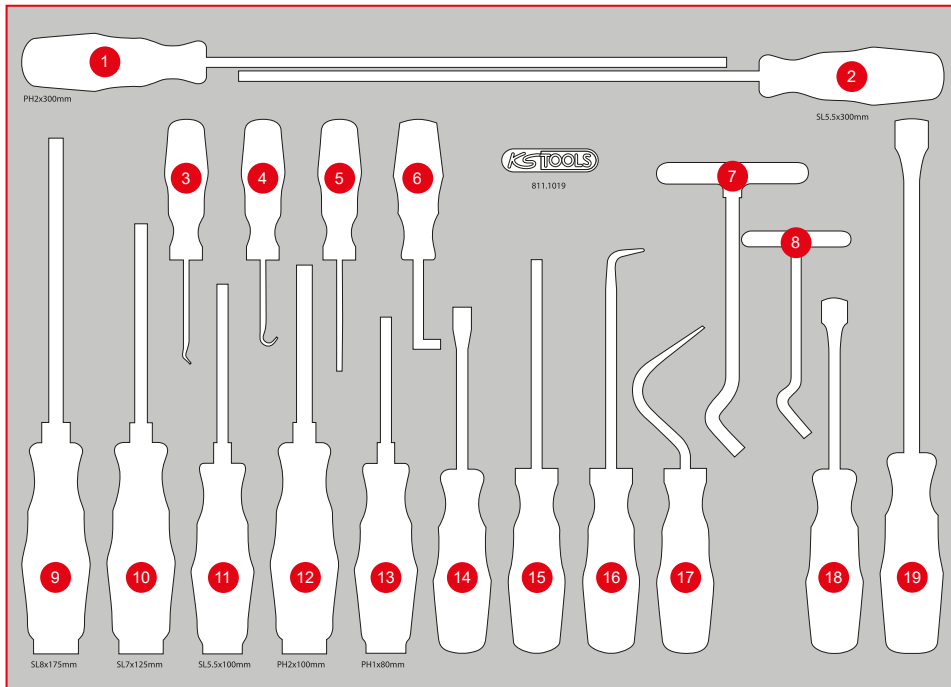

811.0020

M Hammer and chisel set



568 x 398



P10

P10TC

P15

P20

P30

P35

P45



Pos.	Code	Description	pcs
1	156.0236	Pin punch, Ø 2 mm, cylindrical shaft	1
2	156.0231	Pin punch, Ø 3 mm, cylindrical shaft	1
3	156.0232	Pin punch, Ø 4 mm, cylindrical shaft	1
4	156.0233	Pin punch, Ø 5 mm, cylindrical shaft	1
5	156.0234	Pin punch, Ø 6 mm, cylindrical shaft	1
6	156.0235	Pin punch, Ø 8 mm, cylindrical shaft	1
7	156.0237	Punch, Ø 3 mm, conical	1
8	156.0238	Punch, Ø 4 mm, conical	1
9	156.0244	Punch, Ø 5 mm, conical	1
10	156.0242	Cross chisel, octagon, 7 mm	1
11	156.0251	Flat chisel, octagon, 10 mm	1
12	156.0252	Flat chisel, octagon, 12 mm	1
13	156.0253	Flat chisel, octagon, 16 mm	1
14	156.0254	Flat chisel, octagon, 18 mm	1
15	156.0241	Flat chisel, octagon, 20 mm	1
16	140.5252	Recoil free soft faced Hammer, 400 g	1
17	142.1402	Fitters Hammer, fibreglas handle, 400 g	1
18	142.1321	Fitters Hammer, fibreglas handle, 200 g	1
19	140.5271	Recoil free soft faced Hammer, 480 g	1
20	142.5101	Club Hammer, fibreglas handle, 1000 g	1

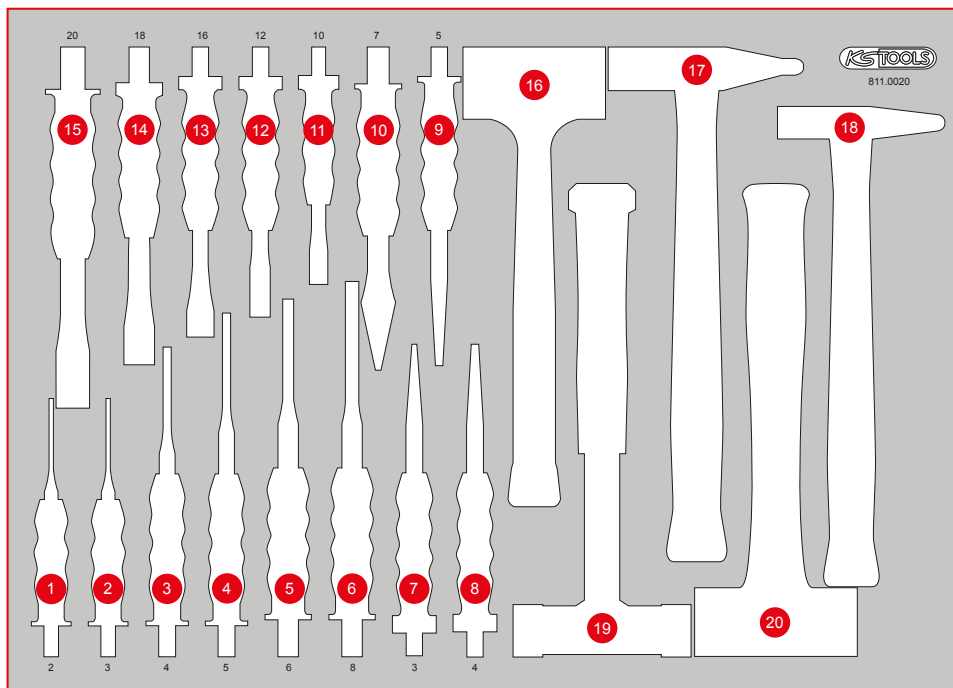

M 1/4" socket spanner set



Pos.	Code	Description	pcs	Pos.	Code	Description	pcs	Pos.	Code	Description	pcs
1	918.2414	Flex Socket TX E, 1/4", E5	1	30	917.2428	bi hex socket, uni joint, 1/4" 13 mm	1	59	911.1705	1/4" Bit socket five star tamperproof, TS27	1
2	918.2415	Flex Socket TX E, 1/4", E6	1	31	917.1604	1/4" 12 Point socket, deep, 4 mm	1	60	911.1706	1/4" Bit socket five star tamperproof, TS30	1
3	918.2416	Flex Socket TX E, 1/4", E7	1	32	917.16045	1/4" 12 Point socket, deep, 4,5 mm	1	61	911.1707	1/4" Bit socket five star tamperproof, TS40	1
4	918.2417	Flex Socket TX E, 1/4", E8	1	33	917.1605	1/4" 12 Point socket, deep, 5 mm	1	62	911.1708	1/4" Bit socket five star tamperproof, TS45	1
5	917.2401	1/4" Torx E Socket, deep, E4	1	34	917.16055	1/4" 12 Point socket, deep, 5,5 mm	1	63	911.1709	1/4" Bit socket five star tamperproof, TS50	1
6	917.2402	1/4" Torx E Socket, deep, E5	1	35	917.1606	1/4" 12 Point socket, deep, 6 mm	1	64	911.3772	1/4" Bit socket Torx, ball ended, T15	1
7	917.2403	1/4 Torx E Socket, deep E6	1	36	917.1607	1/4" 12 Point socket, deep, 7 mm	1	65	911.3773	1/4" Bit socket Torx, ball ended, T20	1
8	917.2404	1/4 Torx E Socket, deep E7	1	37	917.1608	1/4" 12 Point socket, deep, 8 mm	1	66	911.3774	1/4" Bit socket Torx, ball ended, T25	1
9	917.2405	1/4 Torx E Socket, deep E8	1	38	917.1609	1/4" 12 Point socket, deep, 9 mm	1	67	911.3775	1/4" Bit socket Torx, ball ended, T27	1
10	917.2406	1/4 Torx E Socket, deep E10	1	39	917.1610	1/4" 12 Point socket, deep, 10 mm	1	68	911.3776	1/4" Bit socket Torx, ball ended, T30	1
11	917.1525	1/4" Hexagonal socket, deep, 4 mm	1	40	917.1611	1/4" 12 Point socket, deep, 11 mm	1	69	911.3777	1/4" Bit socket Torx, ball ended, T40	1
12	917.1526	1/4" Hexagonal socket, deep, 4,5 mm	1	41	917.1612	1/4" 12 Point socket, deep, 12 mm	1	70	917.1456	TX bit socket tamperproof, 1/4", TB6	1
13	917.1527	1/4" Hexagonal socket, deep, 5 mm	1	42	917.1613	1/4" 12 Point socket, deep, 13 mm	1	71	917.1457	TX bit socket tamperproof, 1/4", TB7	1
14	917.1528	1/4" Hexagonal socket, deep, 5,5 mm	1	43	911.4407	1/4" Bit socket Torx, T6	1	72	911.1461	TX bit socket tamperproof, 1/4", TB8	1
15	917.1426	1/4" Hexagonal socket, deep, 6 mm	1	44	911.4362	1/4" Bit socket Torx, T7	1	73	911.1485	TX bit socket tamperproof, 1/4", TB9	1
16	917.1427	1/4" Hexagonal socket, deep, 7 mm	1	45	911.1448	1/4" Bit socket Torx, T8	1	74	911.1462	TX bit socket tamperproof, 1/4", TB10	1
17	917.1428	1/4" Hexagonal socket, deep, 8 mm	1	46	911.1478	1/4" Bit socket Torx, T9	1	75	911.1463	TX bit socket tamperproof, 1/4", TB15	1
18	917.1429	1/4" Hexagonal socket, deep, 9 mm	1	47	911.1442	1/4" Bit socket Torx, T10	1	76	911.1464	TX bit socket tamperproof, 1/4", TB20	1
19	917.1430	1/4" Hexagonal socket, deep, 10 mm	1	48	911.1443	1/4" Bit socket Torx, T15	1	77	911.1465	TX bit socket tamperproof, 1/4", TB25	1
20	917.1431	1/4" Hexagonal socket, deep, 11 mm	1	49	911.1444	1/4" Bit socket Torx, T20	1	78	911.1466	TX bit socket tamperproof, 1/4", TB27	1
21	917.1432	1/4" Hexagonal socket, deep, 12 mm	1	50	911.1445	1/4" Bit socket Torx, T25	1	79	911.1467	TX bit socket tamperproof, 1/4", TB30	1
22	917.1433	1/4" Hexagonal socket, deep, 13 mm	1	51	911.1449	1/4" Bit socket Torx, T27	1	80	911.1468	TX bit socket tamperproof, 1/4", TB40	1
23	917.2421	bi hex socket, uni joint, 1/4", 6 mm	1	52	911.1446	1/4" Bit socket Torx, T30	1	81	911.1482	1/4" Bit socket, PH0	1
24	917.2422	bi hex socket, uni joint, 1/4" 7 mm	1	53	911.1447	1/4" Bit socket Torx, T40	1	82	911.1415	1/4" Bit socket, PH1	1
25	917.2423	bi hex socket, uni joint, 1/4" 8 mm	1	54	917.1578	1/4" Torx Plus Bit-Socket 8IPR	1	83	911.1416	1/4" Bit socket, PH2	1
26	917.2424	bi hex socket, uni joint, 1/4" 9 mm	1	55	911.1701	1/4" Bit socket five star tamperproof, TS10	1	84	911.1417	1/4" Bit socket, PH3	1
27	917.2425	bi hex socket, uni joint, 1/4" 10 mm	1	56	911.1702	1/4" Bit socket five star tamperproof, TS15	1	85	911.1436	1/4" Bit socket hexagon, 3 mm	1
28	917.2426	bi hex socket, uni joint, 1/4" 11 mm	1	57	911.1703	1/4" Bit socket five star tamperproof, TS20	1	86	911.1437	1/4" Bit socket hexagon, 4 mm	1
29	917.2427	bi hex socket, uni joint, 1/4" 12 mm	1	58	911.1704	1/4" Bit socket five star tamperproof, TS25	1	87	911.1438	1/4" Bit socket hexagon, 5 mm	1

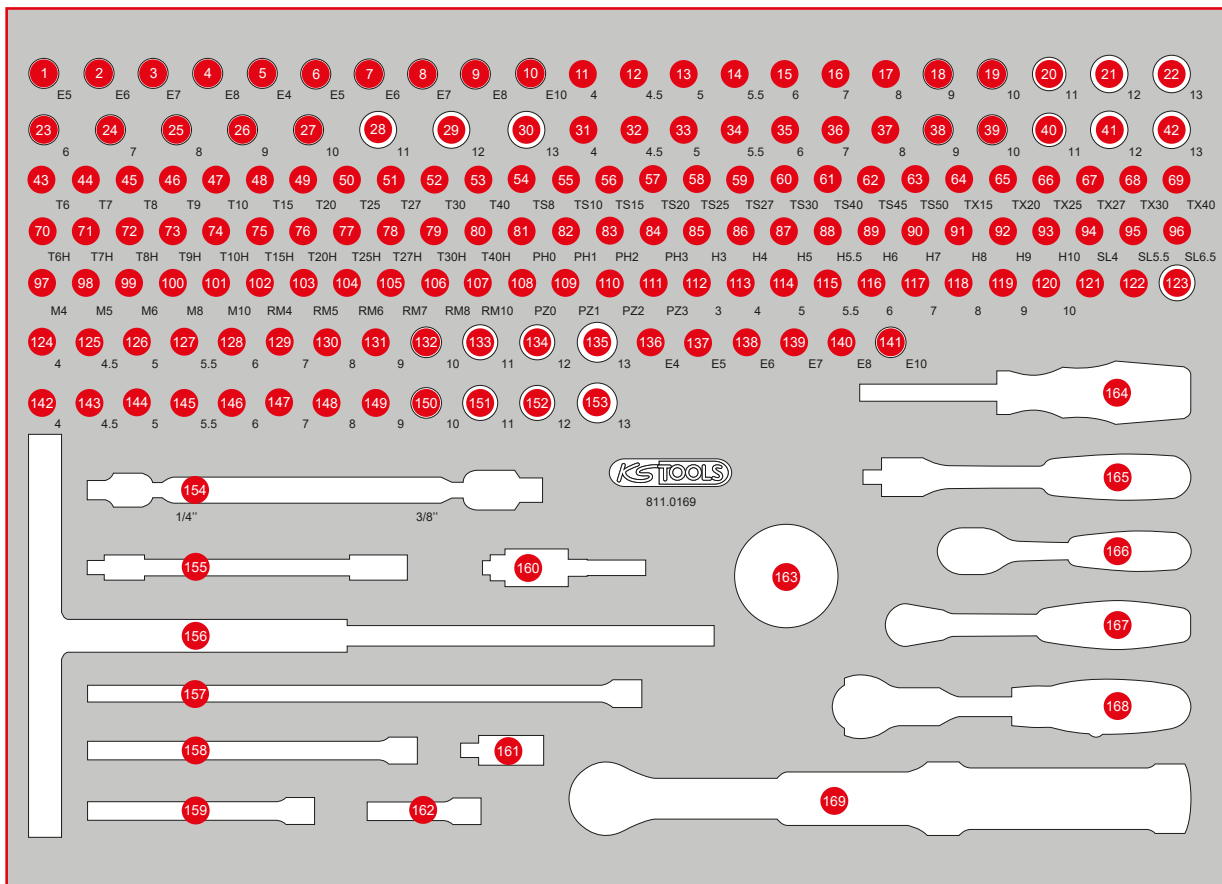

Pos.	Code	Description	pcs	Pos.	Code	Description	pcs	Pos.	Code	Description	pcs
88	911.14385	1/4" Bit socket hexagon, 5,5 mm	1	117	917.2447	1/4" Hex bit socket, ball ended, 1/4", 7 mm	1	146	917.1465	1/4" 12 Point socket, 6 mm	1
89	911.1439	1/4" Bit socket hexagon, 6 mm	1	118	917.2448	1/4" Hex bit socket, ball ended, 1/4", 8 mm	1	147	917.1466	1/4" 12 Point socket, 7 mm	1
90	911.1440	1/4" Bit socket hexagon, 7 mm	1	119	917.2449	1/4" Hex bit socket, ball ended, 1/4", 9 mm	1	148	917.1467	1/4" 12 Point socket, 8 mm	1
91	911.1441	1/4" Bit socket hexagon, 8 mm	1	120	917.2450	1/4" Hex bit socket, ball ended, 1/4", 10 mm	1	149	917.1468	1/4" 12 Point socket, 9 mm	1
92	917.1454	1/4" Bit socket hexagon, 9 mm	1	121	911.0101	1/4" socket with magnet	1	150	917.1469	1/4" 12 Point socket, 10 mm	1
93	917.1452	1/4" Bit socket hexagon, 10 mm	1	122	911.1494	Adaptor, 1/4" Mx3/8" F	1	151	917.1470	1/4" 12 Point socket, 11 mm	1
94	911.1418	1/4" Bit socket slot, 4 mm	1	123	911.3897	Reducing adaptor, 3/8" Fx1/4" M	1	152	917.1471	1/4" 12 Point socket, 12 mm	1
95	911.1419	1/4" Bit socket slot, 5,5 mm	1	124	917.1404	1/4" Hexagonal socket, 4 mm	1	153	917.1472	1/4" 12 Point socket, 13 mm	1
96	917.1421	1/4" Bit socket slot, 6,5 mm	1	125	917.14045	1/4" Hexagonal socket, 4,5 mm	1	154	517.0338	Double-joint-spanner for 1/4" and 3/8" sockets	1
97	917.1541	1/4" Bit socket spline (XZN), M4	1	126	917.1405	1/4" Hexagonal socket, 5 mm	1	155	911.1422	Extension, flexible, 1/4", 150 mm	1
98	917.1542	1/4" Bit socket spline (XZN), M5	1	127	917.14055	1/4" Hexagonal socket, 5,5 mm	1	156	911.2369	1/4" T-Handle-Spinner	1
99	917.1543	1/4" Bit socket spline (XZN), M6	1	128	917.1406	1/4" Hexagonal socket, 6 mm	1	157	911.1504	1/4" Extension with hexagon drive, 250 mm	1
100	917.1545	1/4" Bit socket spline (XZN), M8	1	129	917.1407	1/4" Hexagonal socket, 7 mm	1	158	911.1451	1/4" Extension with hexagon drive, 150 mm	1
101	917.1546	1/4" Bit socket spline (XZN), M10	1	130	917.1408	1/4" Hexagonal socket, 8 mm	1	159	911.1424	1/4" Extension with hexagon drive, 100 mm	1
102	917.1584	1/4" RIBE Socket M4	1	131	917.1409	1/4" Hexagonal socket, 9 mm	1	160	514.1126	1/4" 2in1 quick-replacement bit holder	1
103	917.1585	1/4" RIBE Socket M5S	1	132	917.1410	1/4" Hexagonal socket, 10 mm	1	161	911.1450	1/4" Universal joint	1
104	917.1586	1/4" RIBE Socket M6S	1	133	917.1411	1/4" Hexagonal socket, 11 mm	1	162	911.1423	1/4" Extension with hexagon drive, 50 mm	1
105	917.1587	1/4" RIBE Socket M7S	1	134	917.1412	1/4" Hexagonal socket, 12 mm	1	163	914.1410	Mini hand reversible ratchet, 1/4", 72 teeth	1
106	917.1588	1/4" RIBE Socket M8S	1	135	917.1413	1/4" Hexagonal socket, 13 mm	1	164	911.1434	1/4" Square drive screwdriver, 150 mm	1
107	917.1590	1/4" RIBE Socket M10S	1	136	911.4313	1/4" Torx E Socket, E4	1	165	917.1488	1/4" Flexible handle	1
108	911.1483	1/4" Bit socket, PZ0	1	137	911.4314	1/4" Torx E Socket, E5	1	166	911.1510	Mini-reversible ratchet, 1/4", 72 teeth	1
109	911.1401	1/4" Bit socket, PZ1	1	138	911.4315	1/4" Torx E Socket, E6	1	167	920.1490	1/4" SlimPOWER Reversible ratchet, 72 teeth	1
110	911.1402	1/4" Bit socket, PZ2	1	139	911.4316	1/4" Torx E Socket, E7	1	168	914.1405	1/4" MODIFIX mini T-handle swivel head ratchet, 72 teeth	1
111	911.1403	1/4" Bit socket, PZ3	1	140	911.4317	1/4" Torx E Socket, E8	1	169	516.1412	1/4" ERGOTORQUE® precision torque wrench with rotary mushroom ratchet head, 5-25Nm	1
112	917.2443	1/4" Hex bit socket, ball ended, 1/4", 3 mm	1	141	911.4332	1/4" Torx E Socket, E10	1				
113	917.2444	1/4" Hex bit socket, ball ended, 1/4", 4 mm	1	142	917.1461	1/4" 12 Point socket, 4 mm	1				
114	917.2445	1/4" Hex bit socket, ball ended, 1/4", 5 mm	1	143	917.1462	1/4" 12 Point socket, 4,5 mm	1				
115	917.24455	1/4" Hex bit socket, ball ended, 1/4", 5,5 mm	1	144	917.1463	1/4" 12 Point socket, 5 mm	1				
116	917.2446	1/4" Hex bit socket, ball ended, 1/4", 6 mm	1	145	917.1464	1/4" 12 Point socket, 5,5 mm	1				

M 1/2" Screwdriver bit set



64



568 x 398



P10



P10TC



P15



P20



P30



P35



P45

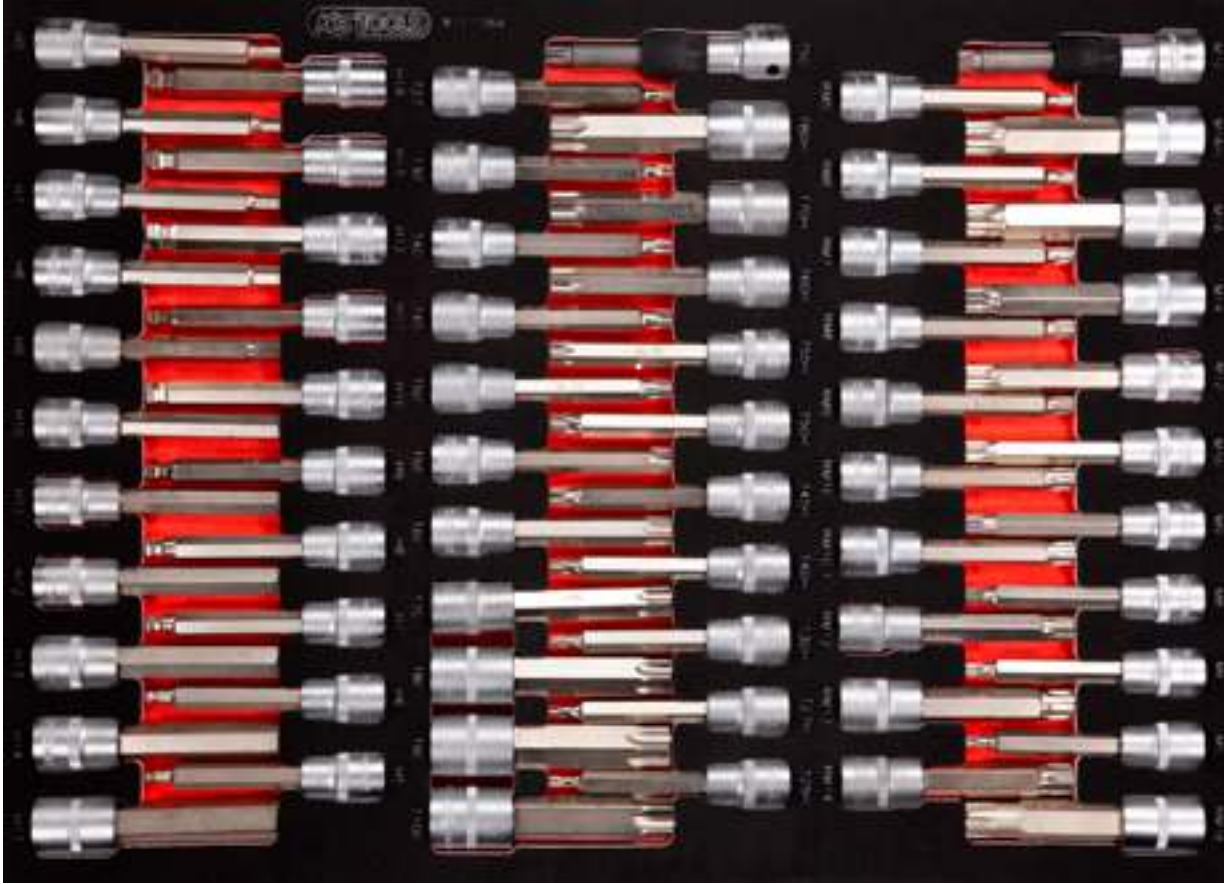

Pos.	Code	Description	pcs	Pos.	Code	Description	pcs	Pos.	Code	Description	pcs
1	911.1325	1/2" Bit socket hexagon, long, 5 mm	1	12	911.1697	Hex bit socket, ball ended, long, 1/2", 14 mm	1	23	911.1524	1/2" Bit socket Torx, long, T30	1
2	911.1326	1/2" Bit socket hexagon, long, 6 mm	1	13	911.1696	Hex bit socket, ball ended, long, 1/2", 13 mm	1	24	911.1525	1/2" Bit socket Torx, long, T40	1
3	911.1327	1/2" Bit socket hexagon, long, 7 mm	1	14	911.1662	Hex bit socket, ball ended, long, 1/2", 12 mm	1	25	911.1526	1/2" Bit socket Torx, long, T45	1
4	911.1328	1/2" Bit socket hexagon, long, 8 mm	1	15	911.1695	Hex bit socket, ball ended, long, 1/2", 11 mm	1	26	911.1527	1/2" Bit socket Torx, long, T50	1
5	911.1329	1/2" Bit socket hexagon, long, 9 mm	1	16	911.1660	Hex bit socket, ball ended, long, 1/2", 10 mm	1	27	911.1528	1/2" Bit socket Torx, long, T55	1
6	911.1330	1/2" Bit socket hexagon, long, 10 mm	1	17	911.1659	Hex bit socket, ball ended, long, 1/2", 9 mm	1	28	911.1529	1/2" Bit socket Torx, long, T60	1
7	911.5353	1/2" Bit socket hexagon, long, 11 mm	1	18	911.1658	Hex bit socket, ball ended, long, 1/2", 8 mm	1	29	911.1517	1/2" Bit socket Torx, long, T70	1
8	911.1332	1/2" Bit socket hexagon, long, 12 mm	1	19	911.1657	Hex bit socket, ball ended, long, 1/2", 7 mm	1	30	911.5308	1/2" Bit socket Torx, long, T80	1
9	911.5354	1/2" Bit socket hexagon, long, 13 mm	1	20	911.1656	Hex bit socket, ball ended, long, 1/2", 6 mm	1	31	911.5389	TX bit socket deep, 1/2", T90	1
10	917.1332	1/2" Bit socket hexagon, long, 14 mm	1	21	911.1655	Hex bit socket, ball ended, long, 1/2", 5 mm	1	32	911.5388	1/2" Bit socket Torx, long, T100	1
11	911.1337	1/2" Bit socket hexagon, long, 17 mm	1	22	911.1523	1/2" Bit socket Torx, long, T27	1	33	911.1632	1/2" Bit socket Torx tamperproof, long, TB80	1

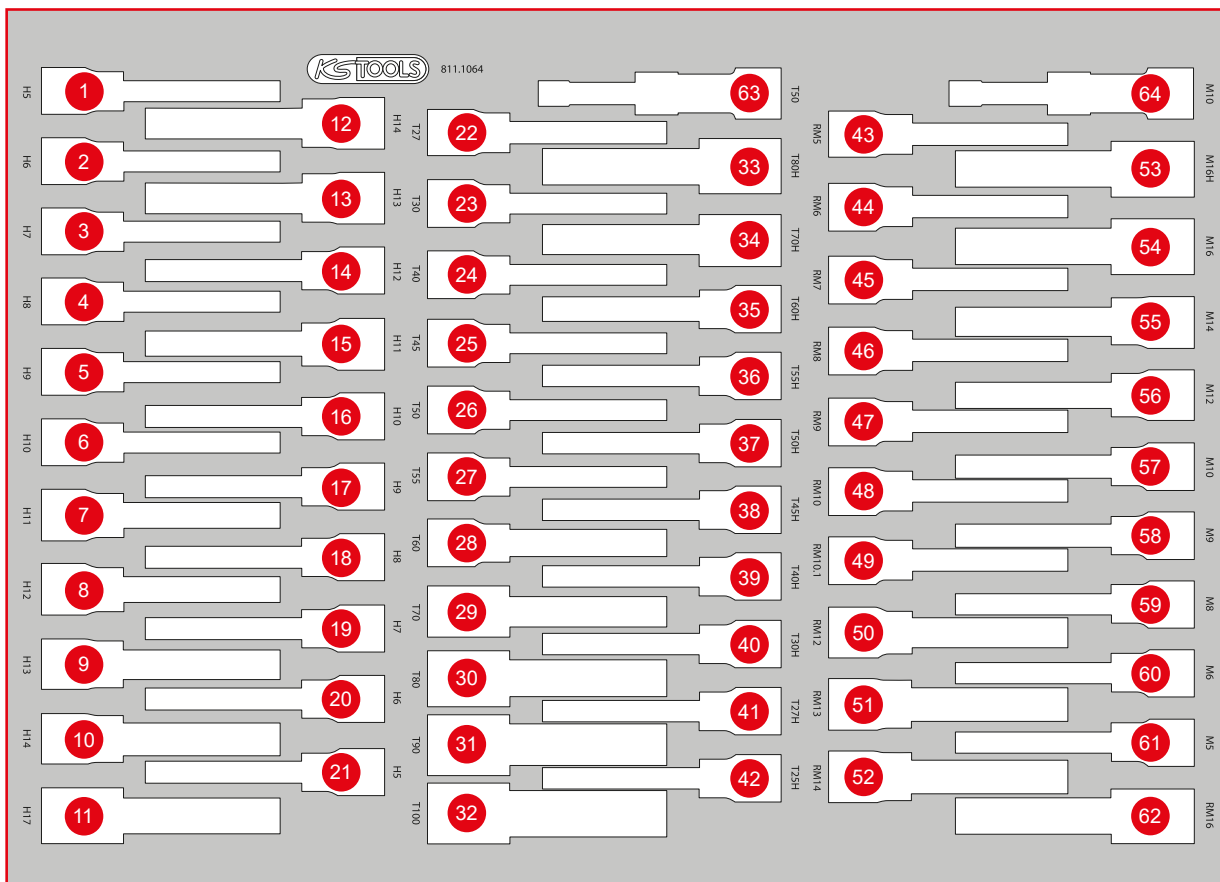

Pos.	Code	Description	pcs	Pos.	Code	Description	pcs	Pos.	Code	Description	pcs
34	917.1304	1/2" Bit socket Torx tamperproof, long, TB70	1	45	911.1923	1/2" Bit socket RIBE, M7, 110 mm	1	56	911.1354	1/2" Bit socket spline (XZN), M12, 110 mm	1
35	917.1253	1/2" Bit socket Torx tamperproof, long, TB60	1	46	911.1924	1/2" Bit socket RIBE, M8, 110 mm	1	57	911.1353	1/2" Bit socket spline (XZN), M10, 110 mm	1
36	917.1251	1/2" Bit socket Torx tamperproof, long, TB55	1	47	911.1925	1/2" Bit socket RIBE, M9, 110 mm	1	58	911.1359	1/2" Bit socket spline (XZN), M9, 110 mm	1
37	917.1299	1/2" Bit socket Torx tamperproof, long, TB50	1	48	911.1926	1/2" Bit socket RIBE, M10, 110 mm	1	59	911.1352	1/2" Bit socket spline (XZN), M8, 110 mm	1
38	917.1298	1/2" Bit socket Torx tamperproof, long, TB45	1	49	911.4554	1/2" Bit socket RIBE, M10.1, 110 mm	1	60	911.1351	1/2" Bit socket spline (XZN), M6, 110 mm	1
39	917.1297	1/2" Bit socket Torx tamperproof, long, TB40	1	50	911.1995	1/2" Bit socket RIBE, M12, 110 mm	1	61	911.1350	1/2" Bit socket spline (XZN), M5, 110 mm	1
40	917.1296	1/2" Bit socket Torx tamperproof, long, TB30	1	51	911.1996	1/2" Bit socket RIBE, M13, 110 mm	1	62	911.4553	1/2" Bit socket RIBE, M16, 110 mm	1
41	917.1295	1/2" Bit socket Torx tamperproof, long, TB27	1	52	911.1997	1/2" Bit socket RIBE, M14, 110 mm	1	63	150.3101	1/2" V-Ribbed Alternator combination key Torx, T50	1
42	917.1294	1/2" Bit socket Torx tamperproof, long, TB25	1	53	911.5392	XZN bit socket, 1/2", deep, MB16	1	64	150.3102	1/2" V-Ribbed Alternator combination key XZN, M10, 115 mm	1
43	911.1921	1/2" Bit socket RIBE, M5, 110 mm	1	54	911.1356	1/2" Bit socket spline (XZN), M16, 110 mm	1				
44	911.1922	1/2" Bit socket RIBE, M6, 110 mm	1	55	911.1355	1/2" Bit socket spline (XZN), M14, 110 mm	1				

M Screw spanner set

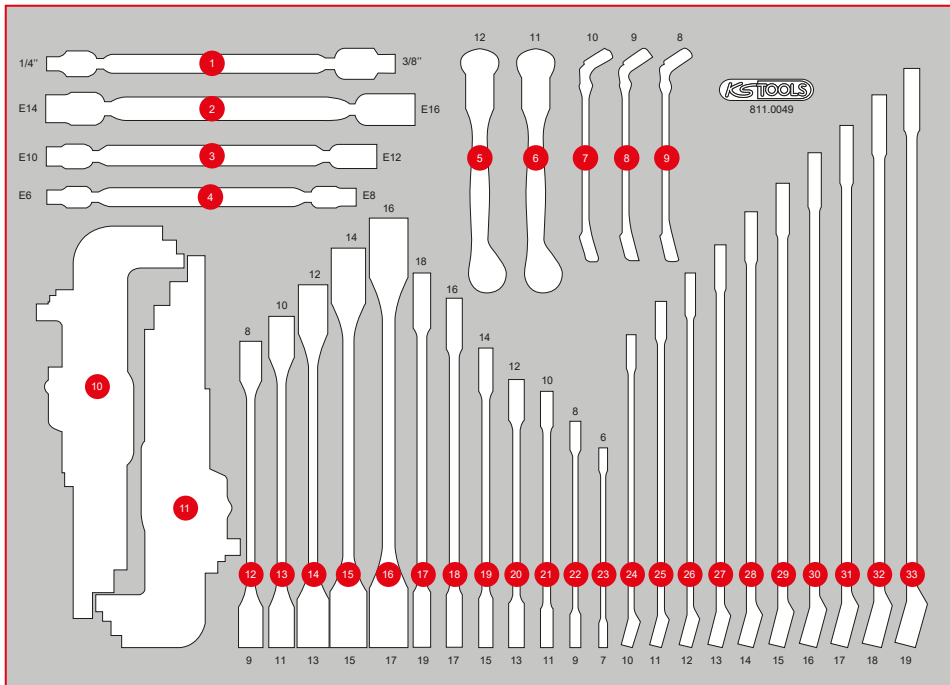

Pos.	Code	Description	pcs
1	517.0338	Double-joint-spanner for 1/4" and 3/8" sockets	1
2	517.0333	Double revolving head spanner for Torx E profile, E14 x E16	1
3	517.0332	Double revolving head spanner for Torx E profile, E10 x E12	1
4	517.0330	Double revolving head spanner for Torx E profile, E6 x E8	1
5	518.0382	CHROMEplus Open double ring spanner, with flexible joint, 12 mm	1
6	518.0381	CHROMEplus Open double ring spanner, with flexible joint, 11 mm	1
7	518.0380	CHROMEplus Open double ring spanner, with flexible joint, 10 mm	1
8	518.0379	CHROMEplus Open double ring spanner, with flexible joint, 9 mm	1
9	518.0378	CHROMEplus Open double ring spanner, with flexible joint, 8 mm	1
10	151.4420	Ball ended hexagon key wrench set, extra long, 9 pcs	9
11	151.5210	Ball head Torx angled socket wrench set, extra long, 9 pcs	9
12	517.0301	Double revolving head spanner, 8 x 9 mm	1
13	517.0302	Double revolving head spanner, 10 x 11 mm	1
14	517.0303	Double revolving head spanner, 12 x 13 mm	1
15	517.0304	Double revolving head spanner, 14 x 15 mm	1
16	517.0305	Double revolving head spanner, 16 x 17 mm	1
17	920.0418	ULTIMATEplus Double ring ended spanner, 18 x 19 mm	1
18	920.0416	ULTIMATEplus Double ring ended spanner, 16 x 17 mm	1
19	920.0414	ULTIMATEplus Double ring ended spanner, 14 x 15 mm	1
20	920.0412	ULTIMATEplus Double ring ended spanner, 12 x 13 mm	1
21	920.0410	ULTIMATEplus Double ring ended spanner, 10 x 11 mm	1
22	920.0408	ULTIMATEplus Double ring ended spanner, 8 x 9 mm	1
23	920.0406	ULTIMATEplus Double ring ended spanner, 6 x 7 mm	1
24	519.0650	CHROMEplus Combination spanner, extra long, 10 mm	1
25	519.0651	CHROMEplus Combination spanner, extra long, 11 mm	1
26	519.0652	CHROMEplus Combination spanner, extra long, 12 mm	1
27	519.0653	CHROMEplus Combination spanner, extra long, 13 mm	1
28	519.0654	CHROMEplus Combination spanner, extra long, 14 mm	1
29	519.0655	CHROMEplus Combination spanner, extra long, 15 mm	1
30	519.0656	CHROMEplus Combination spanner, extra long, 16 mm	1
31	519.0657	CHROMEplus Combination spanner, extra long, 17 mm	1
32	519.0658	CHROMEplus Combination spanner, extra long, 18 mm	1
33	519.0659	CHROMEplus Combination spanner, extra long, 19 mm	1

811.1018

M T-handle key wrench set

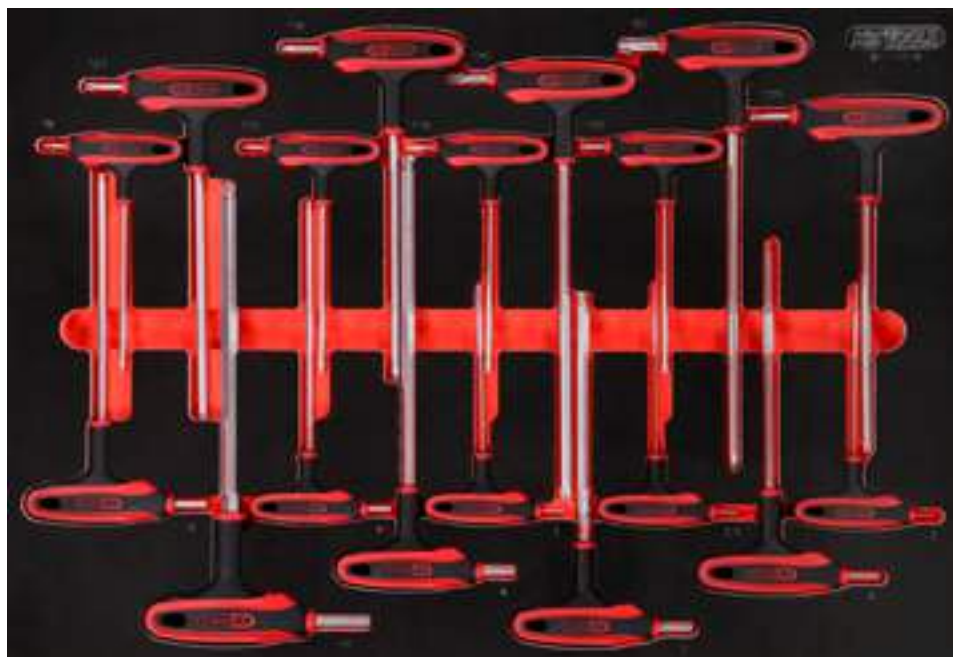

Pos.	Code	Description	pcs
1	151.2753	T-handle Torx key wrench, ball end, T8	1
2	151.2759	T-handle Torx key wrench, ball end, T27	1
3	151.2755	T-handle Torx key wrench, ball end, T10	1
4	151.2760	T-handle Torx key wrench, ball end, T30	1
5	151.2756	T-handle Torx key wrench, ball end, T15	1
6	151.2761	T-handle Torx key wrench, ball end, T40	1
7	151.2757	T-handle Torx key wrench, ball end, T20	1
8	151.2853	T-handle Torx key wrench, ball end, T50	1
9	151.2758	T-handle Torx key wrench, ball end, T25	1
10	151.8134	T-handle ball ended hexagon key wrench, 5 mm	1
11	151.8138	T-handle ball ended hexagon key wrench, 10 mm	1
12	151.8133	T-handle ball ended hexagon key wrench, 4 mm	1
13	151.8137	T-handle ball ended hexagon key wrench, 8 mm	1
14	151.8132	T-handle ball ended hexagon key wrench, 3 mm	1
15	151.8136	T-handle ball ended hexagon key wrench, 7 mm	1
16	151.8131	T-handle ball ended hexagon key wrench, 2,5 mm	1
17	151.8135	T-handle ball ended hexagon key wrench, 6 mm	1
18	151.8130	T-handle ball ended hexagon key wrench, 2 mm	1

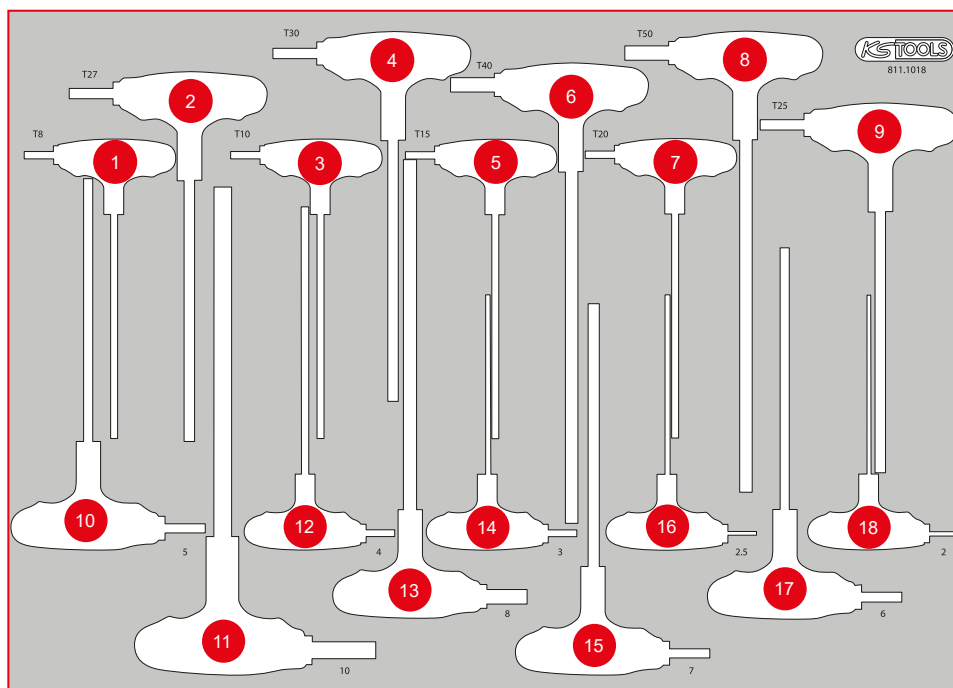

M T-handle key wrench set



Pos.	Code	Description	pcs
1	158.5006	T-handle socket screwdriver, long, 6 mm	1
2	158.5010	T-handle socket screwdriver, long, 10 mm	1
3	158.5007	T-handle socket screwdriver, long, 7 mm	1
4	158.5012	T-handle socket screwdriver, long, 12 mm	1
5	158.5008	T-handle socket screwdriver, long, 8 mm	1
6	158.5013	T-handle socket screwdriver, long, 13 mm	1
7	158.5009	T-handle socket screwdriver, long, 9 mm	1
8	159.1126	ERGOTORQUEplus Socket screwdriver, 6 mm	1
9	159.1204	ERGOTORQUEplus Socket screwdriver, 6 mm	1
10	159.1205	ERGOTORQUEplus Socket screwdriver, 7 mm	1
11	159.1206	ERGOTORQUEplus Socket screwdriver, 8 mm	1
12	159.1207	ERGOTORQUEplus Socket screwdriver, 9 mm	1
13	159.1208	ERGOTORQUEplus Socket screwdriver, 10 mm	1
14	159.1209	ERGOTORQUEplus Socket screwdriver, 11 mm	1
15	159.1210	ERGOTORQUEplus Socket screwdriver, 12 mm	1
16	159.1211	ERGOTORQUEplus Socket screwdriver, 13 mm	1
17	159.1127	ERGOTORQUEplus Socket screwdriver, 7 mm	1
18	911.1128	ERGOTORQUE Socket screwdriver, 8 mm	1

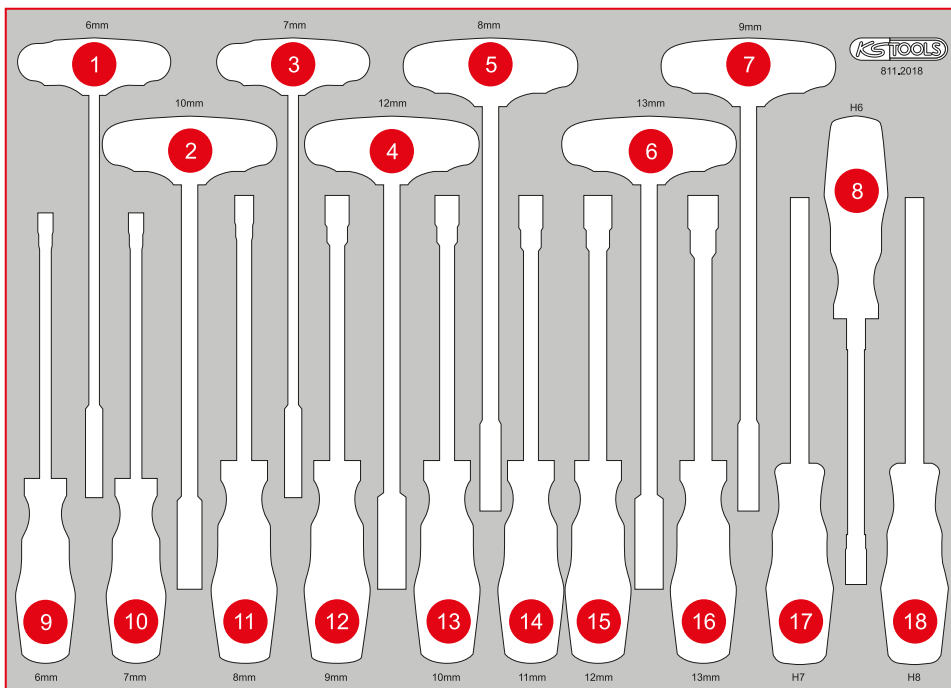

811.0028

M Measuring tool and file set



Pos.	Code	Description	pcs
1	300.0104	Flexible steel rule, 300 mm	1
2	300.0700	Protractor with rule, 220 mm	1
3	156.0466	Automatic centre punch, Ø 4 mm	1
4	300.0510	Pocket vernier calliper 0 - 150 mm, 235 mm	1
5	300.0600	Feeler gauge, 20 Blades, 0,05 - 1 mm	1
6	201.2335	Steel wire brake saddle brush, 2-row, straight 225 mm	1
7	300.0550	Digital depth gauge 0-25 mm, 125 mm	1
8	300.0114	Tape measure with locking device and belt clip, black red, 5 m, 19 mm	1
9	157.0105	Halfround file, form E, cut 2, 20 mm	1
10	157.0205	Round file, form F, cut 2, 200 mm	1
11	157.0005	Flat file, form B, cut 2, 200 mm	1
12	157.0405	Tri-bastard file, form C, cut 2, 200 mm	1
13	157.0960	Brake saddle file, extra narrow, 270 mm	1
14	911.8138	Trim plastic wedge, 195 mm x B = 30 mm	1
15	907.2115	Hacksaw frame, 300 mm	1
16	907.2166	Snap off blades 0,5 x 1,8 x 100 mm, dispenser with 10 pieces	10
17	907.2135	Universal snap off blade knife 18 mm	1
18	129.6620-24	HSS Bi Co 8 metal high performance saw blades 1,0 mm	1
19	911.8146	Tyre lever, 370 mm	1

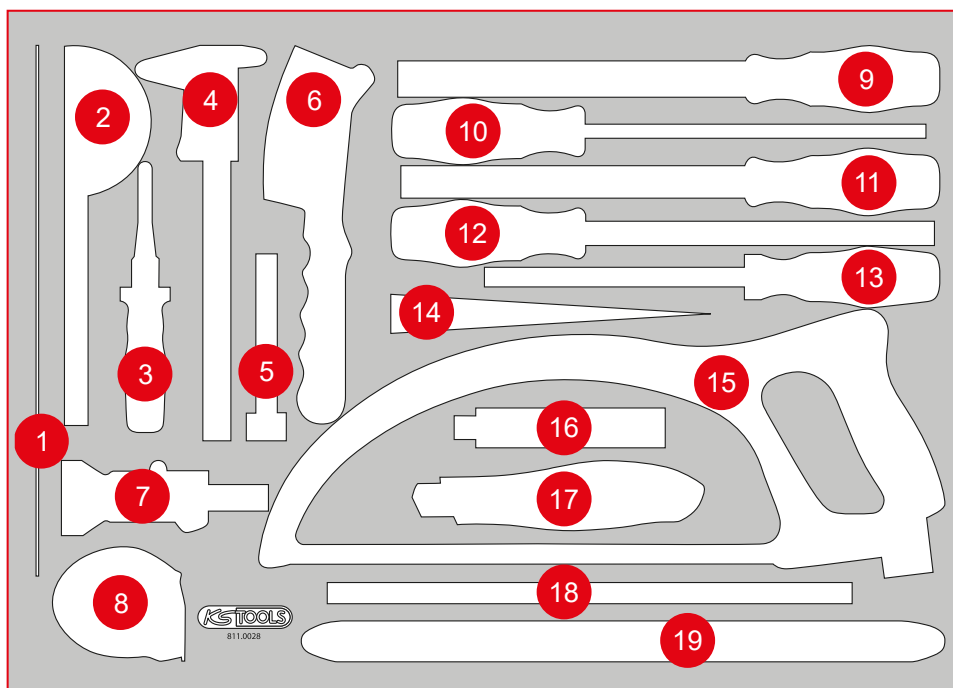

P45

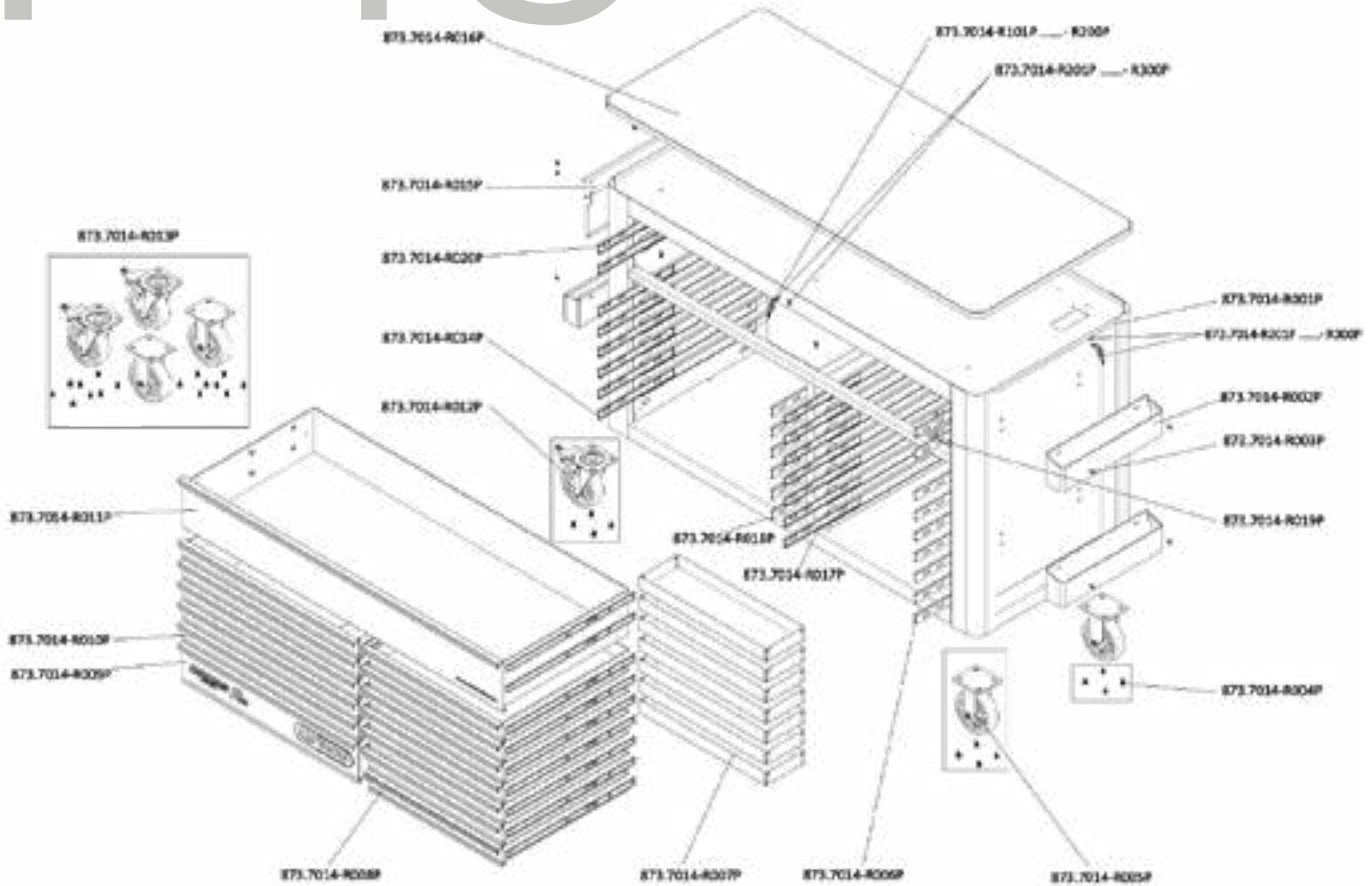

INDIVIDUAL PARTS LIST

Art.-Nr.	Description	amount
873.7014-R101P...	Replacement key for PERFORMANCEplus workshop trolley lock number xyz	2
873.7014-R201P...	Lock with 2 keys for PERFORMANCEplus workshop trolley lock number xyz	2
873.7014-R001P	Body with handle for workshop trolley P45	1
873.7014-R002P	Can holder for PERFORMANCEplus workshop trolley P20/P30/P35/P40/P45	3
873.7014-R003P	M6x12 screw (1 pcs.) for PERFORMANCEplus workshop trolley accessories	10
873.7014-R004P	M8 screws for PERFORMANCEplus workshop trolley rollers (16 pcs.)	1
873.7014-R005P	Fixed castors for workshop trolley P45, incl. screws	2
873.7014-R006P	Full extension (with ball-bearing guide) with automatic retraction	7
873.7014-R007P	Storage for compartments for workshop trolley P45	7
873.7014-R008P	Compartment with ball-bearing guide, 568x568x65 mm	7
873.7014-R009P	Compartment with logo and ball-bearing guide, 785x568x145 mm	1
873.7014-R010P	Compartment with ball-bearing guide, for workshop trolley P20/P30/P45, 785x568x65 mm	5
873.7014-R011P	Compartment with website and ball-bearing guide, 1429x568x180 mm	1
873.7014-R012P	Swivel castors for workshop trolley P45, incl. screws	2
873.7014-R013P	Roller set for workshop trolley P45, incl. screws	1
873.7014-R014P	Full extension (with ball-bearing guide) with automatic retraction	6
873.7014-R015P	Paper roll holder for PERFORMANCEplus workshop trolley P20/P30/P35/P40/P45	1
873.7014-R016P	Stainless steel work surface for workshop trolley P45	1
873.7014-R017P	Full extension (with ball-bearing guide) with automatic retraction	7
873.7014-R018P	Full extension (with ball-bearing guide) with automatic retraction	6
873.7014-R019P	Full extension (with ball-bearing guide) with automatic retraction	2
873.7014-R020P	Full extension (with ball-bearing guide) with automatic retraction	2



873.7014-R101P...R200P
Replacement key for lock number xyz



873.7014-R201P...R300P
Lock with 2 keys, lock number xyz



873.7014-R006P
Full extension (with ball-bearing guide) with automatic retraction, right



873.7014-R014P
Full extension (with ball-bearing guide) with automatic retraction, left



873.7014-R017P
Full extension (with ball-bearing guide) with automatic retraction, left



873.7014-R018P
Full extension with self-closing for drawer, right



873.7014-R019P
Full extension (with ball-bearing guide) with automatic retraction, right

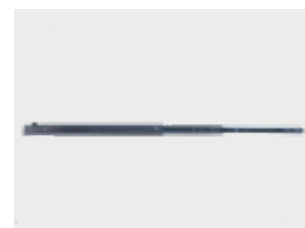

873.7014-R020P
Full extension with self-closing for drawer, left



873.7014-R005P
Fixed castors, incl. screws

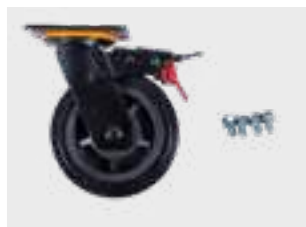

873.7014-R012P
Swivel castors with brakes, incl. screws

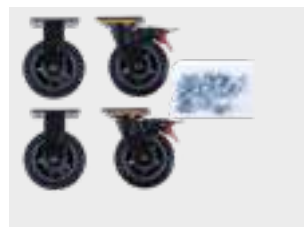

873.7014-R013P
Roller set, incl. screws



873.7014-R016P
Stainless steel work surface



873.7014-R011P
Compartment with website and ball-bearing guide, 1429x568x180 mm



873.7014-R008P
Compartment with ball-bearing guide, 568x568x65 mm



873.7014-R010P
Compartment with ball-bearing guide, 785x568x65 mm



873.7014-R009P
Compartment with logo and ball-bearing guide, 785x568x145 mm



873.7014-R007P
Storage for compartments



873.7014-R002P
Can holder including screws, W = 445 mm



873.7014-R015P
Paper roll holder including screws, W= 400 mm



873.7014-R004P
M8 screws (16 pcs.)



873.7014-R003P
M6x12 screw (1 pcs.)



873.7014-R001P
Body of workshop trolley attachment

